



RIGOL

DS70000 Series

Digital Oscilloscope

User Guide

Nov. 2022

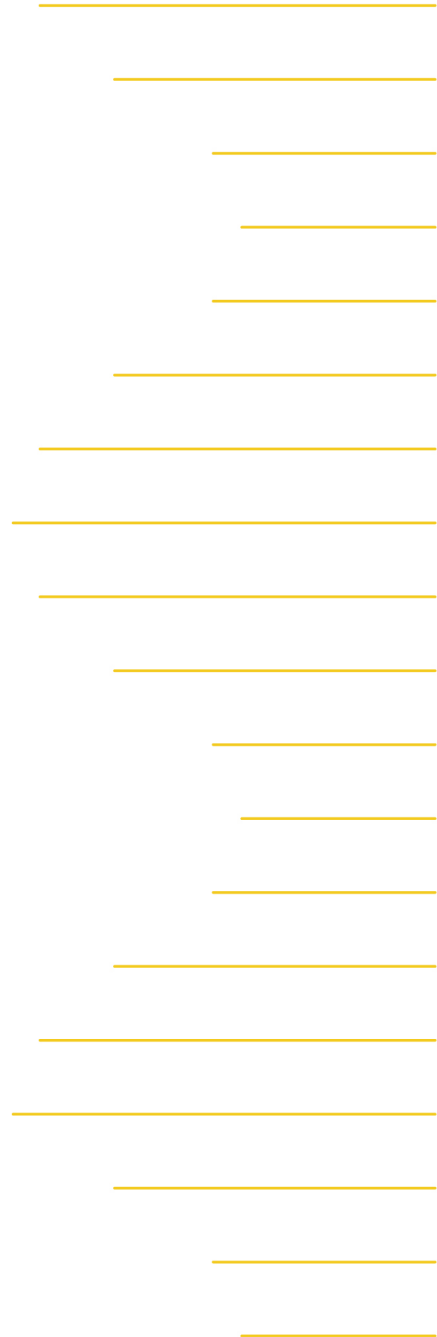

Guaranty and Declaration

Copyright

© 2022 RIGOL TECHNOLOGIES CO., LTD. All Rights Reserved.

Trademark Information

RIGOL® is the trademark of RIGOL TECHNOLOGIES CO., LTD.

Notices

- RIGOL products are covered by P.R.C. and foreign patents, issued and pending.
- RIGOL reserves the right to modify or change parts of or all the specifications and pricing policies at the company's sole decision.
- Information in this publication replaces all previously released materials.
- Information in this publication is subject to change without notice.
- RIGOL shall not be liable for either incidental or consequential losses in connection with the furnishing, use, or performance of this manual, as well as any information contained.
- Any part of this document is forbidden to be copied, photocopied, or rearranged without prior written approval of RIGOL.

Product Certification

RIGOL guarantees that this product conforms to the national and industrial standards in China as well as the ISO9001:2015 standard and the ISO14001:2015 standard. Other international standard conformance certifications are in progress.

Contact Us

If you have any problem or requirement when using our products or this manual, please contact RIGOL.

E-mail: service@rigol.com

Website: <http://www.rigol.com>

Section	Description	Page
	List of Figures.....	VIII
	List of Tables.....	XIV
1	Safety Requirement.....	1
1.1	General Safety Summary.....	1
1.2	Safety Notices and Symbols.....	3
1.3	Measurement Category.....	3
1.4	Ventilation Requirement.....	4
1.5	Working Environment.....	4
1.6	Care and Cleaning.....	6
1.7	Environmental Considerations.....	6
1.8	Keep Hands Clear.....	7
2	Product Features.....	8
3	Document Overview.....	10
4	Quick Start.....	12
4.1	General Inspection.....	12
4.2	Appearance and Dimensions.....	13
4.3	To Prepare for Use.....	14
4.3.1	To Connect to AC Power.....	14
4.3.2	Turn-on Checkout.....	14
4.3.3	To Set the System Language.....	15
4.3.4	To Connect the Probe.....	15
4.3.5	Function Inspection.....	18
4.3.6	Probe Compensation.....	19
4.4	Product Overview.....	20
4.4.1	Front Panel Overview.....	20
4.4.2	Rear Panel Overview.....	23
4.4.3	User Interface.....	25
4.4.4	Secondary 3.5-inch Touch Screen.....	27
4.5	Touch Screen Gestures.....	31
4.5.1	Tap.....	31
4.5.2	Pinch&Stretch.....	32
4.5.3	Drag.....	32
4.6	Parameter Setting Method.....	33

4.7	To Use the Built-in Help System.....	39
4.8	To View the Option Information and the Option Installation.....	40
5	To Set the Vertical System.....	42
5.1	To Enable or Disable the Analog Channel.....	42
5.2	To Adjust the Vertical Scale.....	43
5.3	To Adjust the Vertical Offset.....	45
5.4	Channel Coupling.....	46
5.5	BW Limit.....	46
5.6	Input Impedance.....	47
5.7	Waveform Invert.....	48
5.8	Probe.....	49
5.9	Amplitude Unit.....	52
5.10	Bias.....	53
5.11	Channel Delay.....	53
5.12	Channel Label.....	54
6	To Set the Horizontal System.....	55
6.1	To Adjust the Horizontal Time Base.....	56
6.2	To Adjust the Horizontal Position.....	56
6.3	Delayed Sweep.....	57
7	To Set the Sample System.....	59
7.1	Acquisition Mode.....	59
7.2	Sampling Mode.....	61
7.3	Sample Rate.....	61
7.4	Memory Depth.....	62
7.5	Anti-Aliasing.....	64
7.6	Horizontal Expansion.....	64
7.7	Roll Mode.....	65
7.8	XY Mode.....	65
8	To Trigger the Oscilloscope.....	68
8.1	Trigger Source.....	68
8.2	Trigger Level.....	69
8.3	Trigger Mode.....	70
8.4	Trigger Coupling.....	71
8.5	Trigger Holdoff.....	72
8.6	Noise Rejection.....	73
8.7	Trigger Type.....	73
8.7.1	Edge Trigger.....	73

8.7.2	Pulse Trigger.....	75
8.7.3	Slope Trigger.....	78
8.7.4	Video Trigger.....	82
8.7.5	Pattern Trigger.....	84
8.7.6	Duration Trigger.....	87
8.7.7	Timeout Trigger.....	90
8.7.8	Runt Trigger.....	92
8.7.9	Window Trigger.....	95
8.7.10	Delay Trigger.....	98
8.7.11	Setup/Hold Trigger.....	101
8.7.12	Nth Edge Trigger.....	105
8.7.13	RS232 Trigger (Option).....	107
8.7.14	I2C Trigger (Optional).....	110
8.7.15	SPI Trigger (Option).....	114
8.7.16	CAN Trigger (Option).....	118
8.7.17	FlexRay Trigger (Option).....	122
8.7.18	LIN Trigger (Option).....	125
8.7.19	I2S Trigger (Option).....	128
8.7.20	MIL-STD-1553 Trigger (Option).....	132
8.8	Trigger Output Connector.....	137
9	Math Operation.....	138
9.1	Arithmetic Operation.....	140
9.2	Function Operation.....	143
9.3	FFT Operation.....	146
9.4	Logic Operation.....	152
9.5	Digital Filter.....	155
10	Measure.....	159
10.1	Measurement Parameter.....	159
10.1.1	Time Parameters.....	160
10.1.2	Count Values.....	161
10.1.3	Delay and Phase Parameters.....	162
10.1.4	Voltage Parameters.....	164
10.1.5	Other Parameters.....	166
10.2	To Select the Measurement Item.....	166
10.3	Measurement Settings.....	169
10.4	Remove the Measurement Results.....	172
10.5	Auto Measurement.....	172

10.6	Cursor Measurement.....	174
10.6.1	Manual Mode.....	176
10.6.2	Track Mode.....	178
10.6.3	XY Mode.....	181
11	Digital Voltmeter (DVM) and Frequency Counter.....	183
11.1	Digital Voltmeter (DVM).....	183
11.1.1	Measurement Settings.....	184
11.1.2	Remove the Measurement.....	185
11.2	Frequency Counter.....	185
11.2.1	Measurement Settings.....	186
11.2.2	Reset Statistics.....	187
11.2.3	Remove the Measurement.....	187
12	Real-time Eye Analysis (Option).....	188
12.1	To Enable or Disable the Eye Analysis Function.....	189
12.2	To Select the Source of the Eye Diagram.....	189
12.3	Threshold Settings.....	189
12.4	To Set Clock Recovery.....	190
12.5	To Set the Data Rate.....	191
12.6	Eye Measurement Result.....	191
12.7	To Set the Display-related Parameters.....	193
13	Jitter Analysis (Option).....	194
13.1	To Enable or Disable the Jitter Function.....	195
13.2	To Set Parameters.....	195
13.3	To View the Jitter Measurement.....	196
14	Reference Waveform.....	198
14.1	To Enable Ref Function.....	198
14.2	To Set the Reference Waveform.....	199
14.3	To Set the Ref Waveform Display.....	199
14.4	Export and Import Operation.....	200
15	Pass/Fail Test.....	203
15.1	To Enable or Disable the Pass/Fail Test Function.....	203
15.2	To Start or Stop the Pass/Fail Test Operation.....	204
15.3	To Select the Source.....	204
15.4	Mask.....	204
15.5	To Set the Output Form of the Test Results.....	205
15.6	Display of the Statistics of the Test Results.....	206
16	RTSA (Option).....	207

16.1	Basic Settings.....	207
16.1.1	FREQ.....	208
16.1.2	SPAN.....	209
16.1.3	BW.....	209
16.1.4	AMPT.....	210
16.2	Peak Search.....	211
17	Protocol Decoding.....	213
17.1	Parallel Decoding.....	213
17.1.1	Clock Setting (CLK).....	215
17.1.2	Bus Setting.....	215
17.1.3	Display-related Setting.....	216
17.1.4	Event Table.....	216
17.2	RS232 Decoding (Option).....	217
17.2.1	Source Setting.....	219
17.2.2	To Set Data Package.....	220
17.2.3	Display-related Setting.....	221
17.2.4	Event Table.....	221
17.3	I2C Decoding (Option).....	222
17.3.1	Source Setting.....	223
17.3.2	Display-related Setting.....	224
17.3.3	Event Table.....	224
17.4	SPI Decoding (Option).....	226
17.4.1	To Set the Source.....	227
17.4.2	To Set Mode and Data.....	227
17.4.3	Display-related Setting.....	228
17.4.4	Event Table.....	229
17.5	LIN Decoding (Option).....	230
17.5.1	Signal Configuration.....	231
17.5.2	Display-related Setting.....	231
17.5.3	Event Table.....	231
17.6	CAN Decoding (Option).....	233
17.6.1	Signal Configuration.....	233
17.6.2	Display-related Setting.....	235
17.6.3	Event Table.....	235
17.7	FlexRay Decoding (Option).....	237
17.7.1	Signal Configuration.....	238
17.7.2	Display-related Setting.....	239

17.7.3	Event Table.....	239
17.8	I2S Decoding (Option).....	240
17.8.1	Source Setting.....	241
17.8.2	Bus Setting.....	242
17.8.3	Display-related Setting.....	242
17.8.4	Event Table.....	243
17.9	1553B Decoding (Option).....	244
17.9.1	To Set the Data Channel Source and the Threshold.....	245
17.9.2	Display-related Setting.....	245
17.9.3	Event Table.....	245
18	Serial Bus Compliance Analysis (Option).....	248
18.1	USB2.0 Compliance Analysis.....	248
18.1.1	DUT.....	248
18.1.2	Test Selection.....	250
18.1.3	Analysis Setting.....	253
18.1.4	Result Export.....	254
18.2	LAN Compliance Analysis.....	256
18.2.1	To Select the Signal Type.....	257
18.2.2	To Select the Test Item.....	257
18.2.2.1	100Base-T Signal Test Items.....	258
18.2.2.2	1000Base-T Signal Test Items.....	259
18.2.3	Configuration Menu.....	264
18.2.3.1	To Configure the Source.....	264
18.2.3.2	Connection Diagram.....	266
18.2.3.3	Fixture Calibration.....	267
18.2.3.4	To Launch the Test.....	269
18.2.4	Result Report.....	270
19	Multi-pane Windowing.....	272
20	Waveform Recording and Playing.....	274
20.1	Common Settings.....	274
20.2	Record Options.....	275
20.3	Play Option.....	276
21	Display Control.....	279
21.1	Display Type.....	279
21.2	Persistence Time.....	280
21.3	Intensity.....	280
21.4	To Set the Screen Grid.....	281

21.5	Display Setting.....	281
21.6	Show Scale.....	281
21.7	Color Grade.....	281
21.8	Waveform Freeze.....	281
22	Storage.....	283
22.1	To Enter the Storage Menu.....	283
22.2	To Save a File.....	283
22.2.1	Save Image.....	283
22.2.2	Save Wave.....	285
22.2.3	Save Setup.....	287
22.2.4	Binary Data Format (.bin).....	289
22.3	Load a File.....	292
22.4	System Upgrade.....	293
22.5	Disk Management.....	294
22.6	Factory Settings.....	296
23	System Utility Function Setting.....	305
23.1	I/O Setting.....	305
23.2	Basic Settings.....	307
23.3	About this Oscilloscope.....	310
23.4	Other Setting.....	310
23.5	SelfCal.....	311
23.6	Option List.....	311
23.7	Quick Settings.....	312
23.8	Self-check.....	314
24	Remote Control.....	318
24.1	Remote Control via USB.....	319
24.2	Remote Control via LAN.....	319
24.3	Remote Control via GPIB.....	320
25	Troubleshooting.....	322
26	Appendix.....	324
26.1	Appendix A: Options and Accessories.....	324
26.2	Appendix B: Warranty.....	325

List of Figures

Figure 4.1 Front View	13
Figure 4.2 Side View	13
Figure 4.3 To Connect to AC Power	14
Figure 4.4 Connect the Passive Probe	16
Figure 4.5 To Connect the Probe Head to the PA of the Active Probe	17
Figure 4.6 Connect the Active Probe	17
Figure 4.7 To Use the Compensation Signal	18
Figure 4.8 Waveform Signal	19
Figure 4.9 Probe Compensation	19
Figure 4.10 Front Panel	20
Figure 4.11 Rear Panel	23
Figure 4.12 User Interface	25
Figure 4.13 Smart Quick-Responsive Shortcut Key Menu Display	28
Figure 4.14 Flip Screen Adjustment Interface	30
Figure 4.15 Tap Gesture	32
Figure 4.16 Pinch&Stretch Gesture	32
Figure 4.17 Drag Gesture	33
Figure 4.18 English Input Interface	34
Figure 4.19 Chinese Input Interface	35
Figure 4.20 String Keypad	37
Figure 4.21 Numeric Keypad	38
Figure 4.22 Help Information	39
Figure 5.1 Vertical Menu for Channel	42
Figure 5.2 Input Impedance Modification	48
Figure 5.3 Waveform Invert	49
Figure 5.4 Probe Setting Menu	49
Figure 5.5 RP7000/PVA7000/PVA8000 Probe Setting Menu	50

Figure 5.6 SelfCal	52
Figure 5.7 Zero Offset	54
Figure 6.1 Horizontal System Menu	55
Figure 6.2 Delayed Sweep Mode	58
Figure 7.1 Horizontal System Menu	59
Figure 7.2 Memory Depth	63
Figure 7.3 XY Setting Menu	66
Figure 7.4 Measurement Schematic Diagram of Phase Deviation	67
Figure 8.1 Schematic Diagram of the Acquisition Memory	70
Figure 8.2 Trigger Holdoff	72
Figure 8.3 Edge Trigger Setting Menu	74
Figure 8.4 Positive Pulse Width/Negative Pulse Width	76
Figure 8.5 Pulse Trigger Setting Menu	76
Figure 8.6 Positive Slope Time/Negative Slope Time	79
Figure 8.7 Slope Trigger Setting Menu	79
Figure 8.8 Video Trigger Setting Menu	82
Figure 8.9 Pattern Trigger	85
Figure 8.10 Pattern Trigger Setting Menu	85
Figure 8.11 Duration Trigger	87
Figure 8.12 Duration Trigger Setting Menu	88
Figure 8.13 Timeout Trigger	90
Figure 8.14 Timeout Trigger Menu	91
Figure 8.15 Runt Trigger	93
Figure 8.16 Runt Trigger Setting Menu	93
Figure 8.17 Window Trigger Setting Menu	96
Figure 8.18 Delay Trigger	98
Figure 8.19 Delay Trigger Setting Menu	99
Figure 8.20 Setup/Hold Trigger	102
Figure 8.21 Setup/Hold Trigger Setting Menu	103

Figure 8.22 Nth Edge Trigger	105
Figure 8.23 Nth Edge Trigger Setting Menu	106
Figure 8.24 Schematic Diagram of RS232 Protocol	108
Figure 8.25 RS232 Trigger Setting Menu	108
Figure 8.26 Schematic Diagram of I2C Protocol	110
Figure 8.27 I2C Trigger Setting Menu	111
Figure 8.28 Bin Format Setting	113
Figure 8.29 Hex Format Setting	113
Figure 8.30 Sequential Chart of SPI Bus	115
Figure 8.31 SPI Trigger Setting Menu	115
Figure 8.32 Data Frame Format of the CAN Bus	118
Figure 8.33 CAN Trigger Setting Menu	119
Figure 8.34 Sample Position	120
Figure 8.35 Frame Format of FlexRay Bus	122
Figure 8.36 FlexRay Trigger Setting Menu	123
Figure 8.37 Data Frame Format of the LIN Bus	125
Figure 8.38 LIN Trigger Setting Menu	126
Figure 8.39 Sample Position	127
Figure 8.40 Sequential Chart of I2S Bus	129
Figure 8.41 I2S Trigger Setting Menu	129
Figure 8.42 Formats of the Command Word, Data Word, and Status Word of the 1553B Bus	133
Figure 8.43 MIL-STD-1553 Trigger Setting Menu	134
Figure 9.1 Math Operation Menu	139
Figure 9.2 Waveform Display Window of the Operation Results	140
Figure 9.3 Arithmetic Operation Menu	141
Figure 9.4 Operation Result Display Window	142
Figure 9.5 Function Operation Menu	144
Figure 9.6 Operation Result Display Window	145

Figure 9.7 FFT Operation Menu	147
Figure 9.8 FFT Operation Window	148
Figure 9.9 Peak Search	151
Figure 9.10 Logic Operation Menu	152
Figure 9.11 Operation Result Display Window	154
Figure 9.12 Digital Filter Menu	156
Figure 9.13 Operation Result Display Window	157
Figure 10.1 Time Parameters	160
Figure 10.2 Delay and Phase Parameters	162
Figure 10.3 Voltage Parameters	164
Figure 10.4 Vertical Measurement Items	167
Figure 10.5 Horizontal Measurement Items	168
Figure 10.6 Other Measurement Items	168
Figure 10.7 Measurement Settings	169
Figure 10.8 Cursor	174
Figure 10.9 Cursor Measurement Result	175
Figure 10.10 Manual Mode Setting Menu	176
Figure 10.11 Manual Cursor Measurement Example	178
Figure 10.12 Track Mode Setting Menu	179
Figure 10.13 Track Measurement (before Horizontal Expansion)	180
Figure 10.14 Track Measurement (after Horizontal Expansion)	181
Figure 10.15 XY Mode	181
Figure 11.1 DVM Setting Menu	184
Figure 11.2 Frequency Counter Setting Menu	186
Figure 12.1 Eye Diagram Setting Menu	188
Figure 12.2 Eye Measurement Result	189
Figure 12.3 Diagram of Eye Measurement Parameters	192
Figure 13.1 Jitter Setting Menu	194
Figure 14.1 Reference Waveform Menu	198

Figure 14.2 Disk Management Interface	201
Figure 15.1 Pass/Fail Test Menu	203
Figure 16.1 Basic Setting Menu	207
Figure 16.2 Peak Search Menu	211
Figure 17.1 Schematic Diagram of Parallel Decoding	214
Figure 17.2 Parallel Decoding Menu	214
Figure 17.3 Parallel Decoding Event Table	217
Figure 17.4 Schematic Diagram of RS232 Serial Bus	218
Figure 17.5 Schematic Diagram of Negative Logic	218
Figure 17.6 RS232 Decoding Menu	219
Figure 17.7 RS232 Decoding Event Table	222
Figure 17.8 I2C Serial Bus	222
Figure 17.9 I2C Decoding Menu	223
Figure 17.10 I2C Decoding Event Table	225
Figure 17.11 SPI Serial Bus	226
Figure 17.12 SPI Decoding Menu	226
Figure 17.13 SPI Decoding Event Table	229
Figure 17.14 LIN Decoding Menu	230
Figure 17.15 LIN Decoding Event Table	232
Figure 17.16 CAN Decoding Menu	233
Figure 17.17 Sample Position	234
Figure 17.18 CAN Decoding Event Table	236
Figure 17.19 FlexRay Decoding Menu	237
Figure 17.20 Sample Position	238
Figure 17.21 FlexRay Decoding Event Table	239
Figure 17.22 I2S Decoding Menu	241
Figure 17.23 I2S Decoding Event Table	243
Figure 17.24 1553B Decoding Menu	244
Figure 17.25 1553B Decoding Event Table	246

Figure 18.1 USB2.0 Test Model	250
Figure 18.2 USB2.0 Signal Quality Compliance Analysis Test Result	255
Figure 18.3 Signal Type	257
Figure 18.4 100Base-T Signal Test Items	258
Figure 18.5 1000Base-T Signal Test Items	260
Figure 18.6 Typical Waveform of Test Mode 1 Signal	261
Figure 18.7 Configuration Menu	264
Figure 18.8 Connection Diagram	267
Figure 18.9 Fixture Calibration	268
Figure 18.10 LAN Compliance Analysis Test Report	271
Figure 19.1 "Add Window" Menu	272
Figure 20.1 Waveform Recording Interface	274
Figure 20.2 Play Operation Interface	277
Figure 21.1 Display Setting Menu	279
Figure 21.2 Vector Display	280
Figure 22.1 Image Saving Setting Menu	284
Figure 22.2 Waveform Saving Setting Menu	286
Figure 22.3 Setup Saving Setting Menu	288
Figure 22.4 Load Setting Menu	293
Figure 22.5 Upgrade Menu	294
Figure 22.6 Disk Management Interface	295
Figure 23.1 Self-calibration Menu	311
Figure 23.2 Quick Settings Menu	312
Figure 23.3 Key Test Interface	314
Figure 23.4 Touch Screen Test Interface	315
Figure 23.5 Touch-Enabled Gesture Operation Interface	316
Figure 23.6 Board Test Interface	317
Figure 24.1 Search for the Available Device	321
Figure 24.2 Confirm the Available Device	321

List of Tables

Table 5.1 BW Limit	47
Table 5.2 Probe Ratio	50
Table 8.1 Video Standard	83
Table 9.1 Window Function	149
Table 9.2 Logic Operation	153
Table 17.1 Bus Setting	215
Table 18.1 High-speed Signal Quality Compliance Test Item	251
Table 18.2 Full-speed Signal Quality Compliance Test Item	251
Table 18.3 Low-speed Signal Quality Compliance Test Item	252
Table 18.4 Signal Configuration	254
Table 18.5 Pass Conditions for the Test Items of the 100Base-T Signal Type ..	258
Table 18.6 Pass Conditions for Test Mode 1	261
Table 18.7 Pass Conditions for Test Mode 2	262
Table 18.8 Pass Conditions for Test Mode 3	263
Table 18.9 Pass Conditions for Test Mode 4	263
Table 22.1 BIN File Format	289
Table 22.2 File Header	289
Table 22.3 Waveform Header	290
Table 22.4 Waveform Data Header	292
Table 22.5 Factory Settings	297

1 Safety Requirement

1.1 General Safety Summary

Please review the following safety precautions carefully before putting the instrument into operation so as to avoid any personal injury or damage to the instrument and any product connected to it. To prevent potential hazards, please follow the instructions specified in this manual to use the instrument properly.

- **Use Proper Power Cord.**

Only the exclusive power cord designed for the instrument and authorized for use within the destination country could be used.

- **Ground the Instrument.**

The instrument is grounded through the Protective Earth lead of the power cord. To avoid electric shock, it is essential to connect the earth terminal of the power cord to the Protective Earth terminal before connecting any inputs or outputs.

- **Connect the Probe Correctly.**

If a probe is used, the probe ground lead must be connected to earth ground. Do not connect the ground lead to high voltage. Improper way of connection could result in dangerous voltages being present on the connectors, controls or other surfaces of the oscilloscope and probes, which will cause potential hazards for operators.

- **Observe All Terminal Ratings.**

To avoid fire or shock hazard, observe all ratings and markers on the instrument and check your manual for more information about ratings before connecting the instrument.

- **Use Proper Overvoltage Protection.**

Ensure that no overvoltage (such as that caused by a bolt of lightning) can reach the product. Otherwise, the operator might be exposed to the danger of an electric shock.

- **Do Not Operate Without Covers.**

Do not operate the instrument with covers or panels removed.

- **Do Not Insert Objects Into the Air Outlet.**

Do not insert objects into the air outlet, as doing so may cause damage to the instrument.

- **Use the Proper Fuse.**

Please use the specified fuses.

- **Avoid circuit or wire exposure.**

Do not touch exposed junctions and components when the instrument is powered on.
- **Do Not Operate With Suspected Failures.**

If you suspect damage occurs to the instrument, have it inspected by RIGOL authorized personnel before further operations. Any maintenance, adjustment or replacement especially to circuits or accessories must be performed by RIGOL authorized personnel.
- **Keep Well Ventilation.**

Inadequate ventilation may cause an increase of temperature in the instrument, which would cause damage to the instrument. So please keep the instrument well ventilated and inspect the air outlet and the fan regularly.
- **Do Not Operate in Wet Conditions.**

To avoid short circuit inside the instrument or electric shock, never operate the instrument in a humid environment.
- **Do Not Operate in an Explosive Atmosphere.**

To avoid personal injuries or damage to the instrument, never operate the instrument in an explosive atmosphere.
- **Keep Instrument Surfaces Clean and Dry.**

To avoid dust or moisture from affecting the performance of the instrument, keep the surfaces of the instrument clean and dry.
- **Prevent Electrostatic Impact.**

Operate the instrument in an electrostatic discharge protective environment to avoid damage induced by static discharges. Always ground both the internal and external conductors of cables to release static before making connections.
- **Use the Battery Properly.**

Do not expose the battery (if available) to high temperature or fire. Keep it out of the reach of children. Improper change of a battery (lithium battery) may cause an explosion. Use the RIGOL specified battery only.
- **Handle with Caution.**

Please handle with care during transportation to avoid damage to keys, knobs, interfaces, and other parts on the panels.

**WARNING**

Equipment meeting Class A requirements may not offer adequate protection to broadcast services within residential environment.

1.2 Safety Notices and Symbols

Safety Notices in this Manual:



WARNING

Indicates a potentially hazardous situation or practice which, if not avoided, will result in serious injury or death.



CAUTION

Indicates a potentially hazardous situation or practice which, if not avoided, could result in damage to the product or loss of important data.

Safety Notices on the Product:

- **DANGER**

It calls attention to an operation, if not correctly performed, could result in injury or hazard immediately.

- **WARNING**

It calls attention to an operation, if not correctly performed, could result in potential injury or hazard.

- **CAUTION**

It calls attention to an operation, if not correctly performed, could result in damage to the product or other devices connected to the product.

Safety Symbols on the Product:



Hazardous
Voltage



Safety Warning



Protective Earth
Terminal

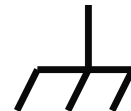

Chassis Ground



Test Ground

1.3 Measurement Category

Measurement Category

This instrument can make measurements in Measurement Category I.



WARNING

This instrument can only be used for measurements within its specified measurement categories.

Measurement Category Definitions

- **Measurement category I** is for measurements performed on circuits not directly connected to MAINS. Examples are measurements on circuits not derived from MAINS, and specially protected (internal) MAINS derived circuits. In the latter case, transient stresses are variable. Thus, you must know the transient withstand capability of the equipment.
- **Measurement category II** is for measurements performed on circuits directly connected to low voltage installation. Examples are measurements on household appliances, portable tools and similar equipment.
- **Measurement category III** is for measurements performed in the building installation. Examples are measurements on distribution boards, circuit-breakers, wiring (including cables, bus-bars, junction boxes, switches and socket-outlets) in the fixed installation, and equipment for industrial use and some other equipment. For example, stationary motors with permanent connection to a fixed installation.
- **Measurement category IV** is for measurements performed at the source of a low-voltage installation. Examples are electricity meters and measurements on primary overcurrent protection devices and ripple control units.

1.4 Ventilation Requirement

This instrument uses a fan to force cooling. Please make sure that the air inlet and outlet areas are free from obstructions and have free air. When using the instrument in a bench-top or rack setting, provide at least 10 cm clearance beside, above and behind the instrument for adequate ventilation.



CAUTION

Inadequate ventilation may cause an increase of temperature in the instrument, which would cause damage to the instrument. So please keep the instrument well ventilated and inspect the air outlet and the fan regularly.

1.5 Working Environment

Temperature

Operating: 0°C to +50°C

Non-operating: -30°C to +70°C

Humidity

- **Operating:**
 - Below +30°C: ≤90%RH (without condensation)
 - +30°C to +40°C: ≤75% RH (without condensation)

+40°C to +50°C: ≤45%RH (without condensation)

- **Non-operating:**

Below +65°C: ≤90%RH (without condensation)



WARNING

To avoid short circuit inside the instrument or electric shock, never operate the instrument in a humid environment.

Altitude

- **Operating:** below 3 km
- **Non-operating:** below 15 km

Protection Level Against Electric Shock

ESD ±8kV

Installation (Overvoltage) Category

This product is powered by mains conforming to installation (overvoltage) category II.



WARNING

Ensure that no overvoltage (such as that caused by a bolt of lightning) can reach the product. Otherwise, the operator might be exposed to the danger of an electric shock.

Installation (Overvoltage) Category Definitions

Installation (overvoltage) category I refers to signal level which is applicable to equipment measurement terminals connected to the source circuit. Among these terminals, precautions are done to limit the transient voltage to a low level.

Installation (overvoltage) category II refers to the local power distribution level which is applicable to equipment connected to the AC line (AC power).

Pollution Degree

Pollution Degree 2

Pollution Degree Definition

- **Pollution Degree 1:** No pollution or only dry, nonconductive pollution occurs. The pollution has no effect. For example, a clean room or air-conditioned office environment.
- **Pollution Degree 2:** Normally only nonconductive pollution occurs. Temporary conductivity caused by condensation is to be expected. For example, indoor environment.
- **Pollution Degree 3:** Conductive pollution or dry nonconductive pollution that becomes conductive due to condensation occurs. To be found in industrial

environment or construction sites (harsh environments). For example, sheltered outdoor environment.

- **Pollution Degree 4:** The pollution generates persistent conductivity caused by conductive dust, rain, or snow. For example, outdoor areas.

Safety Class

Class 1 – Grounded Product

1.6 Care and Cleaning

Care

Do not store or leave the instrument where it may be exposed to direct sunlight for long periods of time.

Cleaning

Clean the instrument regularly according to its operating conditions.

1. Disconnect the instrument from all power sources.
2. Clean the external surfaces of the instrument with a soft cloth dampened with mild detergent or water. Avoid having any water or other objects into the chassis via the heat dissipation hole. When cleaning the LCD, take care to avoid scarifying it.



CAUTION

To avoid damage to the instrument, do not expose it to caustic liquids.



WARNING

To avoid short-circuit resulting from moisture or personal injuries, ensure that the instrument is completely dry before connecting it to the power supply.

1.7 Environmental Considerations

The following symbol indicates that this product complies with the WEEE Directive 2002/96/EC.



The equipment may contain substances that could be harmful to the environment or human health. To avoid the release of such substances into the environment and avoid harm to human health, we recommend you to recycle this product appropriately to ensure that most materials are reused or recycled properly. Please contact your local authorities for disposal or recycling information.

You can click on the following link <https://int.rigol.com/services/services/declaration> to download the latest version of the RoHS&WEEE certification file.

1.8 Keep Hands Clear



WARNING

While the main screen is opening or closing, keep hands clear from the inclination angle between the main screen and its instrument body to avoid being pinched.

2 Product Features

Product Features

- Number of channels: 4 analog channels, 1 EXT channel
- Analog channel bandwidth: Max. 5 GHz
- Up to 20 GSa/s sample rate
- Max. 2 Gpts memory depth
- Waveform capture rate: > 1,000,000 wfms/s
- Vertical sensitivity range: 1 mV/div~10 V/div (1 M Ω), 1 mV/div~1 V/div (50 Ω)
- Timebase range: 50 ps/div~1000 s/div
- Up to 2,000,000 frames of hardware real-time and ceaseless waveforms recording and playback functions
- Integrates 5 independent instruments into 1, including digital oscilloscope, spectrum analyzer (option), digital voltmeter, 8-digit frequency counter and totalizer, and protocol analyzer (option)
- Standard trigger functions: Edge trigger, Pulse trigger, Slope trigger, Video trigger, Pattern trigger, Duration trigger, Timeout trigger, Runt trigger, Window trigger, Delay trigger, Setup/Hold trigger, Nth Edge trigger, RS232, I2C, SPI, CAN, FlexRay, LIN, I2S, and MIL-STD-1553
- A variety of serial decoding functions (option): RS232, I2C, SPI, CAN, FlexRay, LIN, I2S, MIL-STD-1553, and CAN-FD; supporting 4 decoding channels
- Auto measurement of 41 waveform parameters; full-memory hardware measurement function
- A variety of math operations: A+B, A-B, A \times B, A/B, FFT, A&&B, A||B, A^B, !A, Intg, Diff, Lg, Ln, Exp, Sqrt, Abs, AX+B, LowPass, HighPass, BandPass, BandStop, built-in FFT analysis and peak search function
- Real-time eye diagram and jitter analysis (option)
- Unique UltraVision III technical platform
- Multiple interfaces available: USB HOST&DEVICE, LAN(LXI), HDMI, AUX OUT; Web Control supported
- Main 15.6" HD capacitive multi-touch screen with one-button electronic tilt; multi-pane windowing
- The photoelectric encoder operating knob prolongs its service life, guaranteeing more than 100,000 times of pressing operation and 1 million times of rotation operation, greatly improving its service life
- Secondary 3.5-inch touch screen separates menus and functions from signals and analysis with a customized function and shortcut menu
- Electronic label display of the model and main parameters of the product, capable to be updated when any option is upgraded, sustaining the display contents up to 20 years

Product Features

- Support online version upgrade
- 7 GHz active differential probe PVA8700 (option)

DS70000 series digital oscilloscope adopts RIGOL's chipset "Phoenix", delivering excellent performance with the maximum sample rate of 20 GSa/s, 5 GHz bandwidth. RIGOL's brand new UltraVison III technical platform guarantees the specifications to reach the advanced level in the industry, with the capture rate up to 1,000,000 wfms/s, 2 Gpts memory depth, and 8 bits ~ 16 bits adjustable resolution. In addition to the improved hardware specifications, the DS70000 series digital oscilloscope has a main 15.6-inch HD capacitive multi-touch screen with one-button electronic tilt for signal visualization, analysis, and results. Meanwhile, the secondary 3.5-inch touch screen separates menus and functions from signals and analysis with a customized function and shortcut menu. These user-friendly designs brings users an extraordinary human-machine interface experience.

3 Document Overview

This manual gives you a quick review about the front and rear panel of DS70000 series, the user interface, and the basic operation method.



TIP

For the latest version of this manual, download it from the official website of RIGOL (<http://www.rigol.com>).

Publication Number

UGA29102-1110

Software Version

Software upgrade might change or add product features. Please acquire the latest version of the manual from RIGOL website or contact RIGOL to upgrade the software.

Format Conventions in this Manual

1. Key

The front panel key is denoted by the menu key icon. For example,



indicates the "Default" key.

2. Menu

The menu item is denoted by the format of "Menu Name (Bold) + Character Shading" in the manual. For example, **Setup** indicates clicking or tapping the "Setup" sub-menu under the "Utility" function menu to view the basic setting configuration items.





3. Operation Procedures



The next step of the operation is denoted by ">" in the manual. For example,



> **Storage** indicates that first clicking or tapping the icon , then clicking or tapping **Storage**.

4. Knob

Label	Knob	Label	Knob
 Channel	Channel On/Off Button	 Multifunction	Multi-function Button
 Multifunction	Multi-function Knob	 Multifunction	Multi-function Knob

Label	Knob	Label	Knob
 <u>SCALE</u>	Channel Vertical Scale Knob	 <u>OFFSET</u>	Channel Vertical Position Knob

Content Conventions in this Manual

DS70000 series digital oscilloscope includes the following models. Unless otherwise specified, this manual takes DS70504 as an example to illustrate the functions and operation methods of DS70000 series.

Model	Max. Analog Bandwidth	No. of Analog Channels
DS70504	5 GHz	4
DS70304	3 GHz	4

4 Quick Start

4.1 General Inspection

1. Inspect the packaging

If the packaging has been damaged, do not dispose the damaged packaging or cushioning materials until the shipment has been checked for completeness and has passed both electrical and mechanical tests.

The consigner or carrier shall be liable for the damage to the instrument resulting from shipment. RIGOL would not be responsible for free maintenance/rework or replacement of the instrument.

2. Inspect the instrument

In case of any mechanical damage, missing parts, or failure in passing the electrical and mechanical tests, contact your RIGOL sales representative.

3. Check the accessories

Please check the accessories according to the packing lists. If the accessories are damaged or incomplete, please contact your RIGOL sales representative.

Recommended Calibration Interval

RIGOL suggests that the instrument should be calibrated every 18 months.

4.2 Appearance and Dimensions

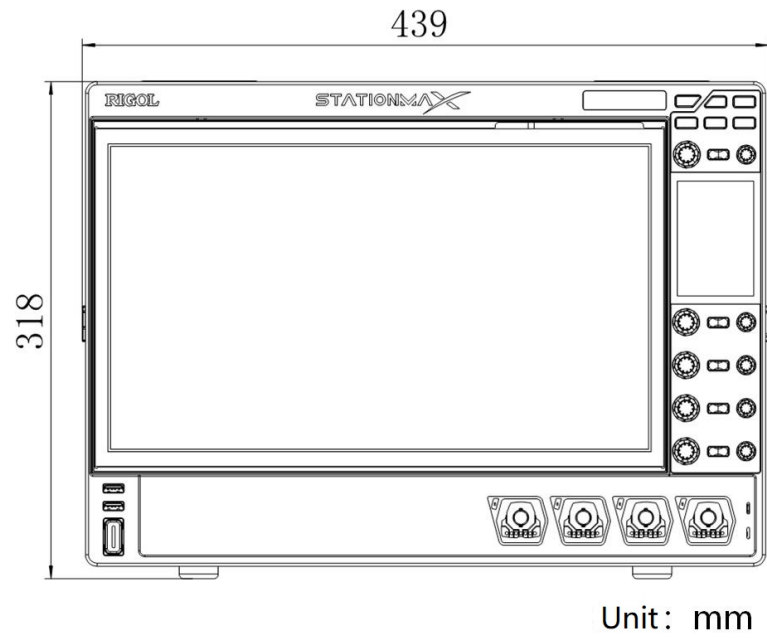

Figure 4.1 Front View

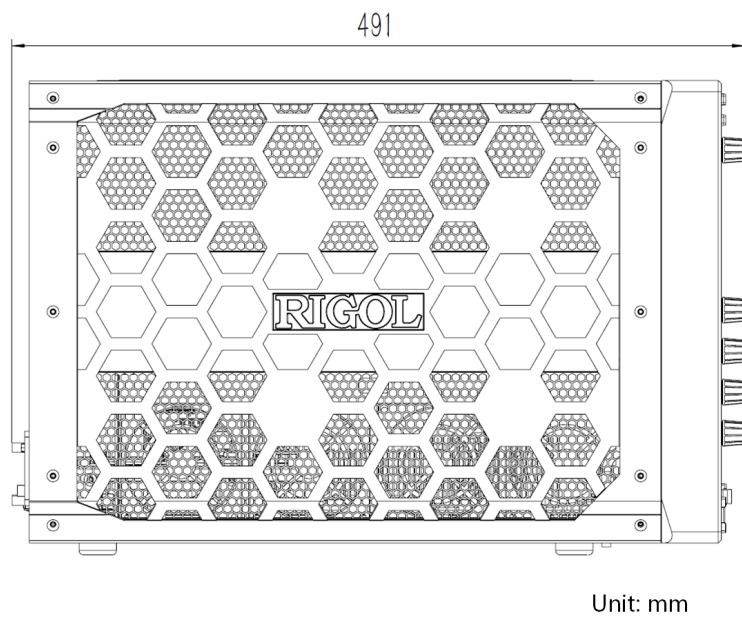

Figure 4.2 Side View

4.3 To Prepare for Use

4.3.1 To Connect to AC Power

The power requirements of the oscilloscope are 100-240 V, 45-440 Hz. Please use the power cord provided in the accessories to connect the oscilloscope to the AC power source, as shown in *Figure 4.3*.

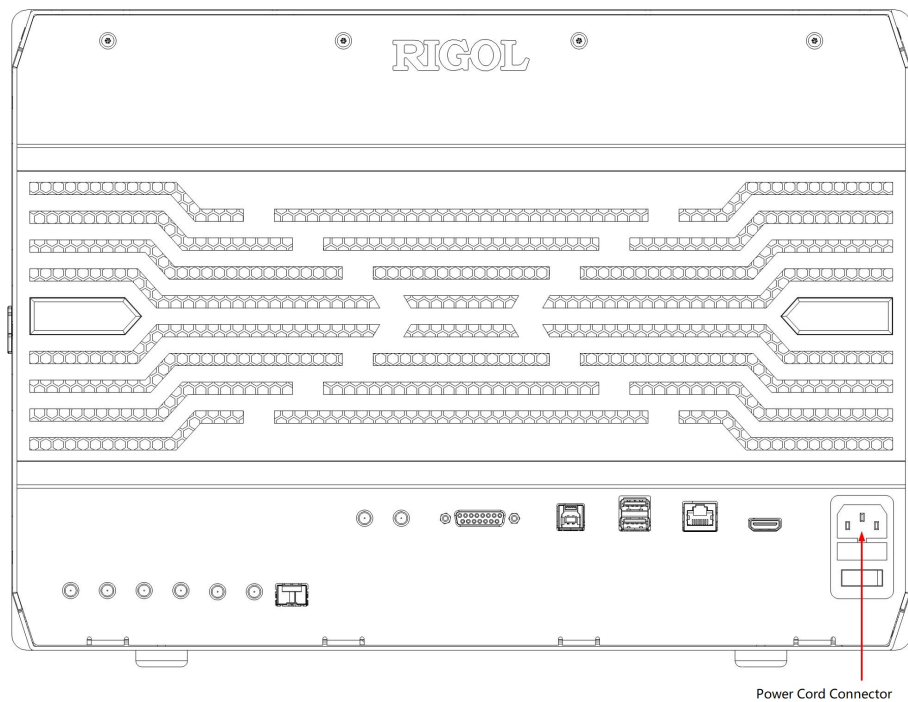



Figure 4.3 To Connect to AC Power





WARNING

To avoid electric shock, ensure that the instrument is correctly grounded.

4.3.2 Turn-on Checkout

After the instrument is connected to the power source, press the power key  at the lower-left corner of the front panel to power on the instrument. During the start-up process, the instrument performs a series of self-tests. After the self-test, the splash screen is displayed.

- **Restart:** Click or tap the function navigation icon  at the lower-left corner of the screen to open the function navigation. Click or tap the **Restart** icon, then a prompt message "Are you sure to reboot?" is displayed. Click or tap **OK** to restart the instrument.

- **Shutdown:** Click or tap the function navigation icon  at the lower-left corner of the screen to open the function navigation. Click or tap the **Shutdown** icon, then a prompt message "Are you sure to shutdown?" is displayed. Click or tap **OK** to shut down the instrument. You can also press the Power key at the lower-left corner of the instrument to turn off the instrument.

4.3.3 To Set the System Language

This instrument supports multiple languages. You can click or tap  > **Utility** > **Setup** > **Language** to set the system language.

4.3.4 To Connect the Probe

RIGOL provides the passive and active probes for the DS70000 series. For specific probe models, please refer to *DS70000 Data Sheet*. For detailed technical information of the probes, please refer to the corresponding Probe User Guide.

Connect the Passive Probe

1. Connect the BNC terminal of the probe to an analog channel input terminal of the oscilloscope on the front panel as shown in *Figure 4.4*.
2. Connect the ground alligator clip or spring of the probe to the circuit ground terminal, and then connect the probe tip to the circuit point to be tested.

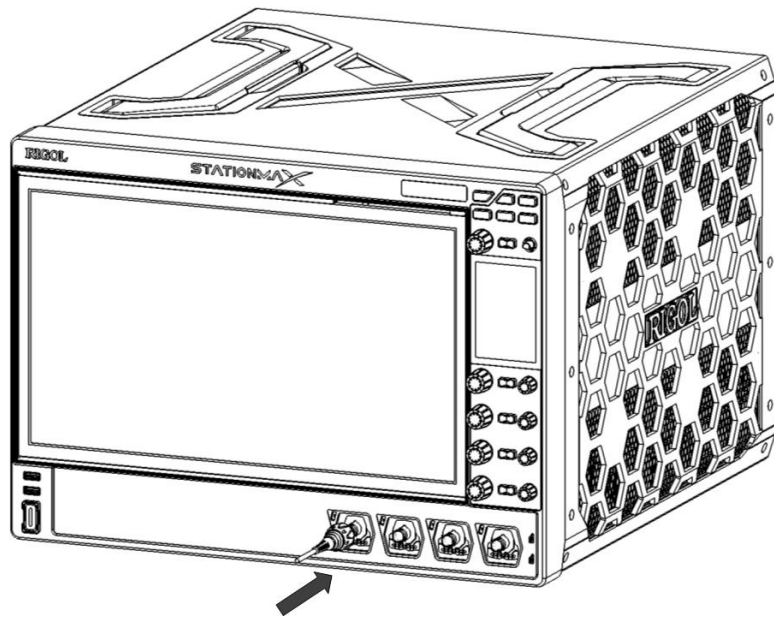

Figure 4.4 Connect the Passive Probe

After you connect the passive probe, check the probe function and probe compensation adjustment before making measurements. For detailed procedures, refer to *Function Inspection* and *Probe Compensation*.

Connect the Active Probe

Take PVA8000 (active differential probe) as an example.

1. Connect the probe head to the preamp of the active probe, as shown in the figure below.

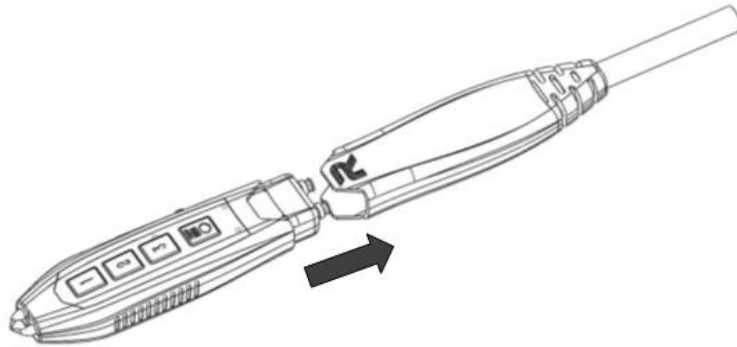

Figure 4.5 To Connect the Probe Head to the PA of the Active Probe

2. Connect the other end of the preamp to an analog channel input terminal of the oscilloscope on the front panel, as shown in the figure below. Note that you need to push the probe to the due position to lock it firmly.

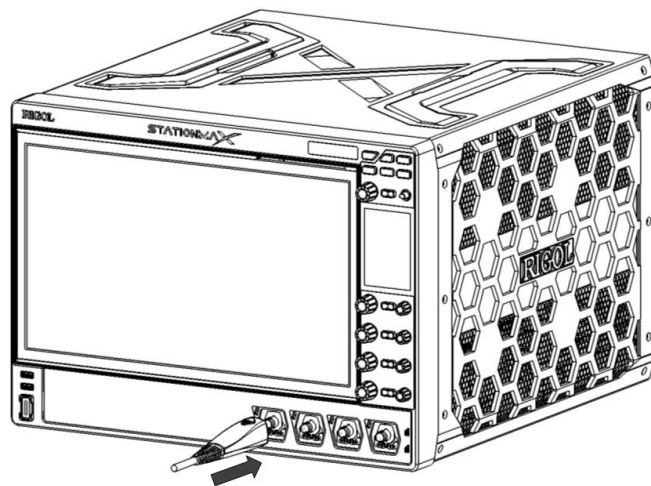

Figure 4.6 Connect the Active Probe

3. Use the probe's auxiliary device to connect the probe head to the circuit under test. For detailed information of the probes, please refer to *User Guide for PVA8000 Series Active Probe*.

After connecting the active probe, you can perform probe calibration and offset voltage adjustment if necessary. For detailed procedures, refer to descriptions about the active probe in User Guide.

4.3.5 Function Inspection

1. Press **Default** on the front panel, then a prompt message displaying "Restore default settings?" appears on the screen. Click **OK** to restore the instrument to its factory default settings.
2. Connect the ground alligator clip of the probe to the "Ground Terminal" as shown in *Figure 4.7* below.
3. Use the probe to connect the input terminal of CH1 of the oscilloscope and the "Compensation Signal Output Terminal" of the probe, as shown in *Figure 4.7*.

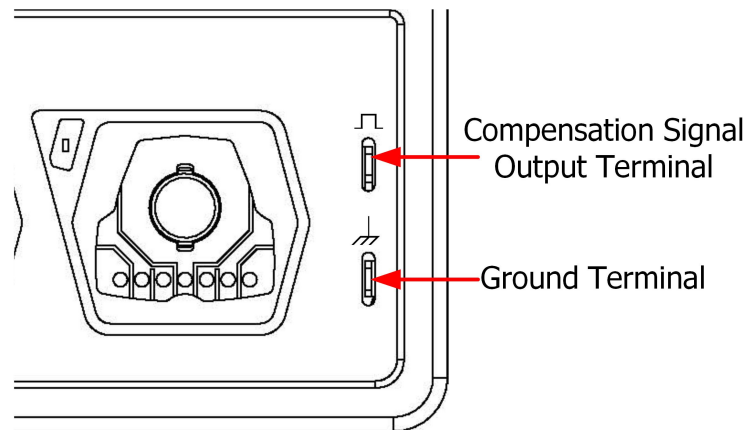



Figure 4.7 To Use the Compensation Signal

4. Set the probe ratio based on the attenuation of the probe, and then click  **>**
Auto.
5. Observe the waveform on the display. In normal condition, the square waveform as shown in the figure below should be displayed.

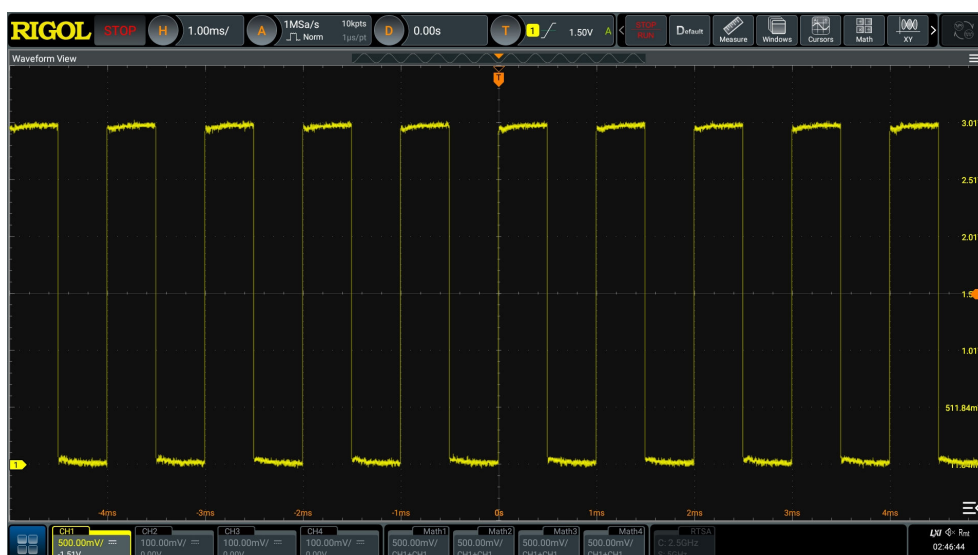

Figure 4.8 Waveform Signal

6. Use the same method to test the other channels. If the square waveforms actually shown do not match that in the figure above, please perform "**Probe Compensation**" introduced in the next section.



WARNING

To avoid electric shock when using the probe, please make sure that the insulated wire of the probe is in good condition. Do not touch the metallic part of the probe when the probe is connected to high voltage source.

4.3.6 Probe Compensation

When the probes are used for the first time, you should compensate the probes to make them match the input channels of the oscilloscope. Non-compensated or poorly compensated probes may cause measurement inaccuracy or errors. The probe compensation procedures are as follows:

1. Perform Step 1, 2, 3 and 4 in *Function Inspection*.
2. Check the displayed waveforms and compare them with the waveforms shown in

Figure 4.9.

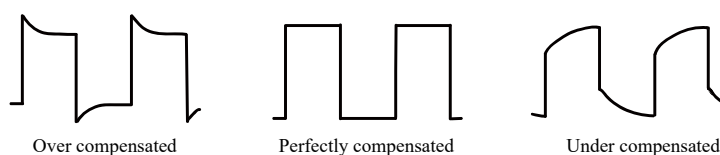

Figure 4.9 Probe Compensation

- Use the probe compensation adjustment tool provided in the accessories to adjust the low-frequency compensation adjustment hole on the probe until the displayed waveform is consistent with the "Perfectly compensated" waveform shown in the above figure.

4.4 Product Overview

This chapter introduces the front/rear panel of the oscilloscope and its user interface.

4.4.1 Front Panel Overview

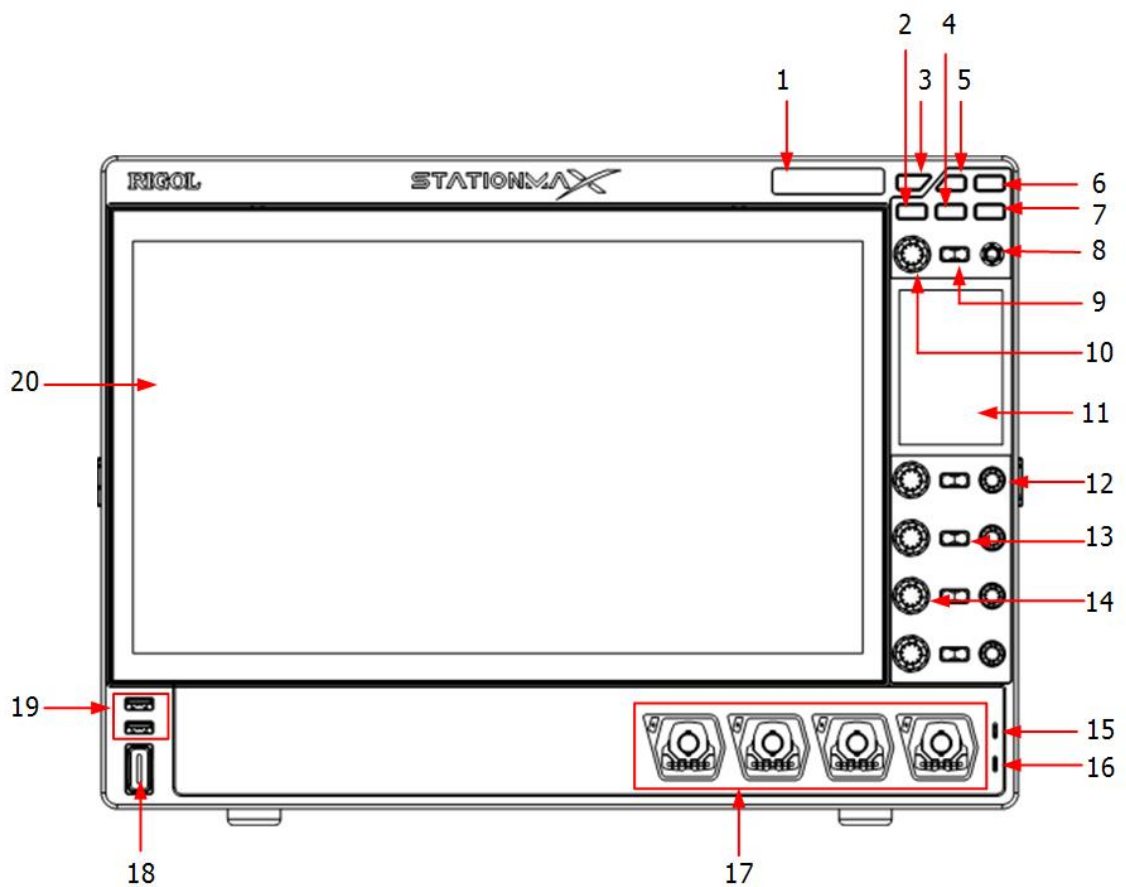

Figure 4.10 Front Panel

1. Electronic Label

The product model and its main parameters displayed on the electronic label, sustaining its contents up to 20 years even at power-off state. The parameters will be updated automatically after upgrade to keep the information displayed on the electronic label consistent with that of the current instrument.

2. Screen Tilt Adjustment Key

Controls whether to adjust the tilt of the large and high-definition 15.6-inch touch screen.

3. Run/Stop Key

Controls the operating status of the channel output signal.

4. Default

Press this key to restore the instrument to its default settings.

5. Working Mode Switchover Key

Press this key to switch between DSO and AWG modes.

6. Quick Operation Key

Related to quick operation setting. It is used to customize the quick operation key for a specified function. By default, it's a shortcut key for screen capture.

7. Key

Temporarily unavailable to use.

8. Multifunction Knob

Its function corresponds with the function key currently selected on the secondary high-definition smart and quick-responsive touch screen. By default, it is used to adjust the horizontal position.

9. Multifunction Key

Its function corresponds with the function key currently selected on the secondary high-definition smart and quick-responsive touch screen. By default, it is used to enable or disable the horizontal setting menu.

10. Multifunction Knob

Its function corresponds with the function key currently selected on the secondary high-definition smart and quick-responsive touch screen. By default, it is used to adjust the horizontal time base.

11. High-Definition Smart and Quick-responsive Shortcut Menu Display

By default, users can operate the instrument with the functions icons available on the small screen. When you press the tilt adjustment key, you can adjust the tilt of the main display on this screen.

12. Channel Vertical Offset Knob

Adjusts the vertical offset of the channel.

13. Channel On/Off Button

Pressing this button continuously can enable or disable the specified analog input channel.

14. Channel Vertical Scale Knob

Adjusts the vertical scale of the channel.

15. Probe Compensation Signal Output Terminal

16. Probe Compensation Signal Ground Terminal

17. Analog Channel Input Terminals

Can be connected to the probe and inputs the analog signal.

18. Power Key

Powers on or off the instrument.

19. USB HOST Interface

Supports FAT32 format Flash type USB storage device, and the USB-GPIB interface converter.

- **USB storage device:** reads the waveform or sequence files saved in the USB storage device; stores the edited waveform and sequence data into the USB storage device; saves the contents displayed on the screen to the USB storage device in the format of a captured image.
- **USB-GPIB interface converter (standard accessory):** extends the GPIB interface for RIGOL instruments that integrates the USB HOST interface but not the GPIB interface.

20. High-Definition Large Touch Screen with One Button Electronic Tilt

The tilt of the 15.6-inch high-definition large touch screen can be electronically adjusted with one button. Displays the menu label and parameter settings of the current function, system state, prompt messages, and other information.

4.4.2 Rear Panel Overview

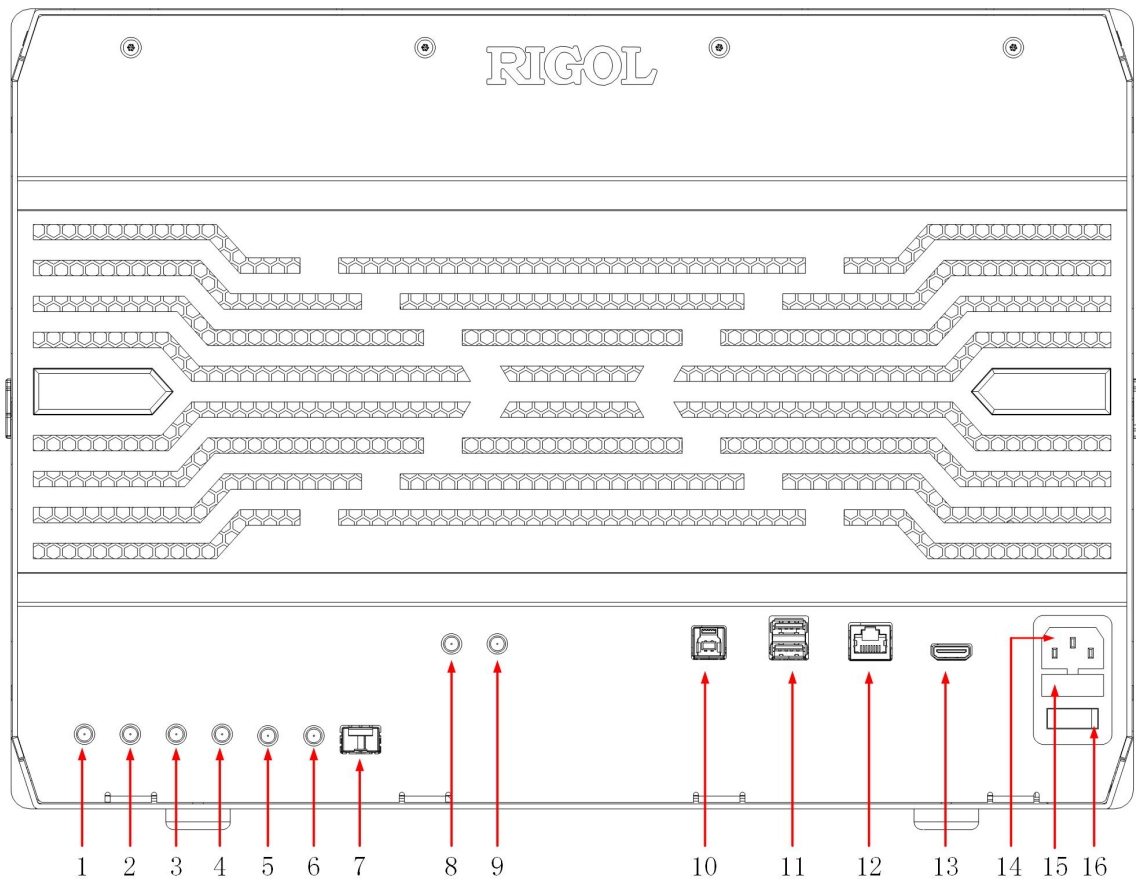

Figure 4.11 Rear Panel

1. **Pulse Source Input**
(temporarily unavailable)
2. **Pulse Source Output**
(temporarily unavailable)
3. **Pulse Source Reverse Output**
(temporarily unavailable)
4. **Pulse Source Reverse Input**
(temporarily unavailable)
5. **AUX OUT**
 - **Trig Out:**

The oscilloscope can output a signal that can reflect the current capture rate of the oscilloscope at each trigger via this SMA connector interface. Connect the

signal to a waveform display device and measure the frequency of the signal. The measurement result is the same as the current capture rate.

- **Pass/Fail:**

In the pass/fail test, the instrument will output a pulse via the SMA connector when a passed or failed waveform is detected during the pass/fail test.

6. EXT 1MΩ//18pF

Inputs the external trigger signal.

7. SFP+ Interface

(temporarily unavailable)

8. 10 MHz OUT

An SMA connector that can output the 10 MHz clock signal generated by the internal crystal oscillator inside the instrument.

9. 10 MHz IN

An SMA connector that can input the external reference clock signal.

10. USB DEVICE

Connects the instrument to the PC via this interface. Then you can use the PC software Ultra Scope to send the SCPI commands or use the user-defined programming to control the instrument.

11. USB HOST Interface

Connects the compatible storage device to the instrument, supporting FAT32 format Flash type USB storage device and the USB-GPIB interface converter.

- **USB storage device:** reads the waveform files or state files saved in the USB storage device; or stores the current instrument states or edited waveform data into the USB storage device; saves the contents displayed on the screen to the USB storage device in the format of a captured image.
- **USB-GPIB interface converter (optional accessory):** extends the GPIB interface for RIGOL instruments that integrates the USB HOST interface but not the GPIB interface.

12. LAN:

Connects the instrument to network via this interface. The instrument is in compliance with the standards specified in LXI Device Specification 2011. It can be used to set up a test system with other standard devices. Then you can use the Web Control to send the SCPI commands to control the instrument. When update is available, you can perform online upgrading for the system software of the instrument via the LAN interface.

13. HDMI

You can connect the instrument to an external display that has the HDMI interface (e.g. monitor or projector) via this interface to better observe the waveform display clearly. At this time, you can also view the waveforms on the LCD of the instrument.

14. AC Power Cord Connector

The rated AC power source supported by the instrument is 100-240 V, 45-440 Hz. The maximum input power shall not exceed 500 W. Please use the power cord provided in the accessories to connect the instrument to the AC power source.

15. Fuse

If you need to replace the fuse, use only the specified fuse.

16. Power Switch

4.4.3 User Interface

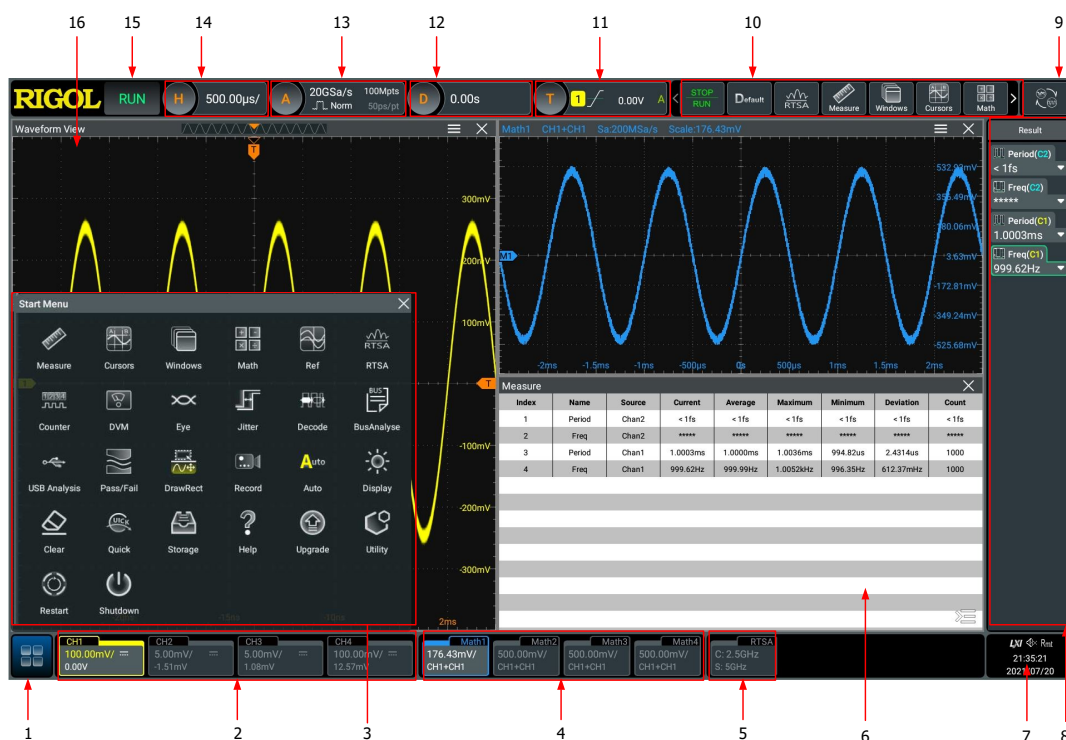

Figure 4.12 User Interface

1. Function Navigation Icon

Tap this icon to open the function navigation menu.

2. Channel Label

- Displays the on/off status of CH1~CH4 respectively.

- Displays the coupling mode of the channel.
- Displays the vertical scale of the channel.
- Displays the vertical offset of the channel.

3. Function Navigation Menu

In this menu, tap the specified function icon to enter the desired function menu to make configurations.

4. Channel Operation Label

Displays the on/off status of the operation channel Math1~Math4, its operation type, and vertical scale.

5. RTSA Label





Displays the status of RTSA mode.

6. Multi-window Display Area

If you enable multi-window display, then multiple windows can be displayed on the screen at one time.

7. Notification Area

Displays the sound icon, USB icon, time, and LAN icon.

- USB storage device icon: When a USB storage device is detected,  will be displayed.
- LAN connection icon: When the LAN interface is successfully connected,  is displayed.
- Sound icon: In the "Utility" menu, click or tap **Setup** > **Beeper** to enable or disable the sound. When on,  will be displayed; when off,  will be displayed.
- Remote control icon: When you control the instrument remotely,  will be displayed.
- Time: displays the system time. For the setting of the system time, refer to descriptions in *Display Time*.

8. Result Display Window

Displays the measurement results and statistics of various functions. Click or tap

the icon  at the lower-right corner of the screen to open or close the statistics result display window.

9. Mode Switchover Icon

Temporarily unavailable.

10. Function Icon Bar

Lists some of the function icons available in the navigation menu, easy for you to perform quick operation for some functions.

11. Trigger Information Label

- Displays the trigger information of the system, including the trigger type, trigger level, trigger mode, and etc.
- Click or tap the trigger information label, then the trigger setting window is displayed. You can set the parameters for the trigger.

12. Horizontal Position Label

Displays the current horizontal position. Click or tap this label to enter the horizontal setting menu.

13. Sample Rate and Memory Depth Label

Displays the current sample rate and memory depth. Click or tap this label to enter the horizontal setting menu.



14. Horizontal Time Base Label

Displays the current horizontal time base. Click or tap this label to enter the horizontal setting menu.

15. Operating Status

Displays the operating status of the instrument.

16. Waveform Display Area

Displays the measurement waveform window for CH1-CH4. Click or tap  at the upper-right corner of the window to close the window. Click or tap  to enter the configuration menu of the specified function.

4.4.4 Secondary 3.5-inch Touch Screen

The 3.5-inch small screen at the right side of the front panel is called a secondary touch screen. The secondary touch screen separates menus and functions from signals and analysis with a customized function and shortcut menu. You can adjust the inclination of the main display.

Smart Quick-Responsive Shortcut Key Menu Display

The touch-enabled operation of DS70000 series oscilloscope can be operated on both the main and secondary touch screens.



Figure 4.13 Smart Quick-Responsive Shortcut Key Menu Display

1.  **Multifunction Knob Operation Icon**

The icon under the multifunction knob shows the current function of the knob. The icon changes with the selected quick shortcut key. You can use the multifunction knob above the icon to perform the specified function operation.

Let's take an example by illustrating the knob operation in [Figure 4.13](#). In the current interface, rotating this knob can adjust the horizontal time base of the oscilloscope; pressing down the knob can switch between the fine adjustment and coarse adjustment for the horizontal time base.

2.  **Multifunction Knob Operation Icon**

The icon under the multifunction knob shows the current function of the knob. The icon changes with the selected quick shortcut key. You can use the multifunction knob above the icon to perform the specified function operation.

Let's take an example by illustrating the knob operation in [Figure 4.13](#). In the current interface, pressing down the knob can open or close the horizontal menu.

3.  **Multifunction Knob Operation Icon**

The icon under the multifunction knob shows the current function of the knob. The icon changes with the selected quick shortcut key. You can use the multifunction knob above the icon to perform the specified function operation.

Let's take an example by illustrating the knob operation in *Figure 4.13*. In the current interface, rotating this knob can adjust the horizontal position of the oscilloscope; pressing down the knob can set the horizontal position to zero.

4. **SCALE Knob Operation Icon**

The icon above the SCALE knob shows function of the knob. The knob below the icon is used to adjust the vertical scale of the four channels. Rotating the knob for the specified channel can adjust the vertical scale of the channel; pressing down the knob can switch between the fine adjustment and coarse adjustment for the vertical scale.

5. **OFFSET Knob Operation Icon**

The icon above the SCALE knob shows function of the knob. The knob below the icon is used to adjust the vertical offset of the four channels. Rotating the knob for the specified channel can adjust the vertical offset of the channel; pressing down the knob can set the vertical offset to zero.

6. Quick-Responsive Shortcut Key Menu Display

Tap the quick shortcut key on the secondary touch screen to enter the specified function menu or enable the specified function. There are two menu pages and you can tap left and right to switch between the menu pages.

Flip Screen Adjustment Interface

The main display of the DS70000 series oscilloscope can be adjusted with one-button electric tilt. You can tilt the main display on the secondary touch screen. Press the

button  at the upper-right corner of the front panel to enter the tilt adjustment menu interface for the main display, as shown in *Figure 4.14*. Press the

button  again to go back to the quick-responsive shortcut key menu display.

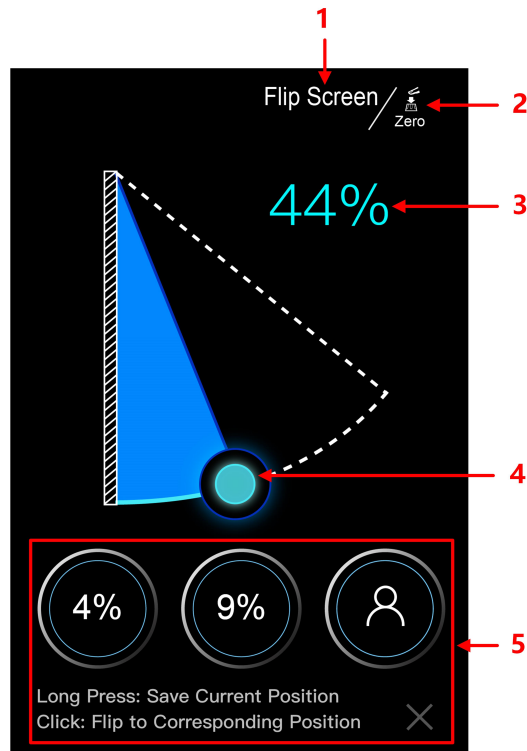



Figure 4.14 Flip Screen Adjustment Interface

1. Current Interface Operation

"Flip Screen" indicates that in the current interface, you can tilt the main display of the oscilloscope.

2. Multifunction Knob Function Icon

Above the icon is the  **Multifunction** knob. The icon shows the function of this knob. Pressing down this knob can reset the tilt of the main display to zero; rotating the knob can adjust the tilt.

3. Flip Screen Angle Percentage

Indicates the tilt percentage of the main display to the max. tilt available for the main display.

4. Tilt Adjustment

Tap to drag the icon to adjust the tilt of the main display.

5. Saved Tilt Angle

This oscilloscope supports users to save three commonly used tilt angle values for the main display. The instructions below show how to adjust the tilt of the main display.

- a. Drag the "Tilt Adjustment" icon to adjust the main display to a required tilt angle.
- b. Long press the "Saved Tilt Angle" icon to save the current tilt angle of the main display. After completing setting a tilt angle for the main display, the tilt percentage value will be shown on the icon.
- c. For future use, you just need to tap the icon with a specified tilt angle on it to make the main display to reach the specified tilt.

**CAUTION**

During adjusting the tilt of the main display, keep hands clear of the flip screen to avoid being pinched.

4.5 Touch Screen Gestures

The instrument provides a super large capacitive touch screen, which is convenient for users to operate and make configurations. It has strong waveform display capability and excellent user experience. It features great convenience, high flexibility, and great sensitivity. The actions supported by the touch screen controls include tapping, pinching&stretching, as well as dragging.

4.5.1 Tap

Use one finger to tap the symbol or characters on the screen slightly, as shown in *Figure 4.15*. With the Tap gesture, you can perform the following operations:

- Tap the menu displayed on the screen to operate on the menu.
- Tap the function navigation icon at the lower-left corner of the touch screen to enable the function navigation.
- Tap the displayed numeric keypad to set the parameters.
- Tap the virtual keypad to set the filename.
- Tap the close button at the upper-right corner of the message box to close the prompt window.
- Tap other windows on the touch screen and operate on the windows.



Figure 4.15 Tap Gesture

4.5.2 Pinch&Stretch

Pinch or stretch two points on the screen with two fingers to zoom in or out the waveform. To zoom in the waveform, first pinch the two fingers and then stretch the fingers; to zoom out the waveform, first stretch the two fingers, and then pinch the fingers together, as shown in the figure below. With the pinch&stretch gesture, you can perform the following operation:

- Pinching&stretching in the horizontal direction can adjust the horizontal time base of the waveform.
- Pinching&stretching in the vertical direction can adjust the vertical scale of the waveform.



Figure 4.16 Pinch&Stretch Gesture

4.5.3 Drag

Use one finger to select the object, and then drag the object to a destination place, as shown in [Figure 4.17](#). With the drag gesture, you can perform the following operation:

- Drag the waveform to change its position or scale.

- Drag the window controls to change the position of the window (e.g. numeric keypad).
- Drag the cursor to change the position of the cursor.
- In multi-window display, drag one of the displayed windows to change its position on the screen.

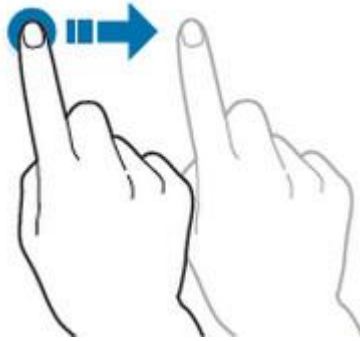

Figure 4.17 Drag Gesture

4.6 Parameter Setting Method

For this instrument, you can use the knob and touch screen to set parameters. The common parameter setting methods are as follows:

- **Method 1:** Some parameters can be adjusted by rotating the knob on the front panel.
- **Method 2:** Click or tap the input field of a specified parameter, then a virtual keypad is displayed. Complete the parameter setting with the keypad.

Input Chinese and English Characters

When naming a label, this instrument supports Chinese/English input method. The following part introduces how to input Chinese and English characters with the Chinese/English input method.

- **Input English Characters**

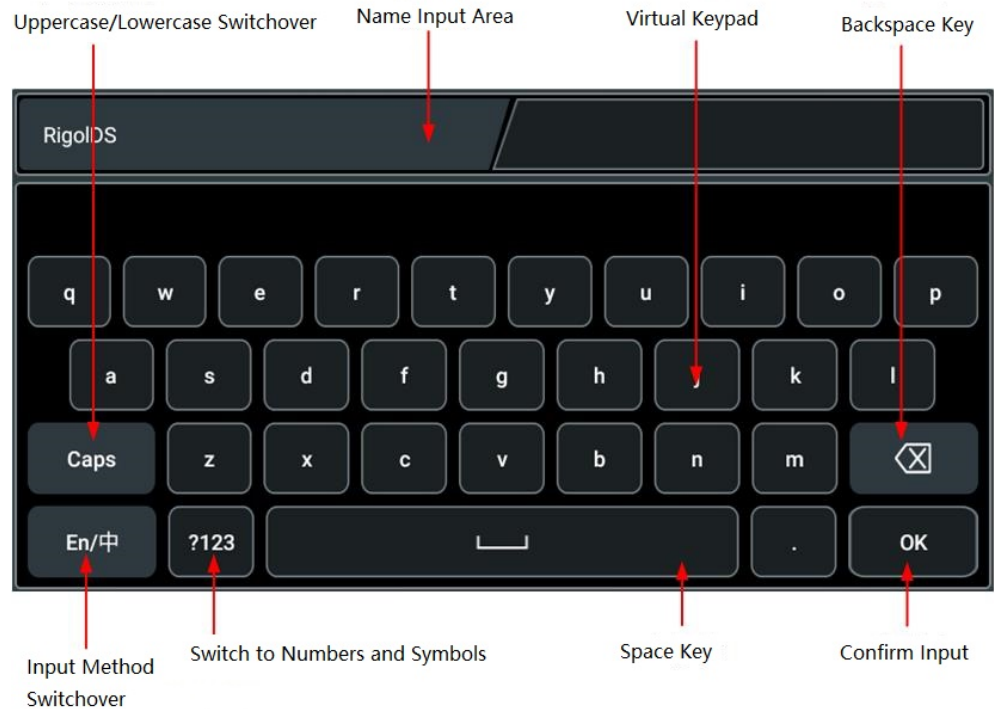

Figure 4.18 English Input Interface

1. Select English input method

First check the input method type. If it shows "En/中", then go to Step 2; if it shows "中/En", click or tap the input method switchover key to switch to "En/中" (English input method).

2. Clear the name input area

If there is no character in the "Name Input Area", please go to the next step. If there are characters in the "Name Input Area", click or tap the Backspace key to delete all the characters from the "Name Input Area" in order.

3. Input the upper-case letter

If you want to input an upper-case letter, first use the Caps key to switch between the upper-case and lower-case mode. If the Caps key is selected, input the upper-case letter with the virtual keypad. If not, first click or tap the Caps key to ensure it is selected, then input the upper-case letter. All the input letters will be displayed in the "Name Input Area".

4. Input the lower-case letter

Refer to the operation specified in the previous step. If the Caps key is not selected, directly input the lower-case letter.

5. Input numbers or symbols

If the letter keypad is displayed, you need to click or tap the numeric switchover key to switch to the numeric keypad, and input numbers or

symbols with the numeric keypad. All the input letters will be displayed in the "Name Input Area".

6. Modify or delete the unwanted characters that have been input

During the name input process, you can modify or delete the unwanted character if necessary. To delete the characters that have been input, click or tap the Backspace key in the virtual keypad to delete the characters. To modify the characters that have been input, delete the unwanted characters first and then input the new characters.

You can directly move the cursor to the character to be modified or deleted, delete the desired character or input the new characters after deleting the unwanted character.

7. Confirm the input

After completing the input operation, click or tap "OK".

- **Input Chinese Characters**



Figure 4.19 Chinese Input Interface

1. Select Chinese input method

First check the input method type. If it shows "中/En", then go to Step 2; if it shows "En/中", click or tap the input method switchover key to switch to "中/En" (Chinese input method).

2. Clear the name input area

If there is no character in the "Name Input Area", please go to the next step. If there are characters in the "Name Input Area", click or tap the Backspace key to delete all the characters from the "Name Input Area" in order.

If there are characters in the "Pinyin Input Area", when you delete characters from the name input area, the characters in the Pinyin input area will be deleted first.

3. Input Chinese characters

Click or tap the characters in the virtual keypad to input Pinyin into the input area, then the characters to be selected will be displayed in the Chinese character selection area. Slide to view more Chinese characters for you to choose. Select the desired Chinese character, and then the selected character will be displayed in the input area.

4. Modify or delete the unwanted characters that have been input

During the name input process, you can modify or delete the unwanted character if necessary. To delete the characters that have been input, click or tap the Backspace key in the virtual keypad to delete the characters. To modify the characters that have been input, delete the unwanted characters first and then input the new characters.

5. Confirm the input

After completing the input operation, click or tap "OK".

Input a String

When naming a file or folder, you need to input a string with the keypad shown in *Figure 4.20*.

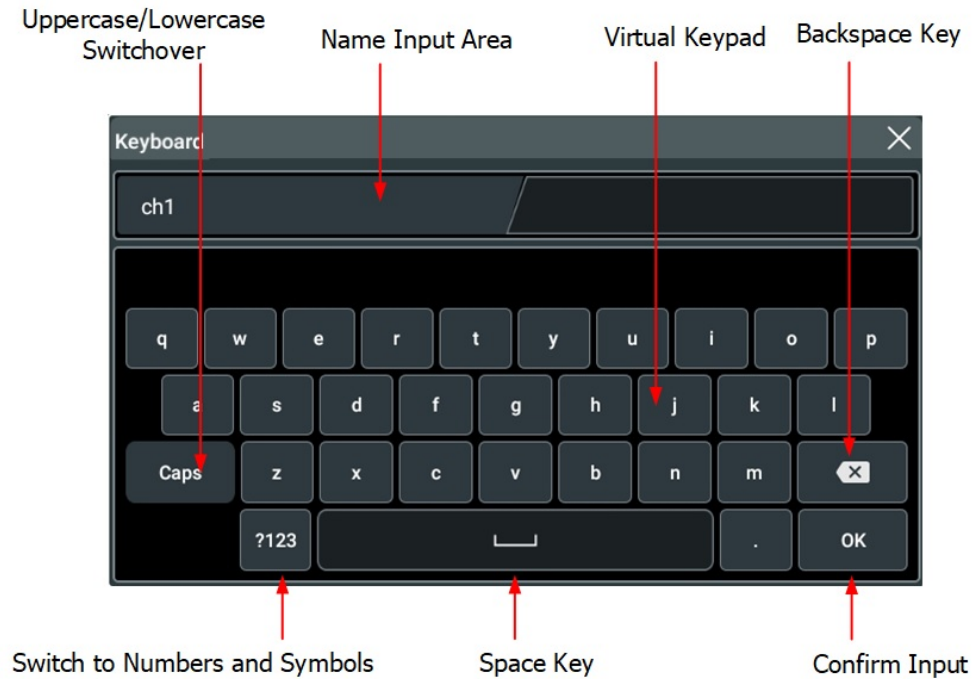

Figure 4.20 String Keypad

1. Clear the name input area

If there is no character in the "Name Input Area", please go to the next step. If there are characters in the "Name Input Area", click or tap the Backspace key to delete all the characters from the "Name Input Area" in order.

2. Input the upper-case letter

If you want to input an upper-case letter, first use the Caps key to switch between the upper-case and lower-case mode. If the Caps key is selected, input the upper-case letter with the virtual keypad. If not, first click or tap the Caps key to ensure it is selected, then input the upper-case letter. All the input letters will be displayed in the "Name Input Area".

3. Input the lower-case letter

Refer to the operation specified in the previous step. If the Caps key is not selected, directly input the lower-case letter.

4. Input numbers or symbols

If the letter keypad is displayed, you need to click or tap the numeric switchover key to switch to the numeric keypad, and input numbers or symbols with the numeric keypad. All the input letters will be displayed in the "Name Input Area".

5. Modify or delete the unwanted characters that have been input

During the name input process, you can modify or delete the unwanted character if necessary. To delete the characters that have been entered, click or tap the

Backspace key in the virtual keypad. To modify the characters that have been input, delete the unwanted characters first and then input the new characters.

You can directly move the cursor to the character to be modified or deleted, delete the desired character or input the new characters after deleting the unwanted character.

6. Confirm the input

After completing the input operation, click or tap "OK".

Input a Value

When setting or modifying a parameter, input an appropriate value with the keypad in [Figure 4.21](#).

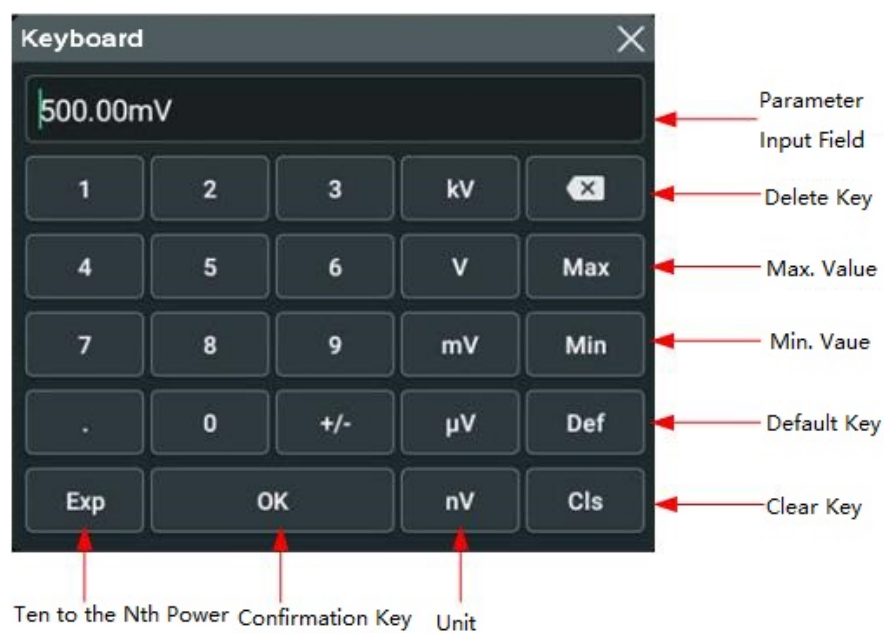



Figure 4.21 Numeric Keypad

Click or tap the value or unit in the numeric keypad to complete the input. After you input all the values and select the desired units, the numeric keypad is turned off automatically. This indicates that you have completed parameter setting. Besides, after you have input the values, you can also press "OK" directly to close the numeric keypad. At this time, the unit of the parameter is the default unit. In the numeric keypad, you can perform the following operations:

- Delete the parameter value that has been input;
- Set the parameter value to a maximum or minimum value;
- Set the parameter to a default value.
- Clear the parameter input field.

4.7 To Use the Built-in Help System

The help system of this oscilloscope provides instructions for all the function keys on the front panel and their corresponding menu keys. Click or tap  > **Help** to enter the help system.

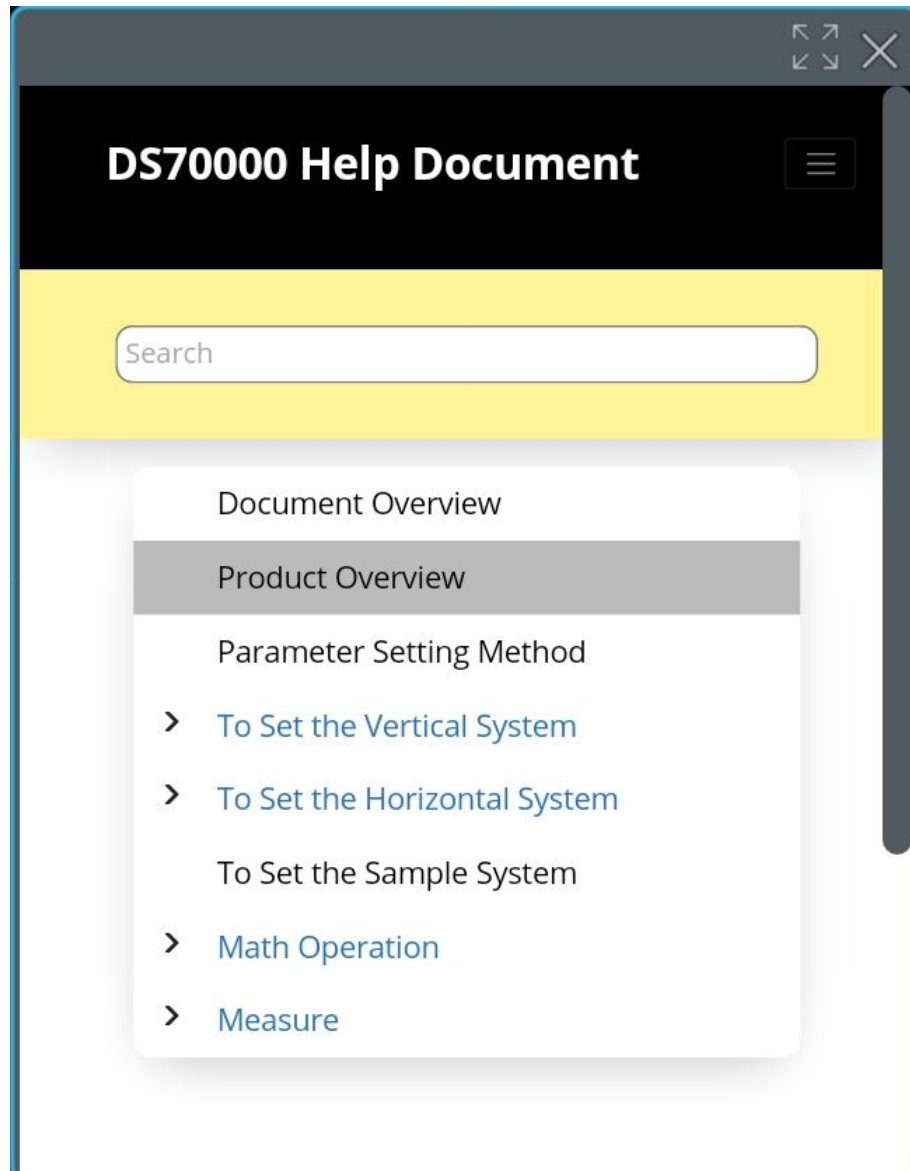

Figure 4.22 Help Information

After opening the help interface, you can get its help information by clicking on or tapping the link for the desired item.

4.8 To View the Option Information and the Option Installation

DS70000 series oscilloscope provides multiple options to fulfill your measurement requirements. If you need any of these options, order them according to the Order No. available in "*Appendix A: Options and Accessories*", and then install the options according to this section. Besides, you can also view the options currently installed on the oscilloscope or activate the newly purchased option.

1. View the installed option

The instrument is installed with the trial versions of the options before leaving factory. When you power on the instrument for the first time, the trial time is about 2,160 minutes. If your instrument has currently installed the options, perform the following operations to view the name of the installed option and other detailed information about the option.

- Click or tap the function navigation icon  at the lower-left corner of the screen, and then select **Utility** to enter the utility function menu.
- Click or tap **Option list** to view the options currently installed.

2. Install the option

The option license is a string of fixed characters. The license file should be in specific format, with the filename extension ".lic". After you purchase an option, you will obtain a key (used for obtaining desired the option license code). Then, you can install the option according to the following steps.

a. Obtain an option license

- a. Log in to the **RIGOL** official website (<http://www.rigol.com>), click **SERVICE CENTRE** > **License Activation** to enter the "Registered product license code" interface.
- b. In the software license registration interface, input the correct key, serial number (click or tap the function navigation icon  at the lower-left corner of the screen, then select **Utility** > **About** to obtain the serial number of the instrument), and verification code. Then click **Generate** to obtain the option license. If you need to use the option license file, please click the link to download the file to the root directory of the USB storage device.

b. Install the option

- a. Confirm that the option license file is located in the root directory of the USB storage device, and connect the USB storage device to the oscilloscope properly.

- b. Install the option by sending SCPI commands. For details, refer to *DS70000 Programming Guide*.
- c. After installation, a prompt message "Option activated successfully" is displayed. After the option has been installed, you are recommended to restart the instrument.

**TIP**

- Only 1 option license file of one instrument is allowed to be stored in the same USB storage device, but the USB storage device can store the option license file of several different instruments. You are not allowed to modify the licensed filename.
- During the installation process, you are not allowed to power off the instrument or pull out the USB storage device.
- Sending the SCPI commands (:SYSTEM:OPTion:INSTall <license>) to install options is supported. Installing options by inputting the license code manually is not supported.

5 To Set the Vertical System

DS70000 series oscilloscope provides four analog input channels (CH1-CH4), and each channel is equipped with an independent vertical control system. The setting methods for the vertical systems of the four channels are the same. This chapter takes CH1 as an example to introduce the setting method for the vertical system.

Enable the touch screen operation and tap the channel status label at the bottom of the screen. Then the menu shown in the following figure is displayed.

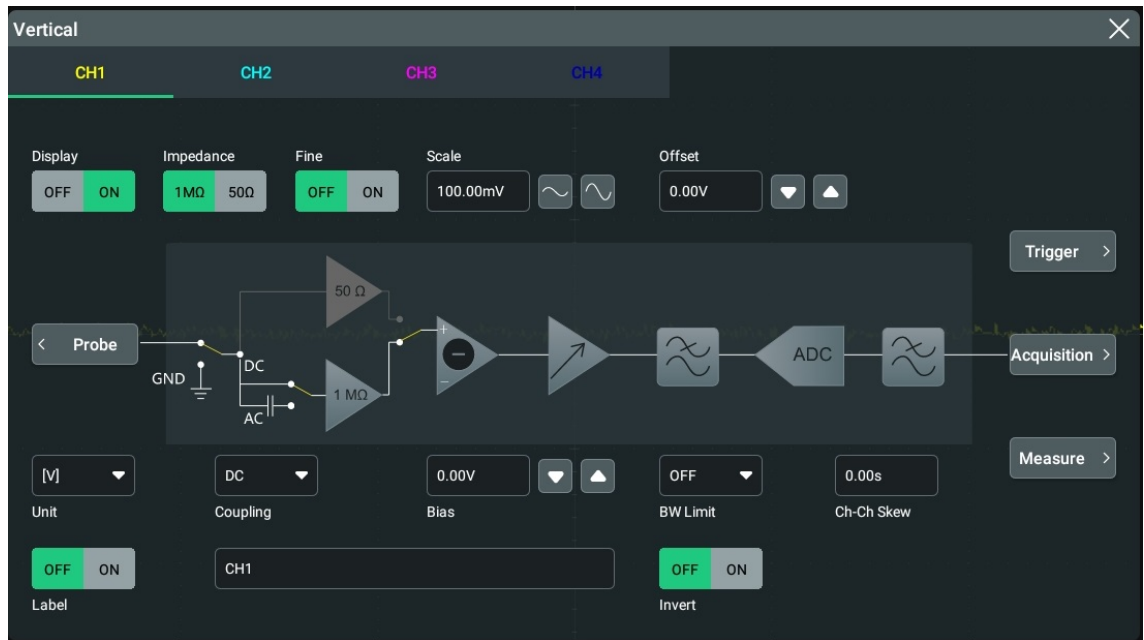



Figure 5.1 Vertical Menu for Channel

5.1 To Enable or Disable the Analog Channel

Enable the analog channel

When a signal is connected to CH1, you can enable the channel by the following methods.

- Click or tap the channel status label at the bottom of the screen to enable the channel.
- Press the front-panel key  to enable the channel, and the backlight of this key and the corresponding channel key is illuminated.
- In *To Set the Vertical System* menu, select the CH1 tab, click or tap **ON** for the **Display** menu item to turn CH1 on, and select **OFF** to turn CH1 off.

When the channel is selected, its channel status label at the bottom of the screen is shown in the figure below.



The information displayed in the channel status label is related to the current channel setting (irrelevant with the on/off status of the channel). After the channel is turned on, modify the parameters such as the vertical scale, horizontal time base, trigger mode, and trigger level according to the input signal for easy observation and measurement of the waveform.

If CH1 is enabled but not activated, the channel status label is shown in the following figure.

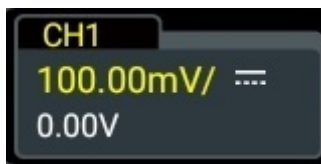

Click/tap the channel status label at the bottom of the screen or press the button



on the front panel to activate the channel CH1.

Disable the analog channel

Disable the analog channels by using the following several methods.

- If CH1 has been enabled and activated, you can press  on the front panel to disable it directly. You can also click or tap the channel status label at the bottom of the screen to disable the channel. If CH1 is disabled, the channel status label is shown in the figure below.

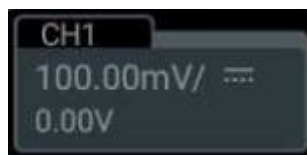

- If CH1 has been enabled but not activated, first click or tap the CH1 channel status label at the bottom of the screen, then click or tap it again to disable CH1.
- In *To Set the Vertical System*, you can also disable the channel by setting **Display** to OFF.
- Also, you can tap to slide down the channel label to disable the channel.

5.2 To Adjust the Vertical Scale

Vertical scale indicates the voltage value per grid in the vertical axis of the screen. It is often expressed in V/div. While you adjust the vertical scale, the display amplitude of

the waveform would enlarge or reduce. The scale information of the channel status label at the bottom of the screen would change accordingly.

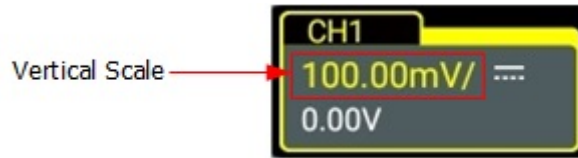

The adjustable range of the vertical scale is related to the currently set probe ratio and input impedance. By default, the probe ratio is 1X and the input impedance is 1 MΩ. In this case, the adjustable range of the vertical scale is from 1 mV/div to 10 V/div.



CAUTION

When the vertical scale is 1 mV/div and 2 mV/div, the bandwidth limit will be enabled automatically.

When CH1 is turned on, you can adjust the vertical scale with the following methods:

- Rotate the knob that corresponds to CH1 to adjust the vertical scale (clockwise to reduce the scale and counterclockwise to increase).
- Enable the touch screen function, and then adjust the vertical scale with the pinch & stretch gesture on the touch screen. For details, refer to descriptions in *Pinch&Stretch*.
- In the **Vertical** system menu, click or tap the icon at the right side of the input field of Scale to increase or decrease the scale value. You can also tap the input field to input a specific value with the displayed numeric keypad.

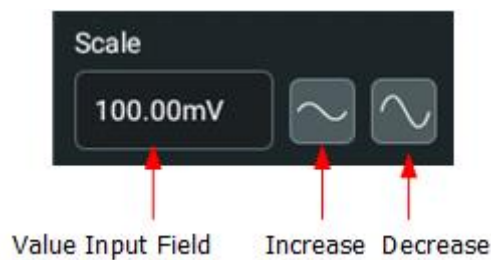

In the **Vertical** system menu, select **ON** or **OFF** to enable or disable the fine adjustment. By default, it is OFF. You can also press down the vertical scale knob on the small screen to enable or disable the fine adjustment.

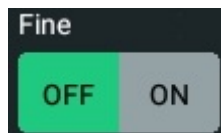

- **Fine adjustment:** Click or tap the icon at the right section of the **Scale** menu to further adjust the vertical scale within a relatively smaller range to improve vertical resolution. If the amplitude of the input waveform is a little bit greater than the full scale under the current scale and the amplitude would be a little bit

lower if the next scale is used, fine adjustment can be used to improve the amplitude of waveform display to view signal details.

- **Coarse adjustment:** Click or tap the icon at the right section of the **Scale** menu to adjust the vertical scale at 1-2-5 step, i.e. 1 mV/div, 2 mV/div, 5 mV/div, 10 mV/div...10 V/div.

5.3 To Adjust the Vertical Offset

Vertical offset indicates the offset of the signal ground level position of the waveform from the screen center in the vertical direction. Its unit is consistent with the currently selected amplitude unit (refer to "*Amplitude Unit*"). When adjusting the vertical offset, the waveforms of the corresponding channel moves up and down. The vertical offset information (as shown in the following figure) in the channel status label at the bottom of the screen will change accordingly.

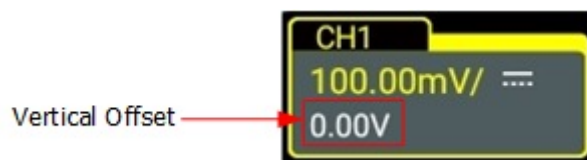

The adjustable range of the vertical scale is related to the currently set probe ratio and input impedance.

When CH1 is turned on, you can adjust the vertical scale with the following methods:

- Rotate the  **OFFSET** knob at the right section of the front panel to adjust the vertical offset within the adjustable range. Rotate this knob clockwise to increase the vertical offset, and rotate it counterclockwise to reduce the vertical offset. Pressing down the knob can quickly reset the vertical offset (set the vertical offset to 0).
- Enable the touch screen function, and then adjust the vertical offset with the drag gesture. For details, refer to the "*Drag*" section.
- Click or tap the channel status label at the bottom of the screen. Then the **Vertical** menu is displayed. Click or tap the Up and Down arrow icon at the right side of the input field of **Offset** to increase or decrease the offset value. You can also tap the input field to input a specific value with the displayed numeric keypad.

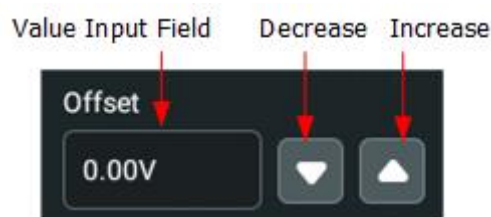

5.4 Channel Coupling

The undesired signals can be filtered out by setting the coupling mode. For example, the signal under test is a square waveform with DC offset.

Click or tap the channel status label at the bottom of the screen. Then the **Vertical** menu is displayed. Click or tap the drop-down button of the **Coupling** menu to select the coupling mode.

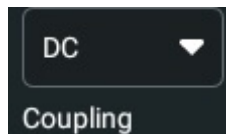

- When the coupling mode is "DC": the DC and AC components of the signal under test can both pass the channel.
- When the coupling mode is "AC": the DC components of the signal under test are blocked.
- When the coupling mode is "GND": the DC and AC components of the signal under test are blocked.

After selecting the coupling mode, the currently selected coupling mode is displayed in the channel status label at the bottom of the screen, as shown in the figure below.

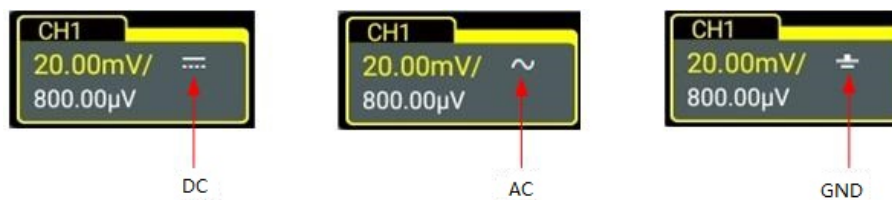

TIP

When the input impedance is set to "50 Ω", the channel coupling is set to DC coupling by force, and the **Coupling** menu is grayed out and cannot be modified.

5.5 BW Limit

This oscilloscope supports the bandwidth limit function. Setting the bandwidth limit can reduce the noises in the displayed waveforms. For example, the signal under test is a pulse with high frequency oscillation.

- When the bandwidth limit is disabled, the high frequency components of the signal under test can pass the channel.
- If you enable the bandwidth limit and limit it to 20 MHz or 250 MHz, the high frequency components found in the signal under test that are greater than 20 MHz or 250 MHz are attenuated.

Click or tap the channel status label at the bottom of the screen. Then the **Vertical** menu is displayed. Click or tap the drop-down button of the **BW Limit** menu to select the specified bandwidth. By default is OFF.

When the bandwidth limit is enabled, the character "**Bw**" will be displayed in the channel status label at the bottom of the screen.



Table 5.1 BW Limit

Input Impedance of the Oscilloscope	Available Bandwidth Limit
50 Ω	20 MHz, 250 MHz, 1 GHz or 2 GHz
1 M Ω	20 MHz, 250 MHz



TIP

Bandwidth limit can not only reduce the noise, but also can attenuate or eliminate the high frequency components of the signal.

5.6 Input Impedance

To reduce the circuit load between the oscilloscope and the circuit under test, this oscilloscope provides two input impedance modes: 1 M Ω (default) and 50 Ω . In the **Vertical** system menu, click or tap to select "1 M Ω " or "50 Ω " under **Impedance**.



- 1 M Ω : The input impedance of the oscilloscope is very high, and the current flowed from the circuit under test can be ignored.
- 50 Ω : makes the oscilloscope match with the device whose input impedance is 50 Ω .

After modifying the input impedance value, the circuit diagram in the **Vertical** system menu will also be changed, as shown in the figure below.

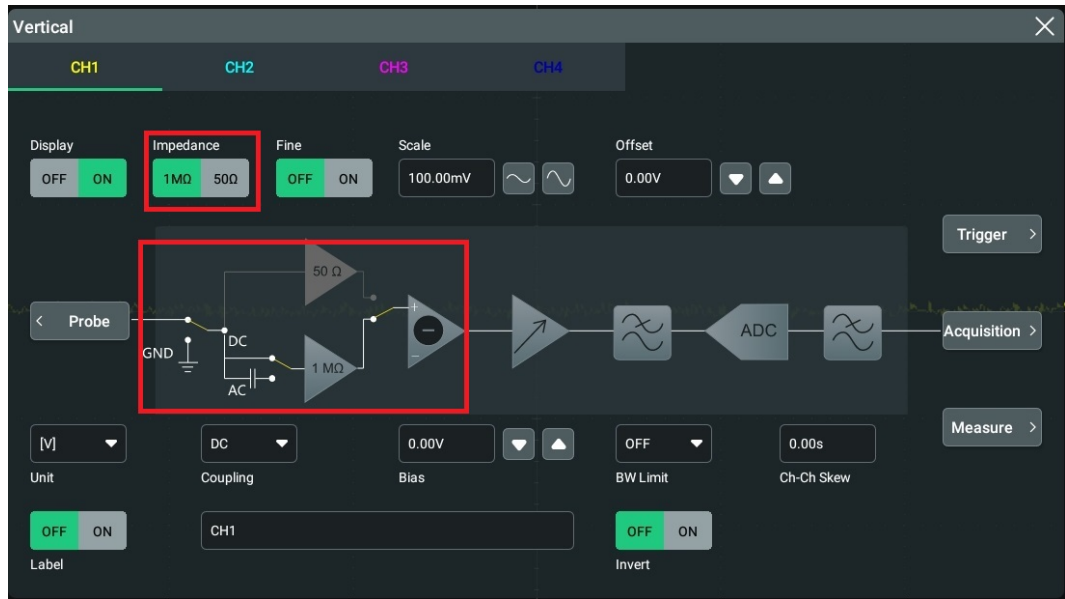

Figure 5.2 Input Impedance Modification



TIP

- After the oscilloscope recognizes the probe automatically, the input impedance will also be auto recognized. You do not have to set it manually.
- The setting of the input impedance will affect the ranges of channel vertical scale and offset.

5.7 Waveform Invert

Click or tap the channel status label at the bottom of the screen, and then the **Vertical** menu is displayed. Then click or tap the ON/OFF button for the **Invert** menu item to enable/disable the waveform invert function.

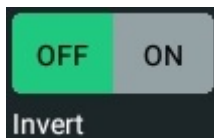

When enabled, the channel label is shown in the following figure.



When the waveform invert is turned off, the waveform is displayed normally; when the waveform invert is turned on, the voltage values of the displayed waveform are inverted, as shown in the figure below. Enabling the waveform invert will also change the result of math function, waveform measurement, etc.

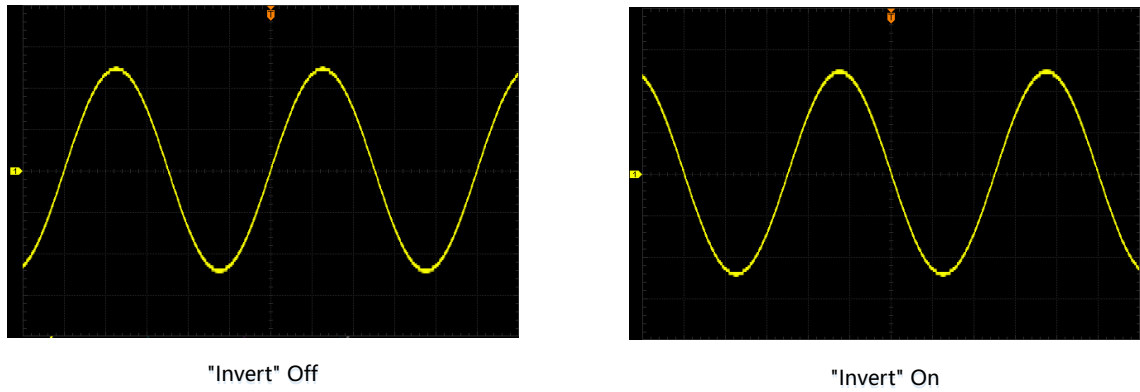

Figure 5.3 Waveform Invert



TIP

When the waveform invert is turned on, the trigger (e.g. Edge trigger, Pulse trigger, or Slope trigger) edge or polarity will be changed.

5.8 Probe

The analog channel of this oscilloscope not only supports the common passive probe, but also the active probe. It can automatically recognize the currently connected probe type and its probe ratio. For detailed technical information of the probes, please refer to the corresponding Probe User Guide.

Enable the touch screen operation and tap the channel status label at the bottom of the screen. Then the menu **Vertical** is displayed. Then click or tap **Probe** to enter the **Probe** setting menu, as shown in the figure below.

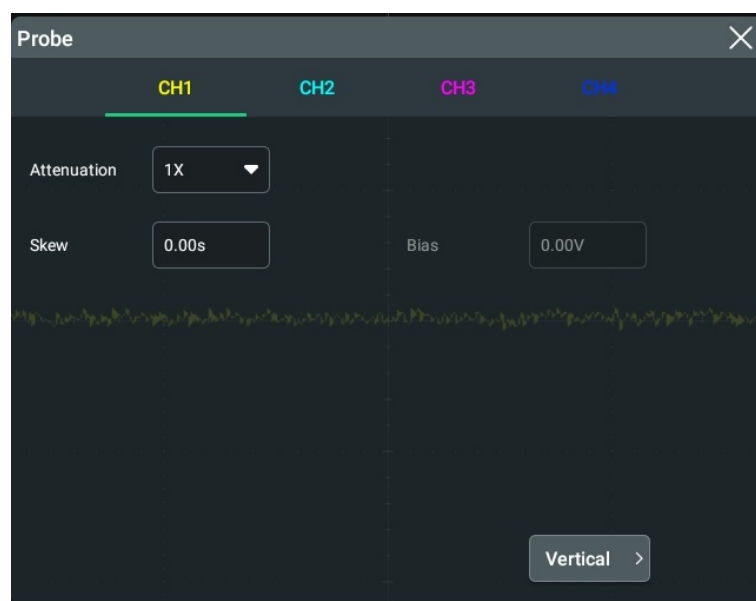

Figure 5.4 Probe Setting Menu

If the instrument works with the RP7000 series, PVA7000 series, or PVA8000 series probe, the probe menu is shown in the figure below. The probe ratio cannot be modified and you need to calibrate the probe. For specific probe models, please refer to *DS70000 Data Sheet*. For detailed technical information of the probes, please refer to the corresponding Probe User Guide.

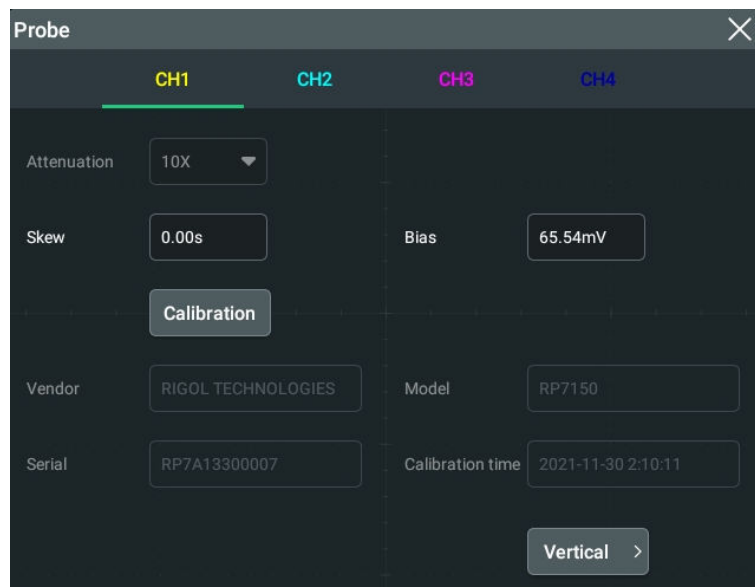

Figure 5.5 RP7000/PVA7000/PVA8000 Probe Setting Menu

Slide to select the channel number (CH1-CH4), or click/tap the channel number to switch to probe setting interface for different channels.

Probe Ratio

The oscilloscope allows you to set the probe attenuation manually. To obtain the correct measurement results, you must set the probe ratio properly. By default, the probe ratio is 1X.

The probe ratio values available are as shown in the following table.

Table 5.2 Probe Ratio

Menu	Attenuation (display amplitude of the signal: actual amplitude of the signal)
0.0001X	0.0001:1
0.0002X	0.0002:1
0.0005X	0.0005:1
0.001X	0.001:1

Menu	Attenuation (display amplitude of the signal: actual amplitude of the signal)
0.002X	0.002:1
0.005X	0.005:1
0.01X	0.01:1
0.02X	0.02:1
0.05X	0.05:1
0.1X	0.1:1
0.2X	0.2:1
0.5X	0.5:1
1X (default)	1:1
2X	2:1
5X	5:1
10X	10:1
20X	20:1
50X	50:1
100X	100:1
200X	200:1
500X	500:1
1000X	1000:1
2000X	2000:1
5000X	5000:1
10000X	10000:1
20000X	20000:1
50000X	50000:1

**TIP**

The oscilloscope auto-recognizes certain probes with a fixed attenuation ratio. After being recognized, the probe ratio will also be auto recognized. You do not have to set it manually.

Skew

Click or tap the input field of **Skew** to set the delay time for the probe. Its range is from -100.00 ns to 100.00 ns. The default value is 0.00 s.

Bias

When working with the PVA7000/PVA7000/PVA8000 series probe, you need to tap the input field of **Bias** to set the bias voltage of the probe.

Probe Information

In the probe menu, you can view information about the currently connected probe, such as the vendor, model, serial number, and the last calibration time.

Probe Calibration

Click or tap **Calibration** to start the calibration operation. Then the self-calibration window is displayed, as shown in the figure below.

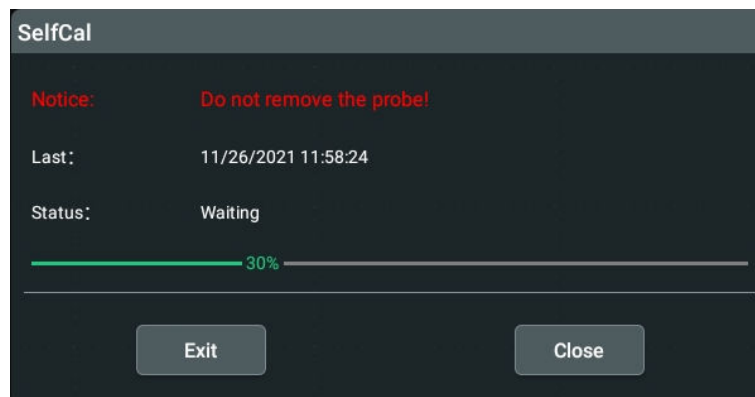

Figure 5.6 SelfCal

Click or tap **Exit** in the self-calibration window to cancel the probe calibration at any time. Click or tap **Close** to close the current self-calibration window. After completing the calibration for the probe, the measurement results can be more accurate.

TIP

If the current channel is disabled, launching the self-calibration will enable the current channel automatically. During the self-calibration, the touch-enabled operation is disabled.

Go Back to the Vertical System Menu

In the **Probe** setting menu, click or tap the **Vertical** menu to go back to the **Vertical** system menu.

5.9 Amplitude Unit

Click or tap the channel status label at the bottom of the screen, and then the **Vertical** menu is displayed. Click or tap the drop-down button of the **Unit** text box to select W, A, V, or U. The default unit is V.

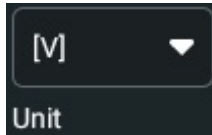

When the amplitude unit is changed, the unit related to the channel will also be changed accordingly.

5.10 Bias

When you use an oscilloscope to make actual measurements, a small offset that arises from the temperature drift of the component or external environment disturbance may occur on the zero-cross voltage of the channel, which will affect the measurement results of the vertical parameters. DS70000 series oscilloscope allows you to set an offset calibration voltage for calibrating the zero point of the corresponding channel, so as to improve the accuracy of the measurement results.

Click or tap the Up and Down arrow icon at the right side of the input field of **Bias** to increase or decrease the bias value. You can also tap the input field to input a specific value with the displayed numeric keypad.



The range of bias is related to the input impedance and the vertical scale.



TIP

If the zero-cross voltage of the channel has a larger amplitude offset that exceeds the adjustable null range, please perform self-calibration for the instrument to ensure the measurement accuracy.

5.11 Channel Delay

When using an oscilloscope for actual measurement, the transmission delay of the probe cable may bring relatively greater errors (zero offset). This series oscilloscope allows you to set a delay time for calibrating the zero offset of the corresponding channel. Zero offset is defined as the offset of the crossing point of the waveform and trigger level line relative to trigger position, as shown in the figure below.

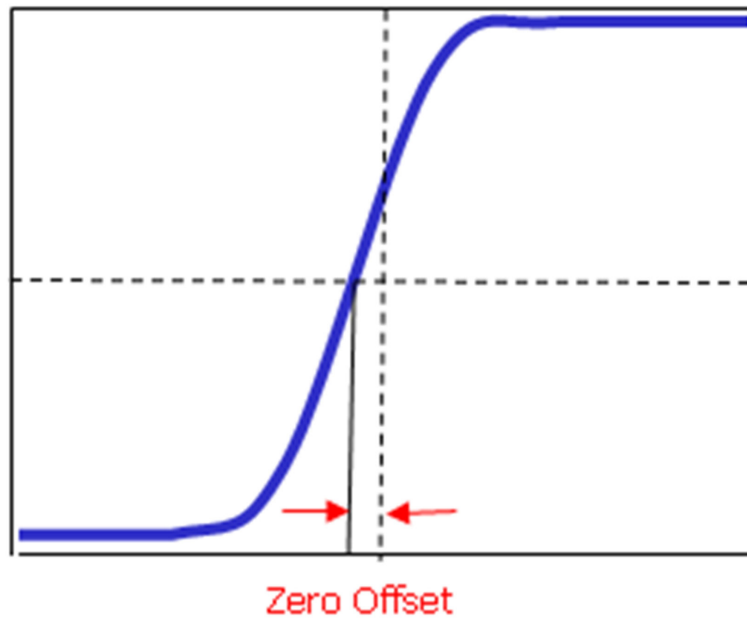

Figure 5.7 Zero Offset

In the "Vertical" menu, click or tap the input field for the **Ch-Ch Skew** item to set the channel-to-channel skew time. The available range is from -100 ns to 100 ns.

5.12 Channel Label

The instrument uses the channel number to mark the corresponding channel by default. For ease of use, you can also set a label for each channel. For example, **CH1**.

Click or tap the channel status label at the bottom of the screen. Then the **Vertical** menu is displayed. Click or tap the ON/OFF button for the **Label** menu item to select whether to display the channel label. You can also click or tap the channel label input field to input a specific name for the channel label with the pop-up numeric keypad.



For the methods of using the numeric keypad, refer to descriptions in *Parameter Setting Method*.

6 To Set the Horizontal System

To enter the **Horizontal** system menu, perform any of the following operations:

- Click or tap the channel status label at the bottom of the screen. Then the **Vertical** menu is displayed. Click or tap the **Acquisition** menu to enter the **Horizontal** system menu.
- When the multi-function knob selects the horizontal function, tap the **Horizontal** button on the small screen to enter the **Horizontal** system menu.
- Click or tap the horizontal time base label ("H" icon), acquisition label ("A" icon), or horizontal position label ("D" icon) at the top of the screen to enter the **Horizontal** system menu.

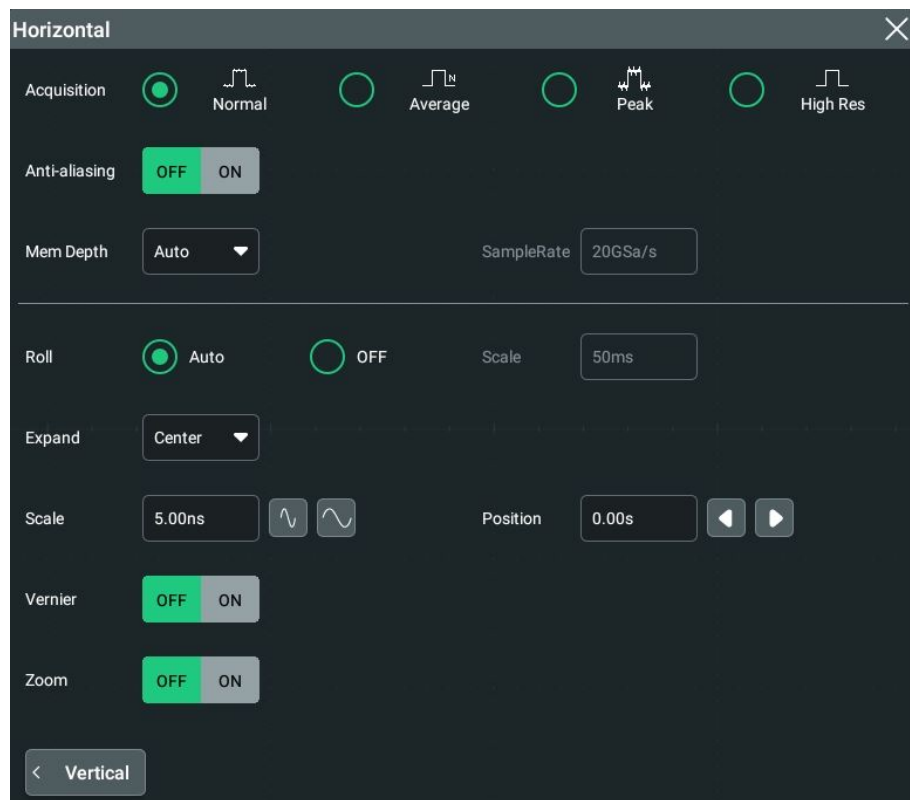
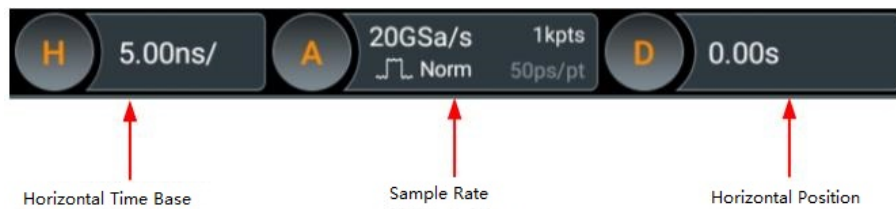

Figure 6.1 Horizontal System Menu

6.1 To Adjust the Horizontal Time Base

Horizontal time base, also called the horizontal scale, refers to the time of each grid in the horizontal direction of the screen. It is usually expressed in s/div. The range of the horizontal time base is from 50.00 ps /div to 1.00 ks/div. By default, it is 5 ns/div.

While you change the horizontal time base, the displayed waveforms of all channels are expanded or compressed (refer to *Horizontal Expansion*) horizontally relative to the current selected horizontal reference baseline. The horizontal time base at the upper-left corner of the screen will be changed accordingly, as shown in the figure below.



You can adjust the horizontal time base with the following methods.

- In the **Horizontal** system menu, click or tap the icon at the right side of the input field of **Scale** to increase or decrease the horizontal time base. You can also click the input field to input a specific value with the displayed numeric keypad.

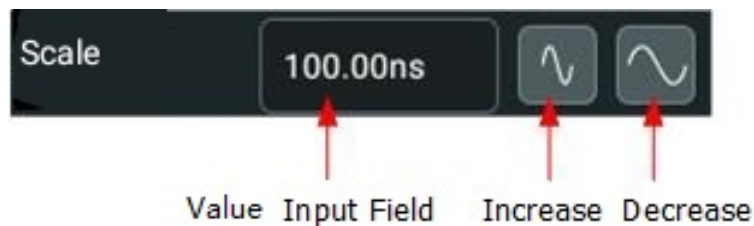

- Enable the touch screen function, and then adjust the horizontal time base with the Pinch&Stretch gesture. For details, refer to *Pinch&Stretch*.

In the **Horizontal** system menu, you can click or tap the ON/OFF tab for the **Vernier** menu to enable or disable the fine adjustment function.

- Coarse adjustment:** Click or tap the icon at the right side of the input field of **Scale** to adjust the horizontal time base of the waveforms of all channels at 1-2-5 step within the adjustable range.
- Fine adjustment:** Click or tap the icon at the right side of the input field of **Scale** to adjust the horizontal time base of the waveforms of all channels at a smaller step within the adjustable range.

6.2 To Adjust the Horizontal Position

Horizontal position, also called trigger position, refers to the trigger point position of the waveforms of all channels in the horizontal direction relative to the screen center.

When the waveform trigger point is at the left (right) side of the screen center, the horizontal position is a positive (negative) value.

While you change the horizontal position, the waveform trigger points and the displayed waveforms of all channels are moved left and right. The horizontal position at the top of the screen changes accordingly, as shown in the figure below.



You can adjust the horizontal position with the following methods.

- Enable the touch screen function, and then adjust the horizontal position with the drag gesture. For details, refer to the "*Drag*" section.
- In the "Horizontal" menu, click or tap the icon at the right side of the input field of **Position** to increase or decrease the horizontal position, as shown in the figure below.

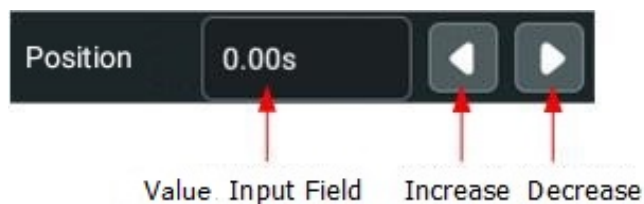

- You can also click or tap the input field of **Position** to input a specific value with the displayed numeric keypad.

6.3 Delayed Sweep

Delayed sweep can be used to enlarge a length of waveform horizontally to view waveform details. In the **Horizontal** system menu, click or tap the ON/OFF tab for the **Zoom** menu to enable or disable the delayed sweep function. When the delayed sweep is enabled, you can set the scale and offset for the delayed sweep.

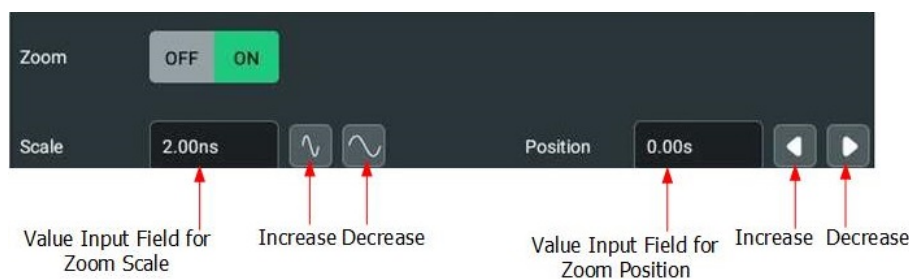

- **Scale:** Click or tap the icon at the right of the **Scale** input field under the **Zoom** menu to increase or decrease the zoom scale. You can also click or tap the value input box to input the specific value directly via the pop-up numeric keypad.

- **Position:** Click or tap the Left/Right arrow icon at the right of the **Position** input field to increase/decrease the position. You can also click or tap the value input box to input the specific value directly via the pop-up numeric keypad.

In delayed sweep mode, the screen is divided into two display areas, as shown in the following figure.

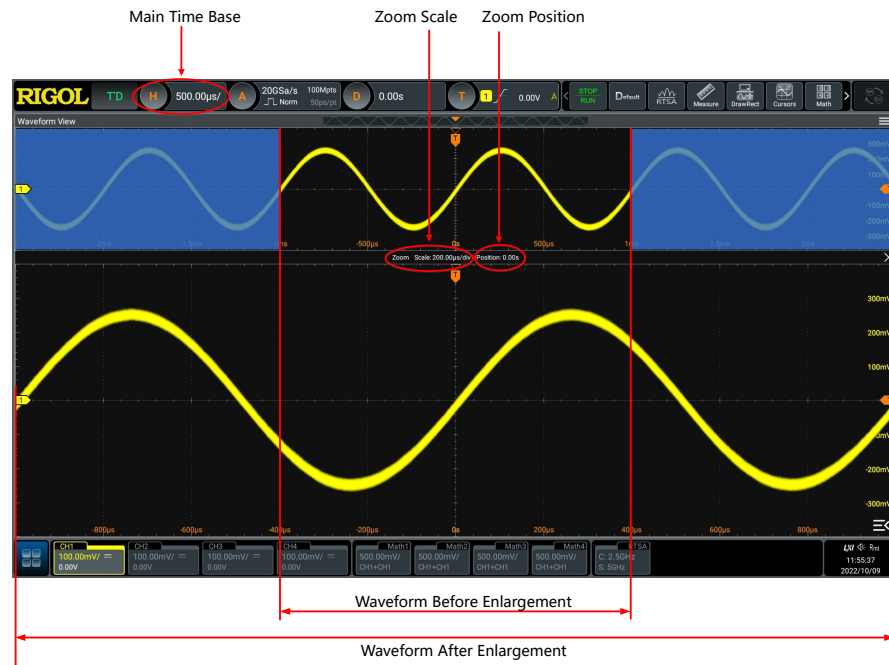

Figure 6.2 Delayed Sweep Mode

- **Waveform before enlargement:**
The waveform in the area that is not covered by subtransparent blue in the upper part of the screen is the waveform before enlargement. Its horizontal time base (also called main time base) is displayed at the upper-left corner of the screen. You can move the area left and right by adjusting the horizontal position; increase or decrease the size of the area by adjusting the horizontal scale.
- **Waveform after enlargement:**
The waveform in the lower part of the screen is the horizontally expanded delayed sweep waveform. Its horizontal time base (also called the time base of the delayed sweep) is displayed on the screen. Compared with the main time base, the time base of the delayed sweep has increased the waveform resolution.

TIP

The time base of the delayed sweep should be smaller than or equal to the main time base.



7 To Set the Sample System

You can set the sample system in the *To Set the Horizontal System* menu.

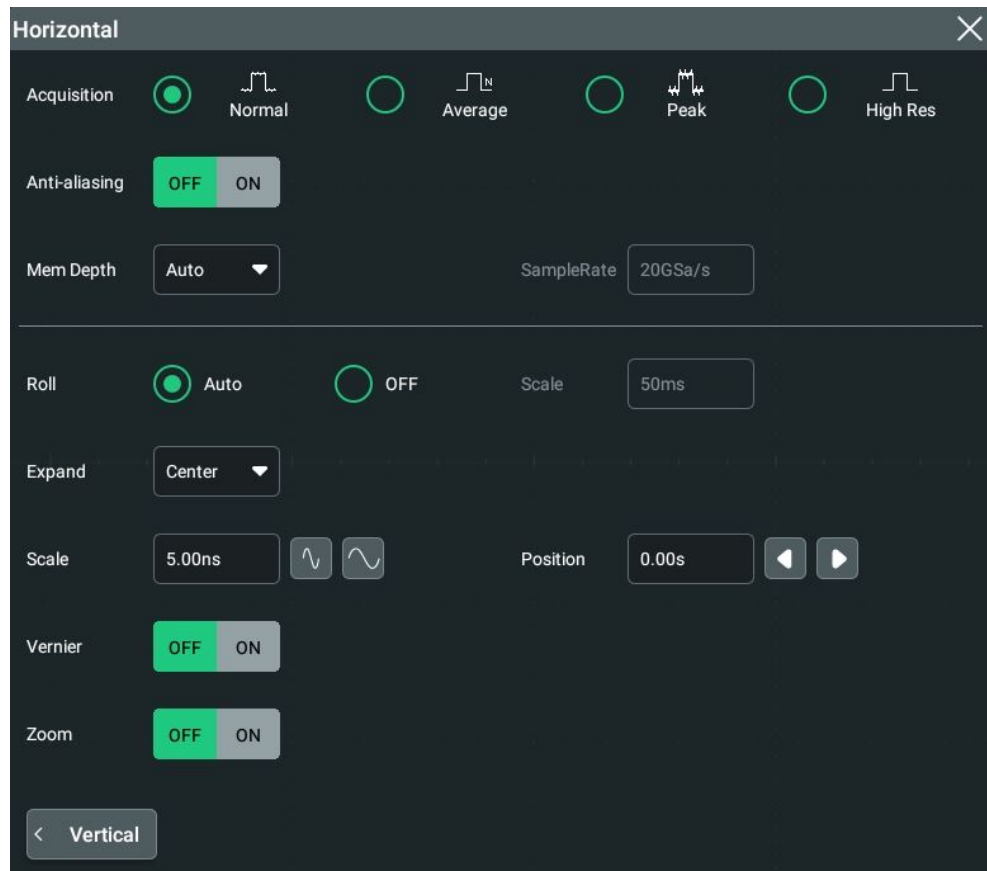

Figure 7.1 Horizontal System Menu

7.1 Acquisition Mode

The acquisition mode is used to control how to generate waveform points from the sample points. In the **Horizontal** system menu, click or tap the desired acquisition mode for the **Acquisition** menu. The available choices include Normal, Average, Peak, High Res. By default, the acquisition mode is Normal. The acquisition mode will be displayed in the acquisition label at the top of the screen.



Normal

In this mode, the oscilloscope samples the signal at a specified fixed time interval to rebuild the waveform. For most of the waveforms, using this mode can produce the optimal display effects.

Average

In this mode, the oscilloscope averages the waveforms from multiple samples to reduce the random noise of the input signal and improve the vertical resolution. Greater number of averages can lower the noise and increase the vertical resolution; while at the same time, it will slow the response of the displayed waveform to the waveform changes.

When you select "Average" mode, click or tap the input field for the **Averages** menu item to set it by using the pop-up numeric keypad. Its range is from 2 to 65536. Its default value is 8.

TIP

The number of averages must be the Nth power of 2. When it is not in N power-of-2 increments, a prompt message "Truncation average error" is displayed. At this time, a value that is smaller than the one you input and the closest to N power-of-2 increments will be input automatically. For example, if you input 9 with the numeric keypad, the average count will be input 8 automatically.

Peak

In this mode, the oscilloscope acquires the maximum and minimum values of the signal within the sample interval to get the envelope of the signal or the narrow pulse that might be lost. In this mode, signal aliasing can be prevented, but the noise displayed would be larger.

In this mode, the oscilloscope can display all the pulses whose pulse widths are at least the same as the sample period.

High Resolution

This mode uses a kind of ultra-sample technique to average the neighboring points of the sample waveform to reduce the random noise on the input signal and generate much smoother waveforms on the screen. This is generally used when the sample rate of the digital converter is higher than the storage rate of the acquisition memory.

When you select "High Res" mode, click or tap the drop-down button of **bits** to select 9, 10, 12, 14, or 16. Its default value is 9.

TIP

- The averaging modes of the "Average" and "High Res" are different. The former uses "Multi-sample Average" and the latter uses "Single Sample Average".
- In "High Res" mode, the oscilloscope improves the measurement accuracy at the cost of bandwidth. Each time the sampling rate changes, a window displaying the current bandwidth appears in the sample rate menu.

7.2 Sampling Mode

This oscilloscope only supports the real-time sampling mode. In this mode, the oscilloscope produces the waveform display from samples collected during one trigger event. The max. real-time sample rate of this series is 20 GSa/s. The current sample rate is displayed in the acquisition label at the top of the screen.

By default, the operating status label at the left top of the screen is in green, indicating that the instrument is undergoing real-time sampling. Then the **STOP/RUN** icon at the top of the screen is in green. Click or tap the **STOP/RUN** icon to stop sampling, then the **STOP/RUN** icon turns red. The operating status label at the left top of the screen shows STOP in red. At this time, the oscilloscope will maintain its last captured graph. You can still expand or zoom the waveforms by using the horizontal and vertical control menu.

7.3 Sample Rate

Sampling is the process of converting the analog signal into the digital signal at a specified time interval and then restoring them in sequence. The sample rate is the reciprocal of the time interval.

In the **Horizontal** system menu, "SampleRate" shows the current sample rate. The current sample rate is displayed in the acquisition label at the top of the screen, as shown in the figure below.

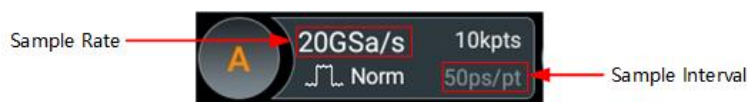

The sample rate of the analog channel is related to the current channel mode. The maximum real-time sample rate in the half-channel mode is 20 GSa/s., and the maximum real-time sample rate in the full-channel mode is 10 GSa/s.

- **Half-channel mode:** CH1 and CH2 are considered as a group; CH3 and CH4 are considered as another group. If one of the two channels in each group is enabled or one channel in either group is enabled, it is called half-channel mode.
- **Full-channel mode:** CH1 and CH2 are considered as a group; CH3 and CH4 are considered as another group. The full-channel mode meets the following conditions: two channels in either one of the groups are enabled; all of the four channels are enabled.

The impact of low sample rate on the waveform:

- **Waveform Distortion:** when the sample rate is too low, some waveform details are lost, and the sample waveform displayed is rather different from the actual waveform of the signal.

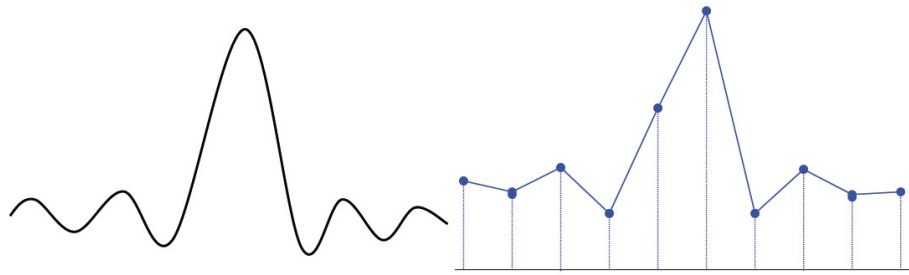

- **Waveform Aliasing:** when the sample rate is twice lower than the actual signal frequency (Nyquist Frequency), the frequency of the waveform rebuilt from the sample data is smaller than the actual signal frequency.



- **Waveform Leakage:** when the sample rate is too low, the waveform rebuilt from the sample data does not reflect all the actual signal information.

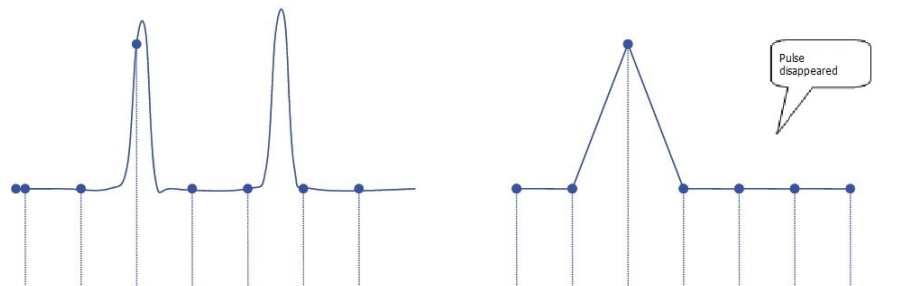

7.4 Memory Depth

Memory depth refers to the number of points of the oscilloscope that can store in one trigger acquisition. It reflects the storage capability of the acquisition storage. This oscilloscope is equipped with a standard memory depth of up to 1 Gpts (2 Gpts for option).

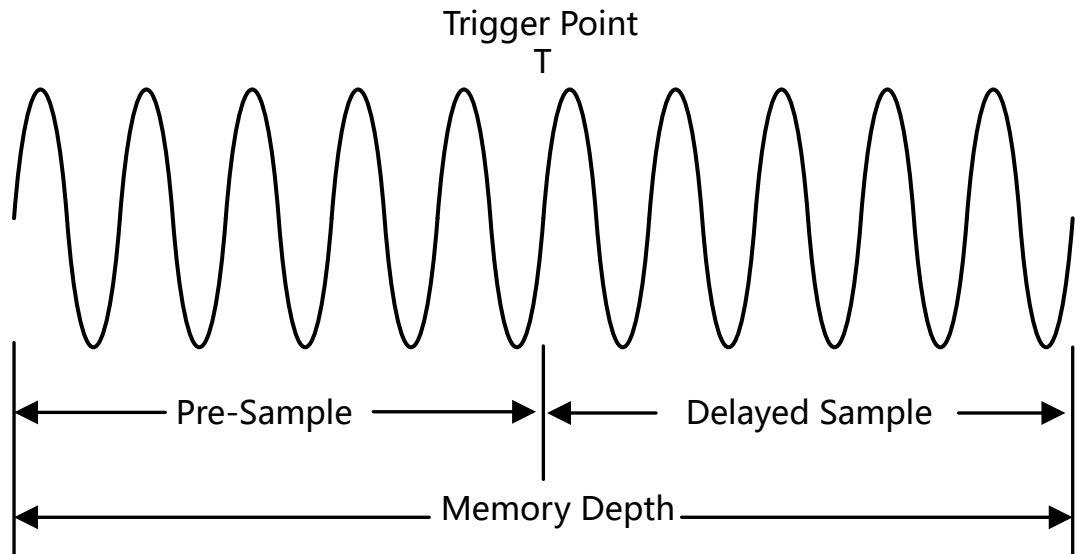

Figure 7.2 Memory Depth

The following equation shows the relations among memory depth, sample rate, and horizontal time base scale:

$$MDepth = SRate \times TScale \times HDivs$$

- **MDepth**: indicates the memory depth. The unit is pts.
- **SRate**: indicates the sample rate. The unit is Sa/s.
- **TScale**: indicates the horizontal time base scale. The unit is s/div.
- **HDivs**: indicates the number of grids in the horizontal direction. The unit is div.

Therefore, under the same horizontal time base scale, a higher memory depth can ensure a higher sample rate.

In the **Horizontal** system menu, click or tap the drop-down button of **Mem Depth** to select the memory depth. By default, the memory depth is 10 Kpts. The memory depth value will be displayed in the sample rate label at the top of the screen.

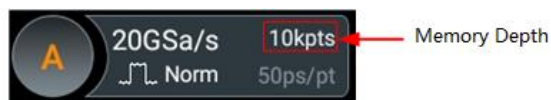

- When only one of the four channels is enabled, the memory depths available include Auto, 1 Kpts, 10 Kpts, 100 Kpts, 1 Mpts, 10 Mpts, 100 Mpts, 200 Mpts, 500 Mpts, 1 Gpts, and 2 Gpts (option).
- When any two or multiple channels are enabled, the memory depths available include Auto, 1 Kpts, 10 Kpts, 100 Kpts, 1 Mpts, 10 Mpts, 100 Mpts, 200 Mpts, 500 Mpts, and 1 Gpts.

**TIP**

In "Auto" mode, the oscilloscope selects the memory depth automatically according to the current sample rate.

7.5 Anti-Aliasing

At a slower sweep speed, the sample rate is reduced, and a dedicated display algorithm can be used to minimize the possibility of aliasing.

In the **Horizontal** system menu, the user can select the on or off tab for the **Anti-aliasing** menu to enable or disable the anti-aliasing function.

This function should be enabled when the horizontal time base has a large deviation from the period of the signal under test (e.g. when the horizontal time base is greater than five-fold the period of the signal under test).

7.6 Horizontal Expansion

Horizontal expansion indicates the reference position that the screen waveform is referenced to when it is horizontally expanded or compressed in adjusting the horizontal time base. In the **Horizontal** system menu, click or tap the drop-down button of **Expand** to select the horizontal reference baseline. The available choices include Center, Left, Right, Trigger, and User. The default is "Center".

- **Center:** when the horizontal time base is modified, the waveform will be expanded or compressed horizontally relative to the screen center.
- **Left:** when the horizontal time base is modified, the waveform will be expanded or compressed horizontally relative to the leftmost position of the screen.
- **Right:** when the horizontal time base is modified, the waveform will be expanded or compressed horizontally relative to the rightmost position of the screen.
- **Trigger:** when the horizontal time base is modified, the waveform will be expanded or compressed horizontally relative to the trigger point.
- **User:** when the horizontal time base is modified, the waveform displayed will be expanded or compressed horizontally relative to the user-defined reference position.

When you select "User", click or tap the input field of **Expand User**. Input the horizontal expansion reference value with the displayed numeric keypad. Its range is from -500 to 500. Its default value is 0.

7.7 Roll Mode

In Roll mode, the waveforms are updated rolling from right to left on the screen. You do not need to wait until all the complete waveforms are acquired. You can see the acquired data points at any time during its acquisition. In the **Horizontal** system menu, click or tap to select "Auto" or "OFF" for the **Roll** menu.

- Auto: enables the Roll mode. When the horizontal time base is set to 50 ms/div or lower than the value, the instrument automatically enters the roll mode.
- OFF: disables the Roll mode. In this mode, when the horizontal time base is set to 200 ms/div or lower than this value, the instrument enters slow sweep mode. In this mode, the instrument first acquires the data at the left of the trigger point and then waits for a trigger event. After the trigger occurs, the instrument continues to generate the waveform at the right of the trigger point. When observing the low-frequency signal in the slow sweep mode, it is recommended that you set "*Channel Coupling*" to "DC".



TIP

- If the current delayed sweep is enabled, then when you enable the Roll mode, the delayed sweep is disabled automatically.
- The following functions are not available when the Roll mode is enabled:

To Adjust the Horizontal Position (available when the operating status of the oscilloscope is in STOP state), *Delayed Sweep*, *To Trigger the Oscilloscope*, *Protocol Decoding*, *Pass/Fail Test*, *Waveform Recording and Playing*, *Persistence Time*, *XY Mode*, and *Average*.

7.8 XY Mode

By default, DS70000 series digital oscilloscope uses the YT mode for waveform display window. In this mode, Y-axis indicates the Voltage, X-axis indicates the Time. Besides, it supports XY display window. In this display window, X-axis and Y-axis indicate voltage. The two input channels display from "Voltage-Time" to "Voltage-Voltage".

Open the XY Window

To open the XY window, perform the following operations:

- Click or tap the **Windows** icon in the function navigation menu to enter the **Add Window** interface. In the Diagram menu, click or tap "XY", and then click or tap **Add** to open the XY mode display window.
- Click or tap the **XY** icon at the upper-right part of the screen to open the XY window.

Configure the XY Window

Click or tap  at the upper-right corner of the XY window to enter the XY configuration menu.

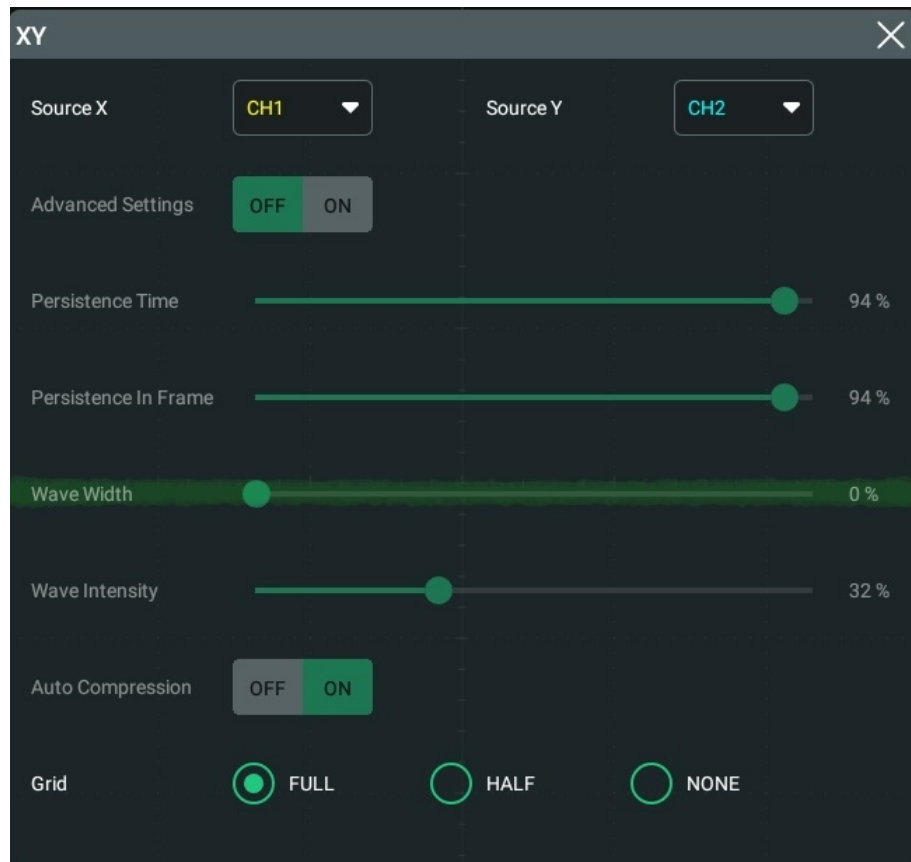

Figure 7.3 XY Setting Menu

- **Source:** Click or tap the drop-down button of "Source X" to select the source channel of the X-axis in the XY window. Click or tap the drop-down button of "Source Y" to select the source channel of the Y-axis in the XY window.

In the *Add Window* menu, you can also configure Source Z. Source Z, as the Z-axis input in the XY display mode, is used to control whether to display the X-Y waveforms in the XY display mode. This function is called "blanking".

- When "None" is selected for "Source Z", the blanking function is disabled, and you can only see the X-Y waveforms.
- When you select "CH1-CH4" for "Source Z", the blanking function is enabled. The Z-axis input from the external connector determines whether to display the X-Y waveforms. When Z is high (the input level is greater than 0 V), the X-Y waveforms are displayed; when Z is low (the input level is smaller than 0 V), the waveforms are hidden.
- **Grid:** Refer to *To Set the Screen Grid*.

**NOTE**

Advanced settings are not supported temporarily. The current settings show the most optimal display effects.

Phase Deviation Measurement

In this mode, you can use the Lissajous method to measure the phase deviation of the two input signals whose frequencies are the same. The following figure shows the measurement schematic diagram of phase deviation.

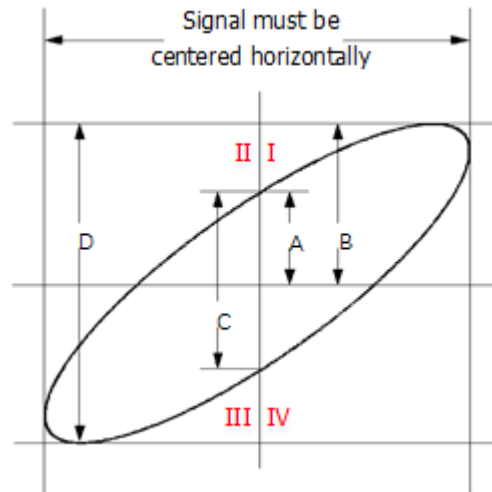

Figure 7.4 Measurement Schematic Diagram of Phase Deviation

According to $\sin\theta = A/B$ or C/D , θ is the phase deviation angle between the two channels. The definitions of A, B, C, and D are shown in the above figure. The phase deviation angle is obtained, that is:

$$\theta = \pm \arcsin(A/B) \text{ or } \pm \arcsin(C/D)$$

If the principal axis of the ellipse is within Quadrant I and III, the phase deviation angle obtained should be within Quadrant I and IV, namely within $(0 \text{ to } \pi/2)$ or $(3\pi/2 \text{ to } 2\pi)$. If the principal axis of the ellipse is within Quadrant II and IV, the phase deviation angle obtained should be within Quadrant II and III, namely within $(\pi/2 \text{ to } \pi)$ or $(\pi \text{ to } 3\pi/2)$.

The XY mode can be used to measure the phase deviation occurred when the signal under test passes through a circuit network. Connect the oscilloscope to the circuit to monitor the input and output signals of the circuit.

8 To Trigger the Oscilloscope

As for trigger, you set certain trigger condition according to the requirement and when a waveform in the waveform stream meets this condition, the oscilloscope captures this waveform as well as the neighboring part, and displays them on the screen. For the digital oscilloscope, it samples waveform continuously no matter whether it is stably triggered, but only stable trigger can be stably displayed. The trigger module ensures that every time base sweep or acquisition starts from the user-defined trigger condition, namely every sweep is synchronous with the acquisition and the waveforms acquired is overlapped so as to display the stable waveforms.

Trigger settings should be based on the features of the input signal. To quickly capture the desired waveform, you need to understand the signal under test. This oscilloscope provides abundant trigger types that help you focus on the desired waveform details.

To enter the **Trigger** menu, perform any of the following operations:

- Click or tap the trigger information label at the top of the screen to enter the trigger setting menu.



- When the multifunction knob selects the trigger function, tap the **Trigger** icon on the small screen at the right side of the large screen to enter the trigger setting menu.
- In *To Set the Vertical System*, click or tap the **Trigger** button to enter the trigger setting menu.

8.1 Trigger Source

In the "Trigger" menu, click or tap the drop-down button of **Source** to select the desired source from the drop-down list. Analog channels (CH1-CH4), AC Line, or EXT (external trigger) can all be selected as the trigger source.

Analog channel input

Signals input from analog channels CH1-CH4 can all be used as trigger sources. No matter whether the channel selected is enabled, the channel can work normally.

AC line input

The trigger signal is obtained from the AC power input of the oscilloscope. AC trigger is usually used to measure signals relevant to the AC power frequency. For example,



stably triggering the waveform output from the transformer of a transformer substation. It is mainly used in related measurements of the power industry.

External trigger input



The external trigger source can be used to trigger on the fifth channel while all the other four channels are acquiring data. The trigger signal (e.g. external clock or signal of the circuit under test) will be connected to **EXT** trigger source via the external trigger input terminal **[EXT]** connector. You can set the trigger conditions within the range of the trigger level (from -8 V to +8 V).

8.2 Trigger Level

The adjustment of the trigger level is related to the type of the trigger source.

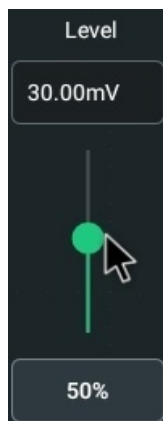
- When the trigger source is CH1-CH4, and when the multifunction knob selects the trigger function, rotate the knob  at the upper-right part of the small screen or drag the adjustment icon (as shown in the figure below) under the **Level** menu to adjust the trigger level. During the adjustment, a trigger level line (the color of the trigger level line is the same as that of the channel) and a trigger label " " are displayed on the screen, and they move up and down with the variation of the trigger level. When you stopping modifying the trigger level, the trigger level line disappears in about 2 s. The current trigger level is displayed in the the trigger information label at the top of the screen.



In Runt Trigger, Slope Trigger, and Window trigger, you need to set the upper and lower limits of the trigger level. Rotate the knob  at the upper-right part of the small screen or drag the adjustment icon under the **Level** menu to adjust the trigger level. Two trigger level labels  and  are displayed at the right section of the screen.

- When the trigger source is AC Line, there is no trigger level.

- When the trigger source is EXT, rotate the knob  at the upper-right part of the small screen or drag the adjustment icon under the **Level** menu to adjust the trigger level. The current trigger level is displayed in the the trigger information label at the top of the screen.

For this trigger source, only the variation of the trigger level value is displayed on the screen during the adjustment of the trigger level, without displaying the trigger level lines on the screen.

To ensure the waveforms to be better triggered, for a trigger with a single level, you can directly click or tap "50%" in the level menu or press down the trigger level knob to make the level move to the middle of the waveform. However, for a trigger (e.g. Slope trigger, Runt trigger, Window trigger, and MIL-STD-1553) with two levels, you need to click or tap "90%" and "10%" in the level menu or press down the trigger level knob to make the level move to within the range of the waveform amplitude.

8.3 Trigger Mode

The following is the schematic diagram of the acquisition memory. To easily understand the trigger event, we classify the acquisition memory into the pre-trigger buffer and post-trigger buffer.

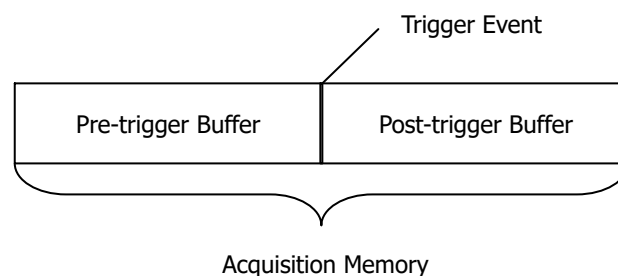



Figure 8.1 Schematic Diagram of the Acquisition Memory

After the system runs, the oscilloscope operates by first filling the pre-trigger buffer. It starts searching for a trigger after the pre-trigger buffer is filled. While searching for the trigger, the data sampled will still be transmitted to the pre-trigger buffer (the new data will continuously overwrite the previous data). When a trigger is found, the pre-trigger buffer contains the data acquired just before the trigger. Then, the oscilloscope will fill the post-trigger buffer and display the data in the acquisition memory. If the acquisition is activated via  (RUN/STOP), the oscilloscope will repeat this process; if the acquisition is activated via tapping the "Single" icon on the small screen, the oscilloscope will stop after finishing a single acquisition (you can pan and zoom the currently displayed waveform).

DS70000 provides Auto, Normal, and Single trigger modes, and the default is Auto.

Click or tap the trigger information label at the top of the screen or the "Trigger" icon on the small screen to open the "Trigger" menu. Click or tap the sub-items for the **Sweep** menu to quickly switch the current trigger mode. The trigger mode is displayed in the trigger information label at the top of the screen: A (Auto), N (Normal), and S (Single).



- **Auto:** In this trigger mode, if the specified trigger conditions are not found, triggers are forced and acquisitions are made so as to display the waveforms. This trigger mode should be used when the signal level is unknown or the DC should be displayed as well as when forcible trigger is not necessary as the trigger condition always occurs.
- **Normal:** In this trigger mode, triggers and acquisitions only occur when the specified trigger conditions are found. This trigger mode should be used when the signal is with low repetition rate or only the event specified by the trigger setting needs to be sampled as well as when auto trigger should be prevented to acquire stable display.
- **Single:** In this trigger mode, the oscilloscope performs a single trigger and acquisition when the specified trigger conditions are found, and then stops. This trigger mode should be used when you need to perform a single acquisition of the specified event and analyze the acquisition result (you can pan and zoom the currently displayed waveform, and the subsequent waveform data will not overwrite the current waveform). After a single trigger mode is initiated, the operating status of the oscilloscope is in "STOP" state.

In **Normal** and **Single** trigger modes, pressing **Force** in the trigger menu or the "Force" icon on the small screen can generate a trigger signal forcibly.

8.4 Trigger Coupling

Trigger coupling decides which kind of components will be transmitted to the trigger module. Please distinguish it from "**Channel Coupling**". This function is only valid when the trigger type is Edge and the trigger source is an analog channel.

Click/tap the trigger information label at the top of the screen (as shown in the figure below) or tap the "Trigger" icon on the small screen to open the "Trigger" menu. Click or tap the drop-down button of **Coupling** to select the desired coupling mode (by default, it is DC.) from the drop-down list.



- DC: allows DC and AC components to pass the trigger path.
- AC: blocks the DC components and attenuates the signals.
- LFR: blocks the DC components and rejects the low-frequency components.
- HFR: rejects the high frequency components.



TIP

When "AC" or "LFR" is selected for the coupling mode, no trigger level lines and trigger icons are displayed. When you adjust the trigger level, you can only see the changes of the trigger level values in the trigger information label at the top of the screen.

8.5 Trigger Holdoff

Trigger holdoff can be used to stably trigger on complex repetitive waveforms that have multiple edges or other events between waveform repetitions (such as pulse series). Holdoff time indicates the time that the oscilloscope waits for re-arming the trigger module after generating a correct trigger. The oscilloscope will not trigger even if the trigger condition is met during the holdoff time and will only re-arm the trigger module after the holdoff time expires.

For example, to stably trigger the repetitive pulse series as shown in the figure below, the holdoff time should be set to a value that is greater than t_1 and smaller than t_2 .

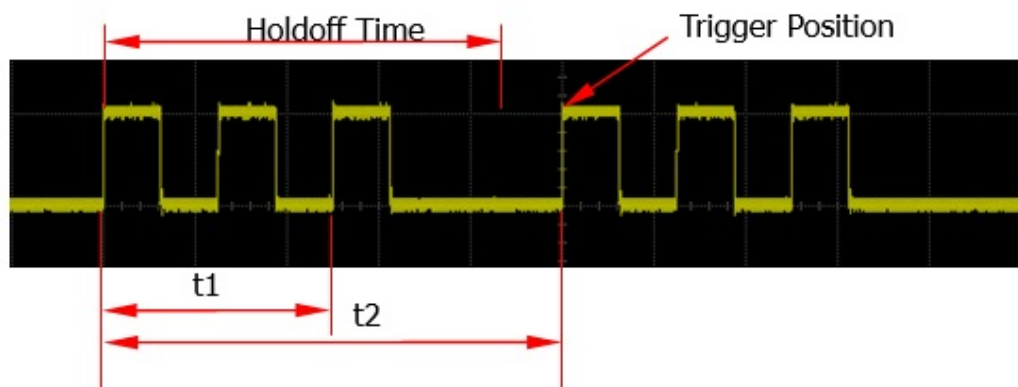
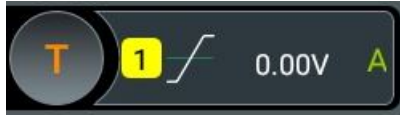

Figure 8.2 Trigger Holdoff

Click or tap the trigger information label (as shown in the figure below) at the top of the screen to open the "Trigger" menu. You can also tap the "Trigger" icon on the small screen to open the trigger menu. Click or tap the input field of **Holdoff** to input the holdoff time (the holdoff to this time when the waveforms are stably triggered; by default, the holdoff time is 8 ns) with the pop-up numeric keypad. The adjustable range of the holdoff time is from 8 ns to 10 s.



8.6 Noise Rejection

Noise rejection can reject the high frequency noise in the signal and reduce the possibility of miss-trigger of the oscilloscope.

Click or tap the trigger information label at the top of the screen or the "Trigger" icon on the small screen to open the "Trigger" menu. Click or tap the ON/OFF tab for the **Noise Reject** menu to enable or disable the noise rejection function.



TIP

This function is only valid when the trigger source is an analog channel or EXT.

8.7 Trigger Type

DS70000 series oscilloscope provides the following trigger functions.

8.7.1 Edge Trigger

Triggers on the trigger level of the specified edge of the input signal.

Trigger Type

Click/tap the trigger information label at the top of the screen or tap the **Trigger** icon on the small screen to open the "Trigger" menu. Click or tap the drop-down button of **Type** to select "Edge" from the drop-down list.

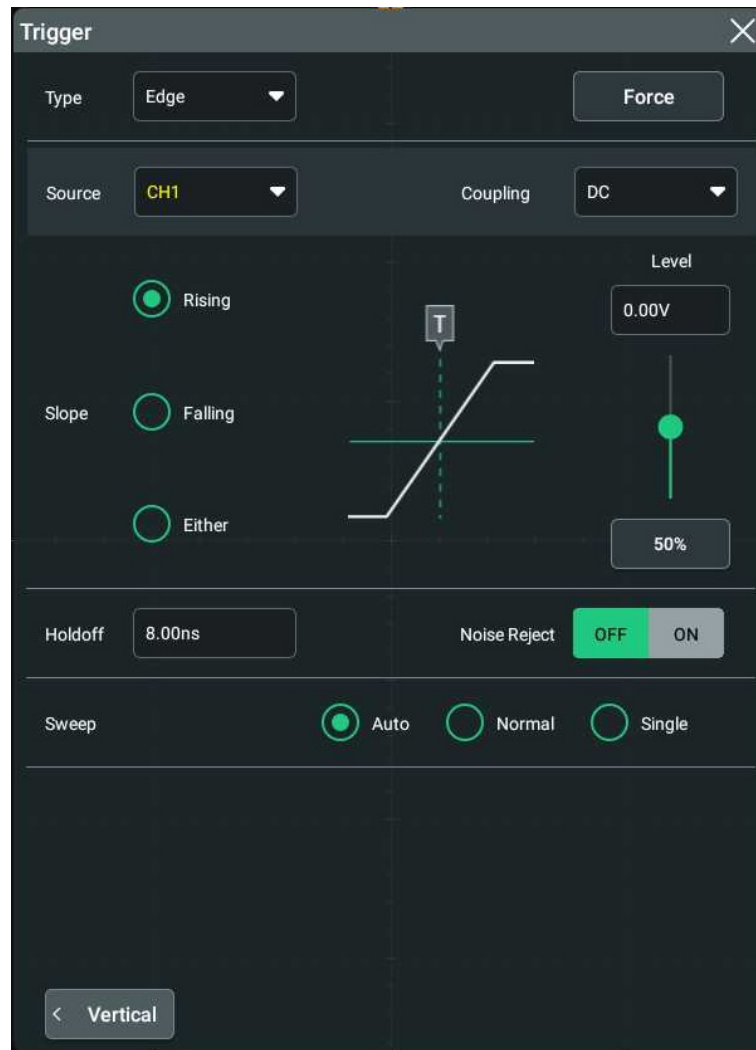

Figure 8.3 Edge Trigger Setting Menu

After selecting the trigger type, and then the current trigger setting information (including trigger type, trigger source, and trigger level) is displayed in the trigger information label at the top of the screen, as shown in the figure below. The information will change based on the trigger settings.



Source Selection

Click or tap the drop-down button of **Source** to select CH1-CH4, AC Line, or EXT. For details, refer to descriptions in *Trigger Source*. The current trigger source is displayed in the trigger information label at the top of the screen.

Only when we select the channel (that has been input with signals) as the trigger source, can we obtain a stable trigger.

Edge Type

Click or tap the sub-item for the **Slope** menu to select the input signal edge on which the oscilloscope triggers. It will be displayed in the trigger information label.

- Rising: triggers on the rising edge of the input signal when the voltage level meets the specified trigger level.
- Falling: triggers on the falling edge of the input signal when the voltage level meets the specified trigger level.
- Either: triggers on the rising or falling edge of the input signal when the voltage level meets the preset trigger level.

Trigger Mode

In **Sweep** menu, select Auto, Normal, or Single as the trigger mode. For details, refer to descriptions in *Trigger Mode*.

Trigger Parameter Setting

Sets the trigger parameters (trigger coupling, trigger holdoff, and noise rejection) under this trigger type. For details, refer to descriptions in *Trigger Coupling*, *Trigger Holdoff*, and *Noise Rejection*.

Trigger Level

Tap the "Trigger" icon on the small screen. When the multi-function knob selects the

trigger function, rotate the knob  at the upper-right part of the small screen or drag the adjustment icon under the **Level** menu to adjust the trigger level. For details, refer to descriptions in *Trigger Level*. The current trigger level is displayed in the trigger information label at the top of the screen.

8.7.2 Pulse Trigger

Triggers on the positive or negative pulse with a specified width. In this mode, the oscilloscope will trigger when the pulse width of the input signal satisfies the specified pulse width condition.

In this oscilloscope, positive pulse width is defined as the time difference between the two crossing points of the trigger level and positive pulse; negative pulse width is defined as the time difference between the two crossing points of the trigger level and negative pulse, as shown in the figure below.

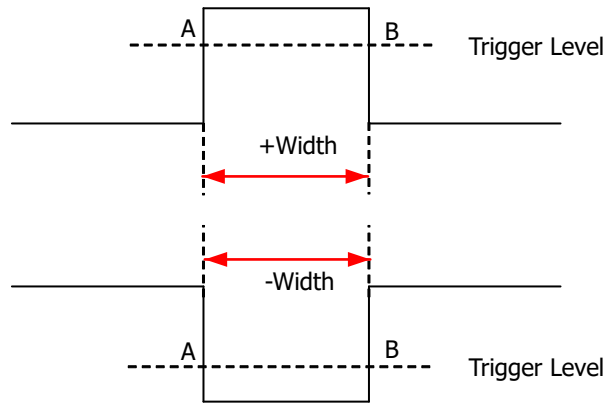

Figure 8.4 Positive Pulse Width/Negative Pulse Width

Trigger Type

Click or tap the drop-down button of **Type** to select "Pulse" from the drop-down list. Then set the parameters for Pulse trigger.

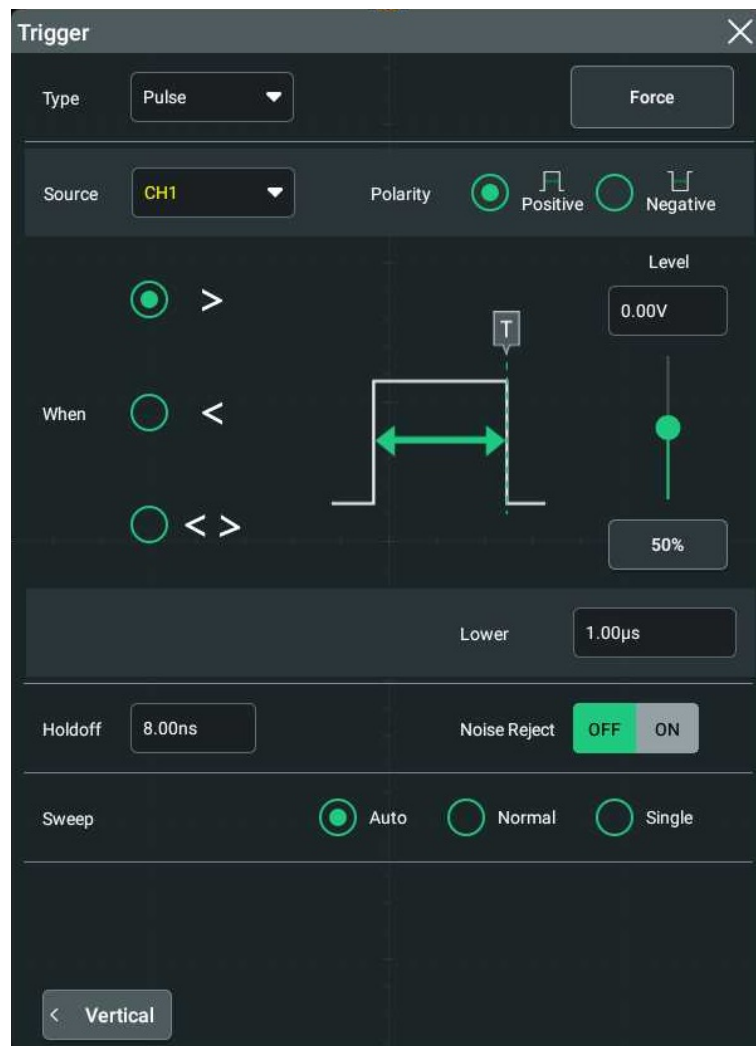

Figure 8.5 Pulse Trigger Setting Menu

After selecting the trigger type, and then the current trigger setting information (including trigger type, trigger source, and trigger level) is displayed in the trigger label at the top of the screen, as shown in the figure below. The information will change based on the trigger settings.





Source Selection

Click or tap the drop-down button of **Source** to select CH1-CH4. For details, refer to descriptions in *Trigger Source*. The current trigger source is displayed in the trigger information label at the top of the screen.

Only when we select the channel (that has been input with signals) as the trigger source, can we obtain a stable trigger.

Polarity

Selects the desired polarity under the **Polarity** menu. The polarities available are positive polarity () and negative polarity (.

Trigger Condition

Sets the trigger condition in the **When** menu.

- When you select "Positive" for polarity, ">" for trigger condition, the oscilloscope triggers when the positive pulse width of the input signal is greater than the specified pulse width.
- When you select "Positive" for polarity, "<" for trigger condition, the oscilloscope triggers when the positive pulse width of the input signal is smaller than the specified pulse width.
- When you select "Positive" for polarity, "< >" for trigger condition, the oscilloscope triggers when the positive pulse width of the input signal is greater than the specified lower limit of pulse width and smaller than the specified upper limit of pulse width.
- When you select "Negative" for polarity, ">" for trigger condition, the oscilloscope triggers when the negative pulse width of the input signal is greater than the specified pulse width.
- When you select "Negative" for polarity, "<" for trigger condition, the oscilloscope triggers when the negative pulse width of the input signal is smaller than the specified pulse width.
- When you select "Negative" for polarity, "< >" for trigger condition, the oscilloscope triggers when the negative pulse width of the input signal is greater

than the specified lower limit of pulse width and smaller than the specified upper limit of pulse width.

Pulse Width Setting

- Under the **When** menu, when ">" or "<" is set to trigger conditions, click or tap the input field of **Lower** or **Upper** to set the lower limit value or the upper limit value with the pop-up numeric keypad. The pulse range available is from 100 ps to 10 s.
- Under the **When** menu, when "< >" is set to trigger conditions, click or tap the input field of **Upper** and **Lower** respectively to set the lower limit value and the upper limit value with the pop-up numeric keypad. The lower limit of the pulse width must be smaller than the upper limit.

Trigger Mode

In **Sweep** menu, select Auto, Normal, or Single as the trigger mode. For details, refer to descriptions in *Trigger Mode*.

Trigger Parameter Setting

Sets the trigger parameters (trigger holdoff and noise rejection) under this trigger type. For details, refer to descriptions in *Trigger Holdoff* and *Noise Rejection*.

Trigger Level

Tap the "Trigger" icon on the small screen, then rotate the knob  at the upper-right part of the small screen or drag the adjustment icon under the **Level** menu to adjust the trigger level. For details, refer to descriptions in *Trigger Level*. The current trigger level is displayed in the trigger information label at the top of the screen.

8.7.3 Slope Trigger

In Slope trigger, the oscilloscope triggers on the positive or negative slope of the specified time. This trigger mode is applicable to ramp and triangle waveforms.

In this oscilloscope, positive slope time is defined as the time difference between the two crossing points of trigger level line A and B with the rising edge; negative slope time is defined as the time difference between the two crossing points of trigger level line A and B with the falling edge as shown in the figure below.

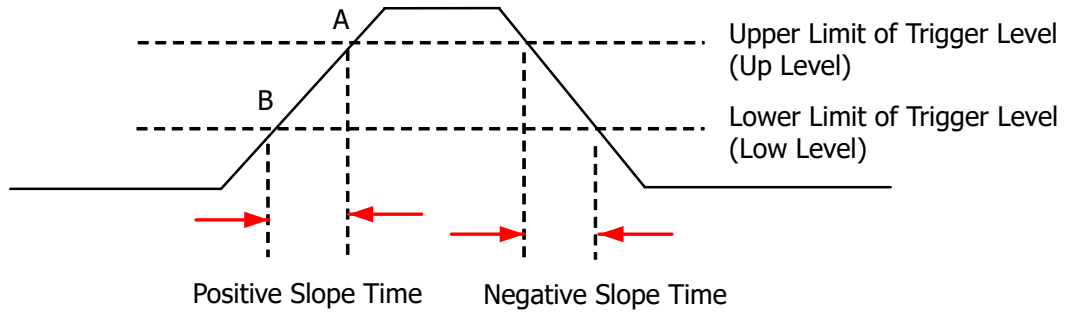

Figure 8.6 Positive Slope Time/Negative Slope Time

Trigger Type

Click or tap the drop-down button of **Type** to select "Slope" from the drop-down list. Then set the parameters for Slope trigger.

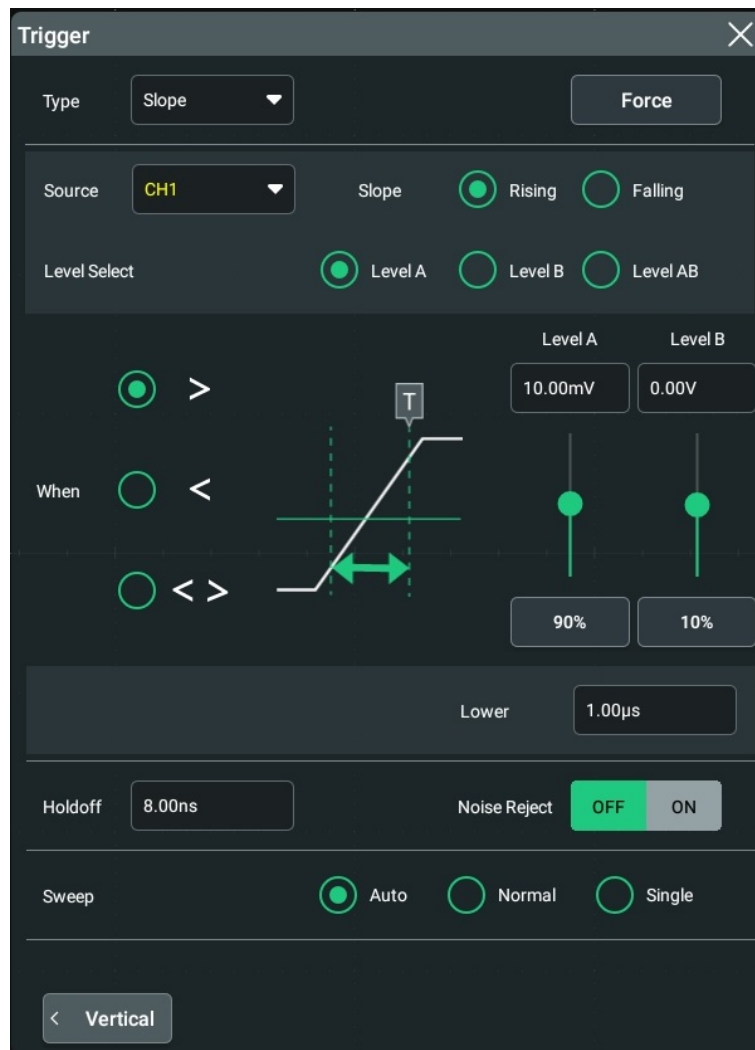

Figure 8.7 Slope Trigger Setting Menu

After selecting the trigger type, and then the current trigger setting information (including trigger type, trigger source, and trigger level) is displayed in the trigger information label at the top of the screen, as shown in the figure below. The information will change based on the trigger settings.



Source Selection

Click or tap the drop-down button of **Source** to select CH1-CH4. For details, refer to descriptions in *Trigger Source*. The current trigger source is displayed in the trigger information label at the top of the screen.

Only when we select the channel (that has been input with signals) as the trigger source, can we obtain a stable trigger.

Edge Type

Select the input signal edge (under the **Slope** menu) on which the oscilloscope triggers.

- Rising: triggers on the rising edge of the input signal.
- Falling: triggers on the falling edge of the input signal.

Trigger Condition:

Sets the trigger condition in the **When** menu.

- When you select "Rising" for the edge type, ">" for trigger condition, the oscilloscope triggers when the positive slope time of the input signal is greater than the specified time.
- When you select "Rising" for the edge type, "<" for trigger condition, the oscilloscope triggers when the positive slope time of the input signal is smaller than the specified time.
- When you select "Rising" for the edge type, "< >" for trigger condition, the oscilloscope triggers when the positive slope time of the input signal is greater than the specified lower limit time and smaller than the specified upper limit time.
- When you select "Falling" for the edge type, ">" for trigger condition, the oscilloscope triggers when the negative slope time of the input signal is greater than the specified time.
- When you select "Falling" for the edge type, "<" for trigger condition, the oscilloscope triggers when the negative slope time of the input signal is smaller than the specified time.

- When you select "Falling" for the edge type, "< >" for trigger condition, the oscilloscope triggers when the negative slope time of the input signal is greater than the specified lower limit time and smaller than the specified upper limit time.

Slope Time Setting

- Under the **When** menu, when ">" or "<" is set to trigger conditions, click or tap the input field of **Lower** or **Upper** to set the lower limit value or the upper limit value with the pop-up numeric keypad. The available range of the slope time is from 100 ps to 10 s.
- Under the **When** menu, when "< >" is set to trigger conditions, click or tap the input field of **Upper** and **Lower** respectively to set the lower limit value and the upper limit value with the pop-up numeric keypad.

The lower slope time limit must be smaller than the upper slope time limit.

Trigger Mode

In **Sweep** menu, select Auto, Normal, or Single as the trigger mode. For details, refer to descriptions in *Trigger Mode*.

Trigger Parameter Setting

Sets the trigger parameters (trigger holdoff and noise rejection) under this trigger type. For details, refer to descriptions in *Trigger Holdoff* and *Noise Rejection*.

Level Selection and Setting

After the trigger condition setting is completed, you need to adjust the trigger level to correctly trigger the signal and obtain a stable waveform.

Select the level adjustment type under the **Level Select** menu.

- Level A: only adjusts the upper limit of the trigger level, and the lower limit of the trigger level remains unchanged.
- Level B: only adjusts the lower limit of the trigger level, and the upper limit of the trigger level remains unchanged.
- Level AB: adjusts the upper and lower limits of the trigger level at the same time, and the trigger level deviation (the difference between the upper limit and lower limit of the trigger level) remains unchanged.

When setting the trigger level, first select a level type and then tap the "Trigger" icon

on the small screen, rotate the knob  at the upper-right part of the small screen or drag the adjustment icon under the **Level A** and **Level B** menu item to adjust the level of Source A and Source B. For details, refer to descriptions in *Trigger Level*. The current trigger level is displayed in the trigger information label at the top of the screen.

8.7.4 Video Trigger

The video signal can include image information and timing information, which adopts different standards and formats. DS70000 series can trigger on the standard video signal field or line of NTSC (National Television Standards Committee), PAL (Phase Alternating Line), or SECAM (Sequential Couleur A Memoire).

Trigger Type

Click or tap the drop-down button of **Type** to select "Video" from the drop-down list. Then set the parameters for Video trigger.

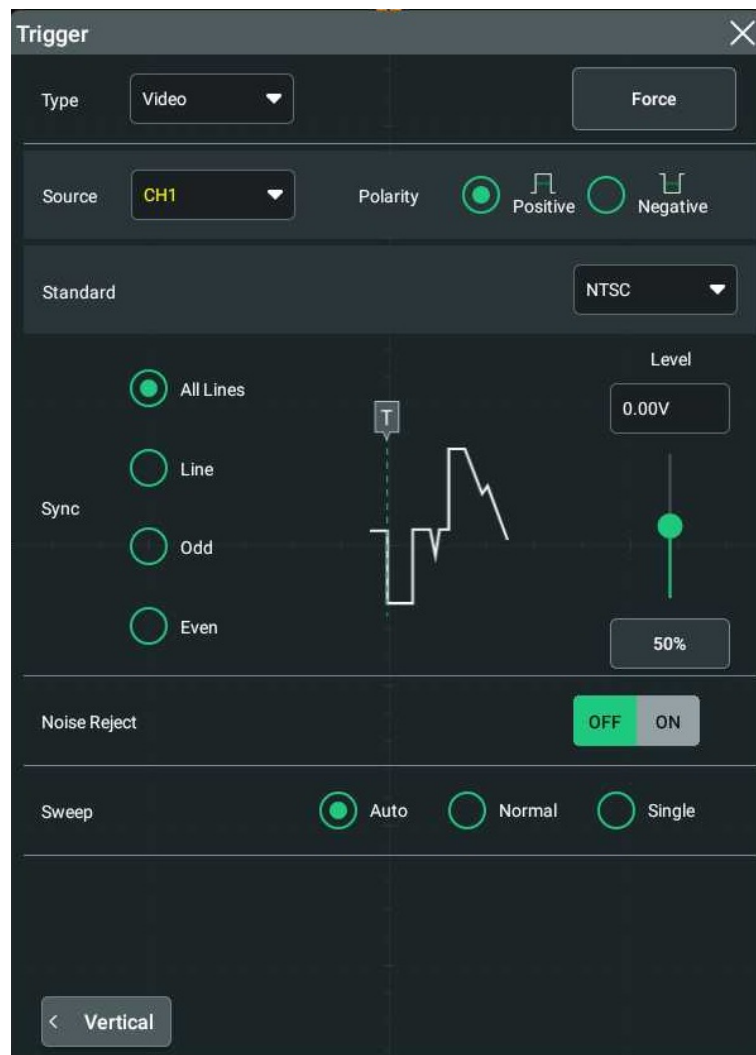
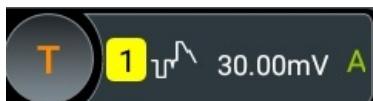

Figure 8.8 Video Trigger Setting Menu

After selecting the trigger type, and then the current trigger setting information (including trigger type, trigger source, and trigger level) is displayed in the trigger information label at the top of the screen, as shown in the figure below. The information will change based on the trigger settings.





Source Selection

Click or tap the drop-down button of **Source** to select CH1-CH4. For details, refer to descriptions in *Trigger Source*. The current trigger source is displayed in the trigger information label at the top of the screen.

Only when we select the channel (that has been input with signals) as the trigger source, can we obtain a stable trigger.

Video Polarity

Selects the desired polarity under the **Polarity** menu. The polarities available are positive polarity () and negative polarity ()

Video Standard

Click or tap the drop-down button of **Standard** to select the desired video standard.

Table 8.1 Video Standard

Video Standard	Frame Frequency (Frame)	Scan Type	TV Scan Line
NTSC	30	Interlaced Scan	525
PAL/SECAM	25	Interlaced Scan	625
480p/60Hz	60	Progressive Scan	525
576p/50Hz	50	Progressive Scan	625
720p/60Hz	60	Progressive Scan	750
720p/50Hz	50	Progressive Scan	750
720p/30Hz	30	Progressive Scan	750
720p/25Hz	25	Progressive Scan	750
720p/24Hz	24	Progressive Scan	750
1080p/60Hz	60	Progressive Scan	1125
1080p/50Hz	50	Progressive Scan	1125
1080p/30Hz	30	Progressive Scan	1125
1080p/25Hz	25	Progressive Scan	1125
1080p/24Hz	24	Progressive Scan	1125
1080i/60Hz	60	Interlaced Scan	1125
1080i/50Hz	50	Interlaced Scan	1125

Sync

Selects the desired sync type from the drop-down list of the **Sync** menu.

- All Lines: triggers on the first line found.
- Line: triggers on the specified line.

When this sync type is selected, you can specify a line number. Click or tap the input field of **Line** to set the line number by using the pop-up numeric keypad. The range of the line number is related to the currently selected video standards. The range is from 1 to 525 (NTSC), 1 to 625 (PAL/SECAM), 1 to 525 (480p), 1 to 625 (576p), 1 to 750 (720p), or 1 to 1125 (1080p/ 1080i).

- Odd: triggers on the rising edge of the first ramp pulse in the odd field. It is only available when the video standard is set to "NTSC" or "PAL/SECAM".
- Even: triggers on the rising edge of the first ramp pulse in the even field. It is only available when the video standard is set to "NTSC" or "PAL/SECAM".

Trigger Mode

In **Sweep** menu, select Auto, Normal, or Single as the trigger mode. For details, refer to descriptions in *Trigger Mode*.

Trigger Parameter Setting

Sets the trigger parameter (noise rejection) under this trigger type. For details, refer to descriptions in "*Noise Reject*".

Trigger Level

Tap the "Trigger" icon on the small screen, then rotate the knob  at the upper-right part of the small screen or drag the adjustment icon under the **Level** menu to adjust the trigger level. For details, refer to descriptions in *Trigger Level*. The current trigger level is displayed in the trigger information label at the top of the screen.

TIP

- For a better observation of the waveform details in the video signal, you can set a larger memory depth first.
- In the trigger debugging process of video signals, the frequency in different part of the signal can be reflected by a different brightness, as RIGOL's digital oscilloscope provides the intensity graded color display function. Experienced users can quickly judge the signal quality and discover abnormalities during the debugging process.



8.7.5 Pattern Trigger

Identifies a trigger condition by searching for a specified pattern. This pattern is a logical "AND" combination of channels. Each channel can be set to H (high), L (low), or X (don't care). A rising or falling edge (you can only specify a single edge) can be specified for one channel included in the pattern. When an edge is specified, the oscilloscope will trigger at the edge specified if the pattern set for the other channels are true (namely the actual pattern of the channel is the same as the preset pattern). If

no edge is specified, the oscilloscope will trigger on the last edge that makes the pattern true. If all the channels in the pattern are set to "X", the oscilloscope will not trigger.

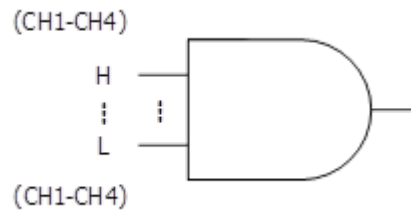

Figure 8.9 Pattern Trigger

Trigger Type

Click or tap the drop-down button of **Type** to select "Pattern" from the drop-down list. Then set the parameters for the Pattern trigger.

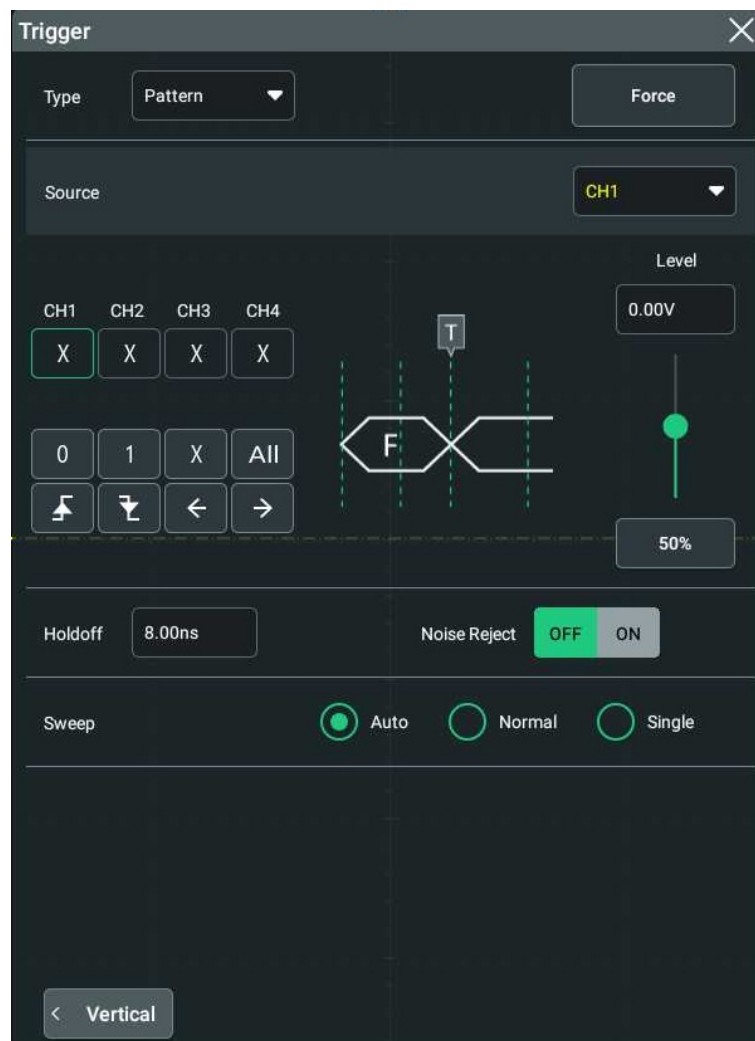

Figure 8.10 Pattern Trigger Setting Menu

After selecting the trigger type, and then the current trigger setting information (including trigger type, trigger source, and trigger level) is displayed in the trigger information label at the top of the screen, as shown in the figure below. The information will change based on the trigger settings.





Source Selection

Click or tap the drop-down button of **Source** to select CH1-CH4. For details, refer to descriptions in *Trigger Source*. The current trigger source is displayed in the trigger information label at the top of the screen.

Only when we select the channel (that has been input with signals) as the trigger source, can we obtain a stable trigger.

Pattern Setting

The following five patterns are available:

- 1: sets the pattern of the channel selected to "1", i.e. the voltage level is higher than the trigger level of the channel.
- 0: sets the pattern of the channel selected to "0", i.e. the voltage level is lower than the trigger level of the channel.
- X: sets the pattern of the channel selected to "X", i.e. this channel is not used as a part of the pattern. When all channels in the pattern are set to "X", the oscilloscope will not trigger.
- : sets the pattern to the rising edge of the channel selected.
- : sets the pattern to the falling edge of the channel selected.

The Left/Right arrow key indicates moving left/right to switch the channel pattern.

"All" indicates all bits. Select a pattern for a channel, then click or tap **All**. The patterns of all the other channels will be set to the currently selected pattern. The pattern setting is shown in the figure below:



Only one edge (rising or falling edge) can be specified in the pattern. If one edge item is currently defined and then another edge item is defined in another channel in the pattern, then a prompt message "Invalid input" is displayed.

Trigger Mode

In **Sweep** menu, select Auto, Normal, or Single as the trigger mode. For details, refer to descriptions in *Trigger Mode*.

Trigger Parameter Setting

Sets the trigger parameters (trigger holdoff and noise rejection) under this trigger type. For details, refer to descriptions in *Trigger Holdoff* and *Noise Rejection*.

Trigger Level

Tap the "Trigger" icon on the small screen, then rotate the knob  at the upper-right part of the small screen or drag the adjustment icon under the **Level** menu to adjust the trigger level. For details, refer to descriptions in *Trigger Level*. The current trigger level is displayed in the trigger information label at the top of the screen.

8.7.6 Duration Trigger

In duration trigger, the instrument identifies a trigger condition by searching for the duration of a specified pattern. This pattern is a logical "AND" combination of the channels. Each channel can be set to 1 (high), 0 (low), or X (don't care). The instrument triggers when the duration (ΔT) of this pattern meets the preset time, as shown in the figure below.

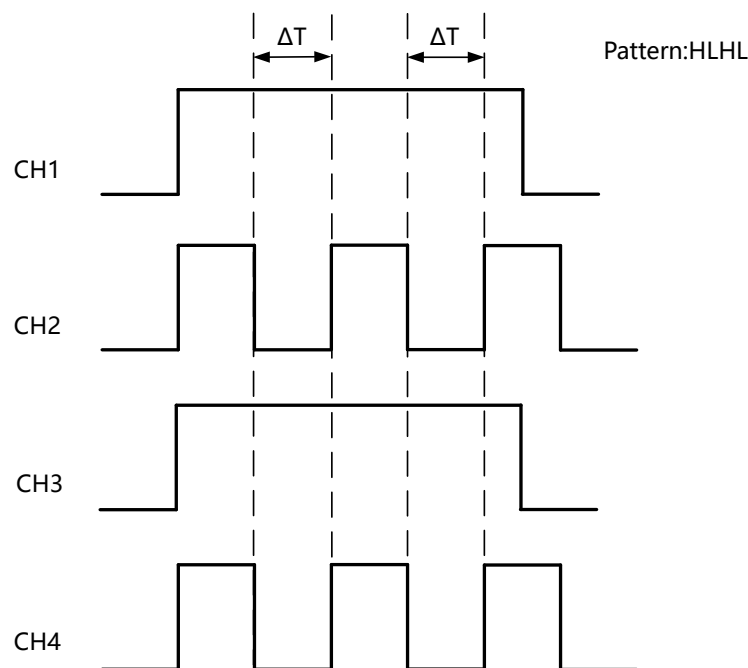

Figure 8.11 Duration Trigger

Trigger Type

Click or tap the drop-down button of **Type** to select "Duration" from the drop-down list.

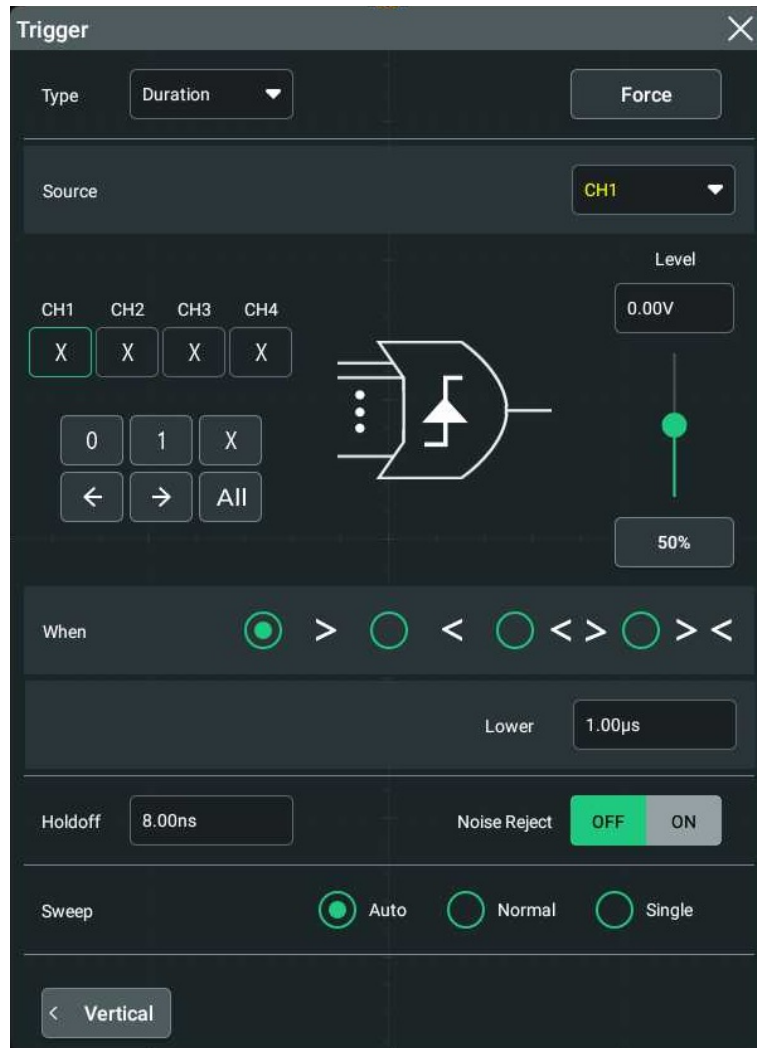

Figure 8.12 Duration Trigger Setting Menu

After selecting the trigger type, and then the current trigger setting information (including trigger type, trigger source, and trigger level) is displayed in the trigger information label at the top of the screen, as shown in the figure below. The information will change based on the trigger settings.



Source Selection

Click or tap the drop-down button of **Source** to select CH1-CH4. For details, refer to descriptions in *Trigger Source*. The current trigger source is displayed in the trigger information label at the top of the screen.

Only when we select the channel (that has been input with signals) as the trigger source, can we obtain a stable trigger.

Pattern Setting

The following three patterns are available:

- 1: sets the pattern of the channel selected to "1", i.e. the voltage level is higher than the trigger level of the channel.
- 0: sets the pattern of the channel selected to "0", i.e. the voltage level is lower than the trigger level of the channel.
- X: sets the pattern of the channel selected to "X", i.e. this channel is not used as a part of the pattern. When all channels in the pattern are set to "X", the oscilloscope will not trigger.

The Left/Right arrow key indicates moving left/right to switch the channel pattern.

"All" indicates all bits. Select a pattern for a channel, then click or tap **All**. The patterns of all the other channels will be set to the currently selected pattern.

Trigger Condition

Sets the trigger condition in the **When** menu.

- >: triggers when the duration of the pattern is greater than the preset time. Click or tap the input field of **Lower** to set the lower limit of the duration of the pattern with the pop-up numeric keypad. Its range is from 100 ps to 10 s.
- <: triggers when the duration of the pattern is smaller than the preset time. Click or tap the input field of **Upper** to set the upper limit of the duration of the pattern. Its range is from 100 ps to 10 s.
- < >: triggers when the duration of the pattern is smaller than the upper limit of the preset time and greater than the lower limit of the preset time. Click or tap the input field of **Upper** to set the upper limit of the duration of the pattern, and the range is from 101 ps to 10 s. Click or tap the input field of **Lower** to set the lower limit of the duration of the pattern, and the range is from 100 ps to 9.9 s. The lower time limit must be smaller than the upper time limit.
- > <: triggers when the duration of the pattern is greater than the upper limit of the preset time or smaller than the lower limit of the preset time. Click or tap the input field of **Upper** to set the upper limit of the duration of the pattern, and the range is from 100 ps to 10 s. Click or tap the input field of **Lower** to set the lower limit of the duration of the pattern, and the range is from 100 ps to 9.9 s. The lower time limit must be smaller than the upper time limit.

Trigger Mode

In **Sweep** menu, select Auto, Normal, or Single as the trigger mode. For details, refer to descriptions in *Trigger Mode*.

Trigger Parameter Setting

Sets the trigger parameters (trigger holdoff and noise rejection) under this trigger type. For details, refer to descriptions in *Trigger Holdoff* and *Noise Rejection*.

Trigger Level

Tap the "Trigger" icon on the small screen, then rotate the knob  at the upper-right part of the small screen or drag the adjustment icon under the **Level** menu to adjust the trigger level. For details, refer to descriptions in *Trigger Level*. The current trigger level is displayed in the trigger information label at the top of the screen.

8.7.7 Timeout Trigger

In Timeout trigger, the instrument triggers when the time interval (ΔT) (the time from when the rising edge (or falling edge) of the input signal passes through the trigger level to the time from when the neighboring falling edge (or rising edge) passes through the trigger level) is greater than the preset timeout value, as shown in *Figure 8.13*.

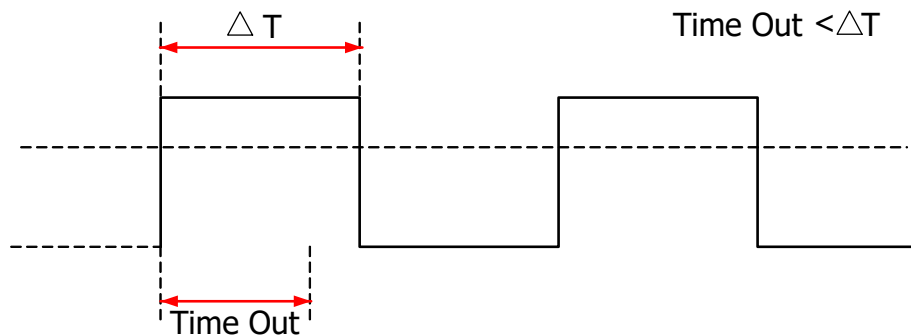

Figure 8.13 Timeout Trigger

Trigger Type

Click or tap the trigger information label at the top of the screen, and then click or tap the drop-down button of **Type** to select "Timeout" from the drop-down list. Then set the parameters for the Timeout trigger in *Figure 8.14*.

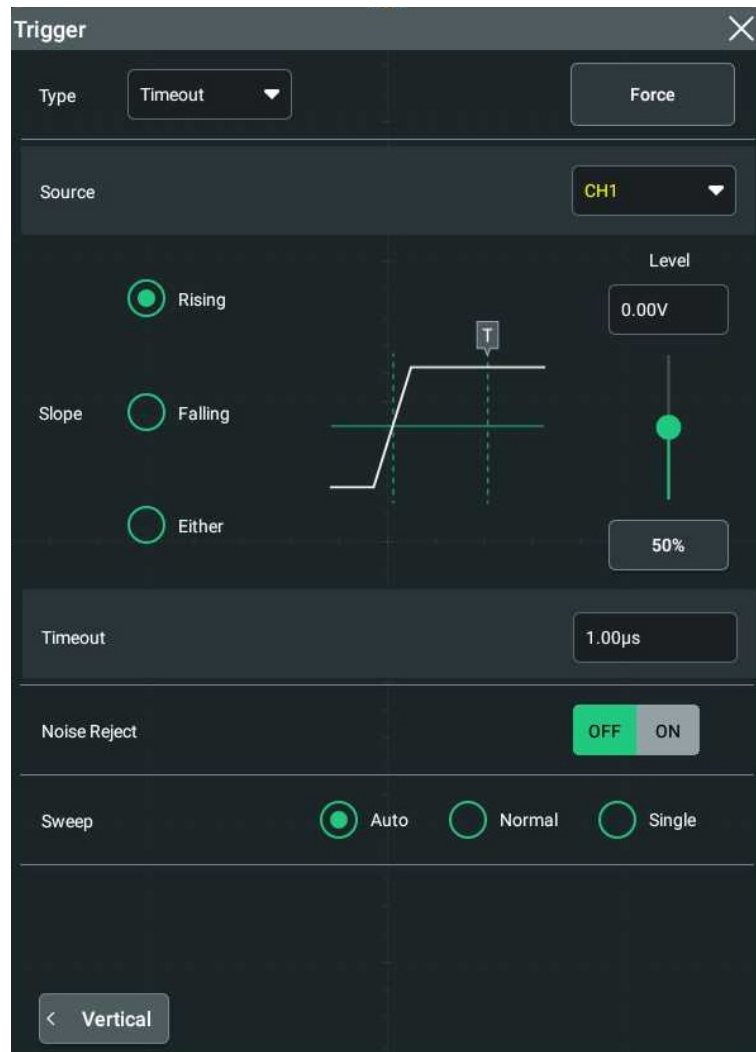
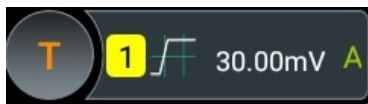

Figure 8.14 Timeout Trigger Menu

At this time, the current trigger setting information (including trigger type, trigger source, and trigger level) is displayed at the top of the screen, as shown in the figure below. The information will change based on the trigger settings.



Source Selection

Click or tap the drop-down button of **Source** to select CH1-CH4. For details, refer to descriptions in *Trigger Source*. The current trigger source is displayed in the trigger information label at the top of the screen.

Only when we select the channel (that has been input with signals) as the trigger source, can we obtain a stable trigger.

Edge Type

Click or tap the edge type (under **Slope**) from which the input signal passes through the trigger level.

- Rising: starts timing when the rising edge of the input signal passes through the trigger level.
- Falling: starts timing when the falling edge of the input signal passes through the trigger level.
- Either: starts timing when either edge of the input signal passes through the trigger level.

Timeout Value

Timeout value represents the maximum time that the signal remains idle before the signal passes through the trigger level. Click or tap the input field of **Timeout**, and then use the pop-up numeric keypad to set the timeout value of Timeout trigger. The available range is from 16 ns to 10 s.

Trigger Mode

In **Sweep** menu, select Auto, Normal, or Single as the trigger mode. For details, refer to descriptions in *Trigger Mode*.

Trigger Parameter Setting

Sets the trigger parameter (noise rejection) under this trigger type. For details, refer to descriptions in *Noise Reject*.

Trigger Level

Tap the "Trigger" icon on the small screen, then rotate the knob  at the upper-right part of the small screen or drag the adjustment icon under the **Level** menu to adjust the trigger level. For details, refer to descriptions in *Trigger Level*. The current trigger level is displayed in the trigger information label at the top of the screen.

8.7.8 Runt Trigger

This trigger mode is used to trigger pulses that pass through one trigger level but fail to pass through another trigger level, as shown in the figure below.

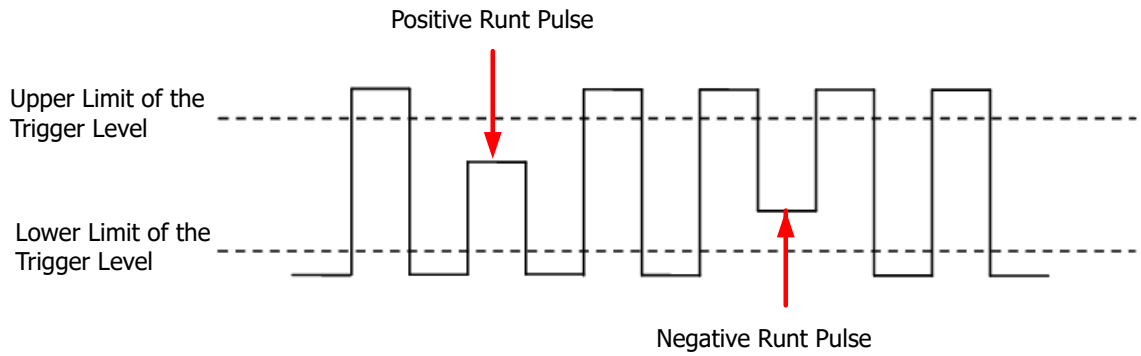

Figure 8.15 Runt Trigger

Trigger Type

Click or tap the drop-down button of **Type** to select "Runt" from the drop-down list. Then set the parameters for Runt trigger.

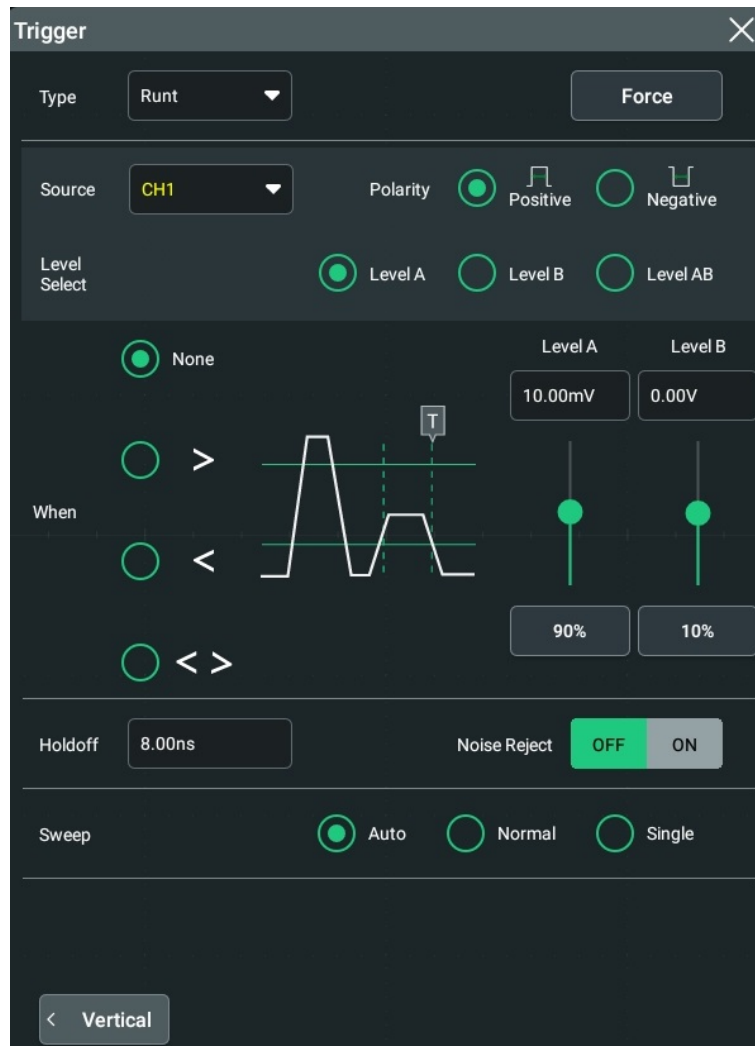

Figure 8.16 Runt Trigger Setting Menu

After selecting the trigger type, and then the current trigger setting information (including trigger type, trigger source, and trigger level) is displayed at the top of the screen, as shown in the figure below. The information will change based on the trigger settings.





Source Selection

Click or tap the drop-down button of **Source** to select CH1-CH4. For details, refer to descriptions in *Trigger Source*. The current trigger source is displayed in the trigger information label at the top of the screen.

Only when we select the channel (that has been input with signals) as the trigger source, can we obtain a stable trigger.

Polarity

Selects the pulse polarity of Runt trigger under the **Polarity** menu.

- Positive : triggers on the positive runt pulse.
- Negative : triggers on the negative runt pulse.

Trigger Condition

Sets the Runt trigger condition in the **When** menu.

- **None**: indicates not setting the trigger condition of Runt trigger.
- **>**: triggers when the runt pulse width is greater than the lower limit of pulse width. Click or tap the input field of **Lower** to set the minimum pulse width of Runt trigger with the pop-up numeric keypad.
- **<**: triggers when the runt pulse width is smaller than the upper limit of pulse width. Click or tap the input field of **Upper** to set the maximum pulse width of Runt trigger with the pop-up numeric keypad.
- **< >**: triggers when the runt pulse width is greater than the lower limit and smaller than the upper limit of pulse width. Click or tap the input field of **Upper** to set the maximum pulse width of Runt trigger with the pop-up numeric keypad. Click or tap the input field of **Lower** to set the minimum pulse width of Runt trigger with the pop-up numeric keypad. The lower limit of the pulse width must be smaller than the upper limit.

Level Selection and Setting

After the trigger condition setting is completed, you need to adjust the trigger level to correctly trigger the signal and obtain a stable waveform.

Select the level adjustment type under the **Level Select** menu.

- Level A: only adjusts the upper limit of the trigger level, and the lower limit of the trigger level remains unchanged.
- Level B: only adjusts the lower limit of the trigger level, and the upper limit of the trigger level remains unchanged.
- Level AB: adjusts the upper and lower limits of the trigger level at the same time, and the trigger level deviation (the difference between the upper limit and lower limit of the trigger level) remains unchanged.

When setting the trigger level, first select a level type and then tap the "Trigger" icon

on the small screen, rotate the knob  at the upper-right part of the small screen or drag the adjustment icon under the **Level A** and **Level B** menu item to adjust the level of Source A and Source B. For details, refer to descriptions in *Trigger Level*. The current trigger level is displayed in the trigger information label at the top of the screen.

Trigger Mode

In **Sweep** menu, select Auto, Normal, or Single as the trigger mode. For details, refer to descriptions in *Trigger Mode*.

Trigger Parameter Setting

Sets the trigger parameters (trigger holdoff and noise rejection) under this trigger type. For details, refer to descriptions in *Trigger Holdoff* and *Noise Rejection*.

8.7.9 Window Trigger

Window trigger provides a high trigger level and a low trigger level. The instrument triggers when the input signal passes through the high trigger level or the low trigger level.

Trigger Type

Click or tap the drop-down button of **Type** to select "Window" from the drop-down list. Then set the parameters for Window trigger.

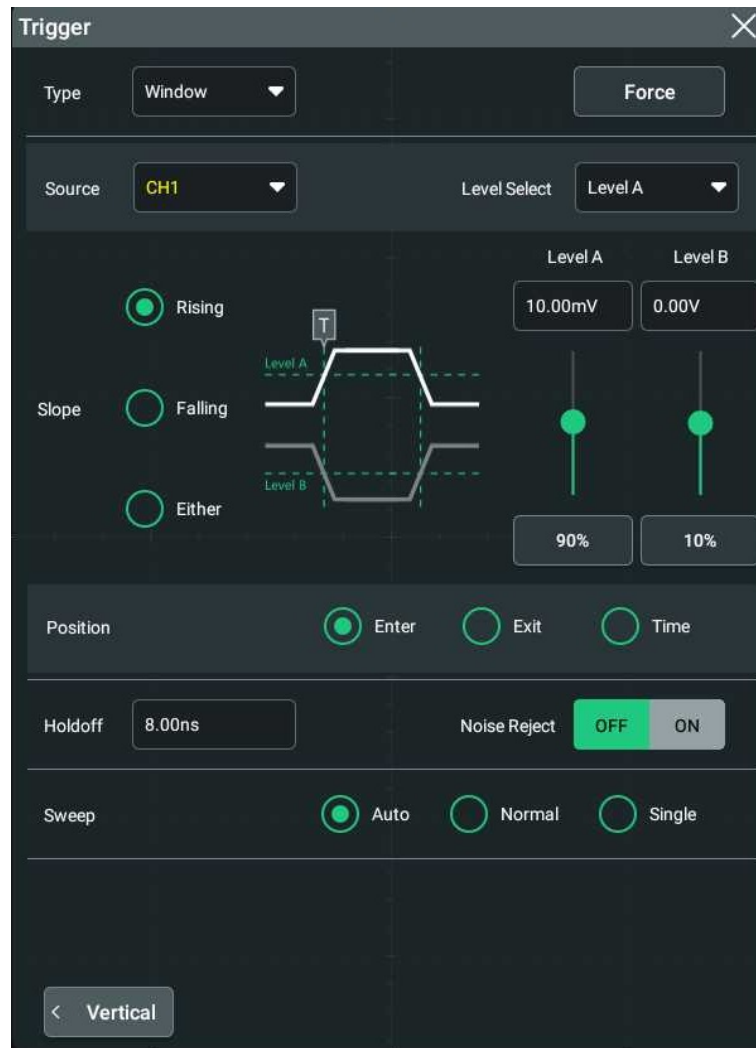
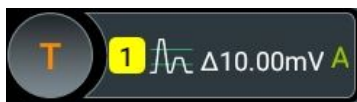

Figure 8.17 Window Trigger Setting Menu

After selecting the trigger type, and then the current trigger setting information (including trigger type, trigger source, and trigger level) is displayed in the trigger information label at the top of the screen, as shown in the figure below. The information will change based on the trigger settings.



Source Selection

Click or tap the drop-down button of **Source** to select CH1-CH4. For details, refer to descriptions in *Trigger Source*. The current trigger source is displayed in the trigger information label at the top of the screen.

Only when we select the channel (that has been input with signals) as the trigger source, can we obtain a stable trigger.

Edge Type

Selects the input signal edge (under the **Slope** menu) on which the oscilloscope triggers.

- **Rising:** triggers on the rising edge of the input signal when the voltage level is higher than the preset high trigger level.
- **Falling:** triggers on the falling edge of the input signal when the voltage level is lower than the preset low trigger level.
- **Either:** triggers on the rising or falling edge of the input signal when the voltage level meets the preset trigger level.

Trigger Position

After selecting the window type, click **Position** to further specify the time point of trigger by selecting the trigger position.

- **Enter:** triggers when the input signal enters the specified trigger level range.
- **Exit:** triggers when the input signal exits the specified trigger level range.
- **Time:** triggers when the accumulated hold time since the input signal entered the specified trigger level range is equal to the window time. After you select this type, click or tap the input field of **Time** to set it by using the pop-up numeric keypad. The available range is from 8 ns to 10 s.

Level Selection and Setting

After the trigger condition setting is completed, you need to adjust the trigger level to correctly trigger the signal and obtain a stable waveform.

Select the level adjustment type under the **Level Select** menu.

- **Level A:** only adjusts the upper limit of the trigger level, and the lower limit of the trigger level remains unchanged.
- **Level B:** only adjusts the lower limit of the trigger level, and the upper limit of the trigger level remains unchanged.
- **Level AB:** adjusts the upper and lower limits of the trigger level at the same time, and the trigger level deviation (the difference between the upper limit and lower limit of the trigger level) remains unchanged.

When setting the trigger level, first select a level type and then tap the "Trigger" icon

on the small screen, rotate the knob  at the upper-right part of the small screen or drag the adjustment icon under the **Level A** and **Level B** menu item to adjust the level of Source A and Source B. For details, refer to descriptions in *Trigger Level*. The current trigger level is displayed in the trigger information label at the top of the screen.

Trigger Mode

In **Sweep** menu, select Auto, Normal, or Single as the trigger mode. For details, refer to descriptions in *Trigger Mode*.

Trigger Parameter Setting

Sets the trigger parameters (trigger holdoff and noise rejection) under this trigger type. For details, refer to descriptions in *Trigger Holdoff* and *Noise Rejection*.

8.7.10 Delay Trigger

In Delay trigger, you need to set Source A and Source B. The oscilloscope triggers when the time difference (ΔT) between the specified edges (Edge A and Edge B) of Source A and Source B meets the preset time limit, as shown in the figure below. Edge A and Edge B must be two neighboring edges.

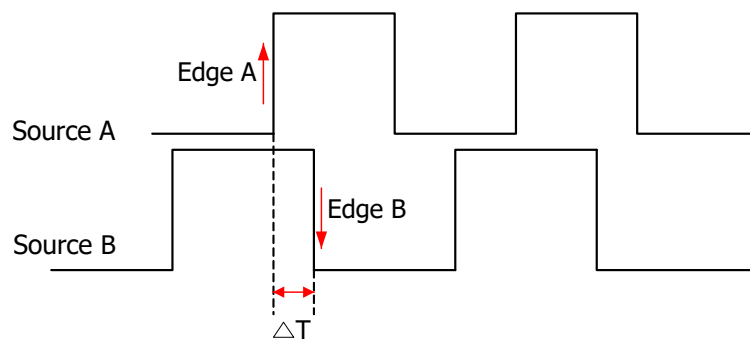

Figure 8.18 Delay Trigger

Trigger Type

Click or tap the drop-down button of **Type** to select "Delay" from the drop-down list. Then set the parameters for Delay trigger.

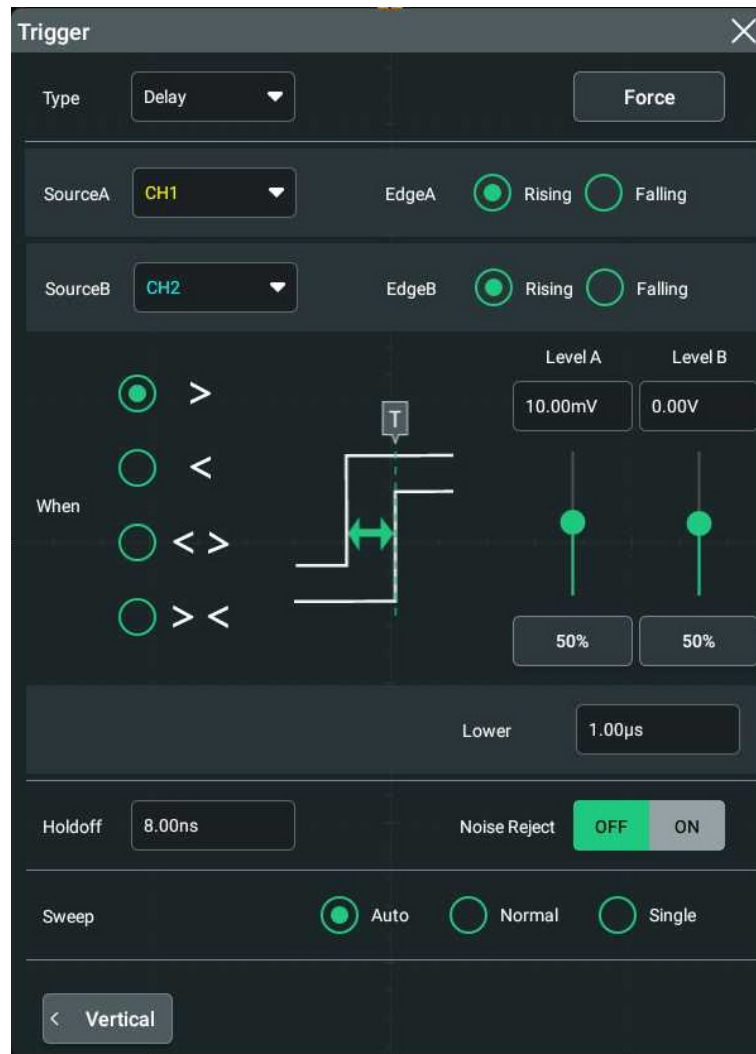

Figure 8.19 Delay Trigger Setting Menu

After selecting the trigger type, and then the current trigger setting information (including trigger type, trigger source, and trigger level) is displayed in the trigger information label at the top of the screen, as shown in the figure below. The information will change based on the trigger settings.



Source Setting

- **Source A:**

Click or tap the drop-down button of **SourceA** to select CH1-CH4. For details, refer to descriptions in *Trigger Source*. The current trigger source is displayed in the trigger information label at the top of the screen.

Only when we select the channel (that has been input with signals) as the trigger source, can we obtain a stable trigger.

- **Edge A:**

Click or tap the trigger edge type ("Rising" or "Falling") of Source A in Delay trigger under the **EdgeA** menu.

- **Source B:**

Click or tap the drop-down button of **SourceB** to select CH1-CH4. For details, refer to descriptions in *Trigger Source*. The current trigger source is displayed in the trigger information label at the top of the screen.

Only when we select the channel (that has been input with signals) as the trigger source, can we obtain a stable trigger.

- **Edge B:**

Click or tap the trigger edge type ("Rising" or "Falling") of Source B in Delay trigger under the **EdgeB** menu.

Set the trigger condition

Sets the time limit condition of Delay trigger in the **When** menu.

- **>**: triggers when the time difference (ΔT) between the specified edges of Source A and Source B is greater than the preset time lower limit. Click or tap the input field of **Lower** to set the delay time lower limit in Delay trigger with the pop-up numeric keypad.
- **<**: triggers when the time difference (ΔT) between the specified edges of Source A and Source B is smaller than the preset time upper limit. Click or tap the input field of **Upper** to set the delay time upper limit in Delay trigger with the pop-up numeric keypad.
- **< >**: triggers when the time difference (ΔT) between the specified edges of Source A and Source B is greater than the lower limit of the preset time and smaller than the upper limit of the preset time. Click or tap the input field of **Upper** to set the delay time upper limit in Delay trigger with the pop-up numeric keypad. Click or tap the input field of **Lower** to set the delay time lower limit in Delay trigger with the pop-up numeric keypad. The lower time limit must be smaller than the upper time limit.
- **> <**: triggers when the time difference (ΔT) between the specified edges of Source A and Source B is smaller than the lower limit of the preset time or greater than the upper limit of the preset time. Click or tap the input field of **Upper** to set the delay time upper limit in Delay trigger with the pop-up numeric keypad. Click or tap the input field of **Lower** to set the delay time lower limit in Delay trigger with the pop-up numeric keypad. The lower time limit must be smaller than the upper time limit.

Level Selection and Setting

After the trigger condition setting is completed, you need to adjust the trigger level to correctly trigger the signal and obtain a stable waveform.

- **Level A:**

Click or tap the input field of **Level A** to input the level of Source A with the pop-up numeric keypad. You can also tap the "Trigger" icon on the small screen, then

rotate the knob  at the upper-right part of the small screen or drag the adjustment icon under the **Level A** menu to adjust the level of Source A. For details, refer to descriptions in *Trigger Level*. The current trigger level is displayed in the trigger information label at the top of the screen.

- **Level B:**

Click or tap the input field of **Level B** to input the level of Source B with the pop-up numeric keypad. You can also tap the "Trigger" icon on the small screen, then

rotate the knob  at the upper-right part of the small screen or drag the adjustment icon under the **Level B** menu to adjust the level of Source B. For details, refer to descriptions in *Trigger Level*. The current trigger level is displayed in the trigger information label at the top of the screen.

Trigger Mode

In **Sweep** menu, select Auto, Normal, or Single as the trigger mode. For details, refer to descriptions in *Trigger Mode*.

Trigger Parameter Setting

Sets the trigger parameters (trigger holdoff and noise rejection) under this trigger type. For details, refer to descriptions in *Trigger Holdoff* and *Noise Rejection*.

8.7.11 Setup/Hold Trigger

In setup&hold trigger, you need to set the clock source and data source. The setup time starts when the data signal passes the trigger level and ends at the coming of the specified clock edge; the hold time starts at the coming of the specified clock edge and ends when the data signal crosses the trigger level again, as shown in the figure below. The oscilloscope triggers when the setup time or hold time is smaller than the preset time.

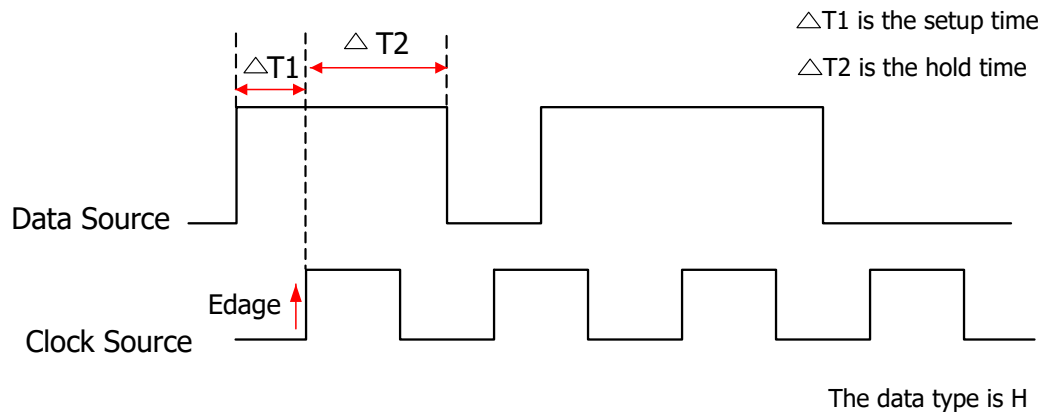
**Figure 8.20 Setup/Hold Trigger****Trigger Type**

Click or tap the drop-down button of **Type** to select "Setup/Hold" from the drop-down list. Then set the parameters for Setup/Hold trigger.

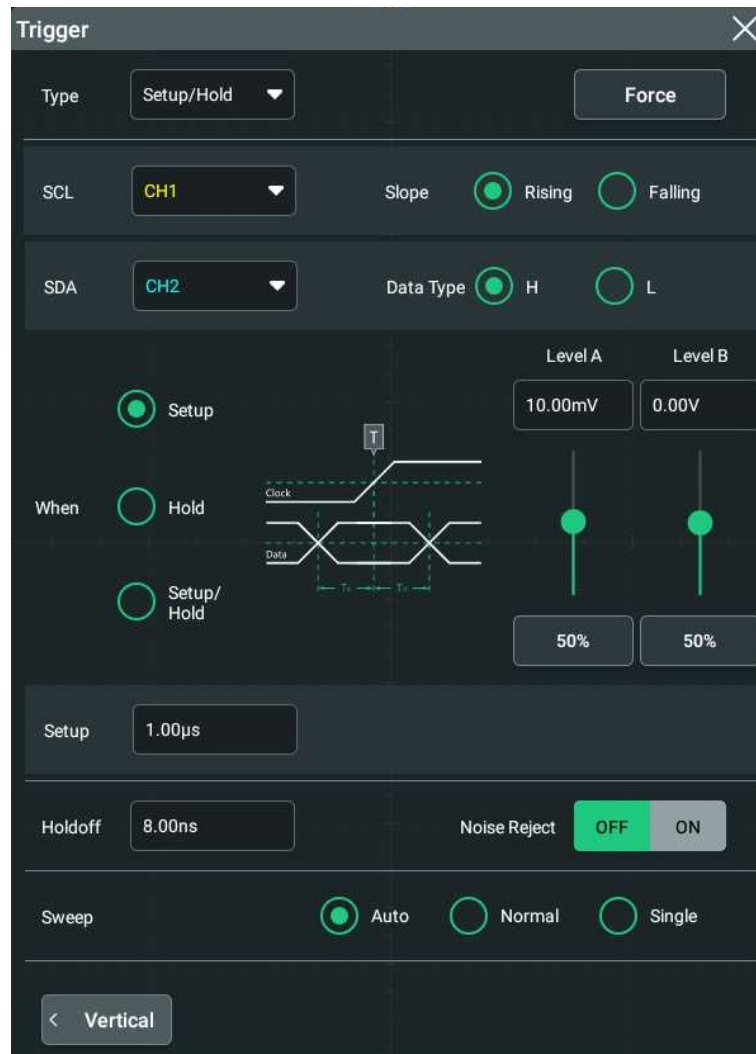

Figure 8.21 Setup/Hold Trigger Setting Menu

After selecting the trigger type, and then the current trigger setting information (including trigger type, trigger source, and trigger level) is displayed at the top of the screen, as shown in the figure below. The information will change based on the trigger settings.



Clock Source

Click or tap the drop-down button of **SCL** to select CH1-CH4. For details, refer to descriptions in *Trigger Source*. The current trigger source is displayed in the trigger information label at the top of the screen.

Only when we select the channel (that has been input with signals) as the trigger source, can we obtain a stable trigger.

Edge Type

Selects the desired clock edge type under the **Slope** menu, and it can be set to "Rising" or "Falling".

Data Source

Click or tap the drop-down button of **SDA** to select CH1-CH4. For details, refer to descriptions in *Trigger Source*. The current trigger source is displayed in the trigger information label at the top of the screen.

Only when we select the channel (that has been input with signals) as the trigger source, can we obtain a stable trigger.

Data Type

Selects the desired item under the **Data Type** menu to set the effective pattern of the data signal. It can be set to H (high level) or L (low level).

Trigger Condition

Sets the Setup/Hold trigger condition in the **When** menu.

- **Setup**: the oscilloscope triggers when the setup time is smaller than the specified setup time. After selecting this type, click or tap the input field of **Setup** to set the setup time with the pop-up numeric keypad.
- **Hold**: the oscilloscope triggers when the hold time is smaller than the specified hold time. After selecting this type, click or tap the input field of **Hold** to set the hold time with the pop-up numeric keypad.
- **Setup/Hold**: the oscilloscope triggers when the setup time or hold time smaller than the specified time value. After selecting this type, click or tap the input field of **Setup** and **Hold** respectively to set the setup and hold time with the pop-up numeric keypad.

Trigger Mode

In **Sweep** menu, select Auto, Normal, or Single as the trigger mode. For details, refer to descriptions in *Trigger Mode*.

Trigger Parameter Setting

Sets the trigger parameters (trigger holdoff and noise rejection) under this trigger type. For details, refer to descriptions in *Trigger Holdoff* and *Noise Rejection*.

Level Selection and Setting

- **Level A**

After the trigger condition setting is completed, you need to adjust the trigger level to correctly trigger the signal and obtain a stable waveform.

Click or tap the input field of **Level A** to input the level of Source A with the pop-up numeric keypad. You can also tap the "Trigger" icon on the small screen, then

rotate the knob  at the upper-right part of the small screen or drag the adjustment icon under the **Level A** menu to adjust the level of the clock source. For details, refer to descriptions in *Trigger Level*. The current trigger level is displayed in the trigger information label at the top of the screen.

- **Level B**

After the trigger condition setting is completed, you need to adjust the trigger level to correctly trigger the signal and obtain a stable waveform.

Click or tap the input field of **Level B** to input the level of data source with the pop-up numeric keypad. You can also tap the "Trigger" icon on the small screen,

then rotate the knob  at the upper-right part of the small screen or drag the adjustment icon under the **Level B** menu to adjust the level of data source. For details, refer to descriptions in *Trigger Level*. The current trigger level is displayed in the trigger information label at the top of the screen.

8.7.12 Nth Edge Trigger

Triggers on the Nth edge that appears after the specified idle time. For example, in the waveform shown in the figure below, the instrument should trigger on the second rising edge after the specified idle time (the time between two neighboring rising edges), and the idle time should be within the range between P and M ($P < \text{Idle Time} < M$). Wherein, M is the time between the first rising edge and its previous rising edge; P is the maximum time between the rising edges that participate in counting.

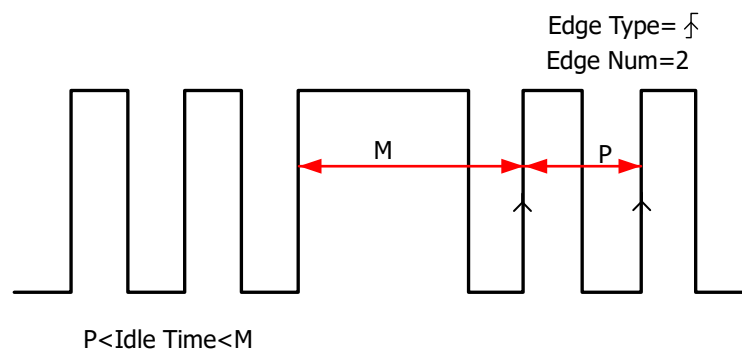

Figure 8.22 Nth Edge Trigger

Trigger Type

Click or tap the drop-down button of **Type** to select "Nth Edge" from the drop-down list. Then set the parameters for Nth Edge trigger.



Figure 8.23 Nth Edge Trigger Setting Menu

After selecting the trigger type, and then the current trigger setting information (including trigger type, trigger source, and trigger level) is displayed in the trigger information label at the top of the screen, as shown in the figure below. The information will change based on the trigger settings.



Source Selection

Click or tap the drop-down button of **Source** to select CH1-CH4. For details, refer to descriptions in *Trigger Source*. The current trigger source is displayed in the trigger information label at the top of the screen.

Only when we select the channel (that has been input with signals) as the trigger source, can we obtain a stable trigger.

Edge Type

Select the input signal edge (under the **Slope** menu) on which the oscilloscope triggers.

- Rising: triggers on the rising edge of the input signal when the voltage level meets the specified trigger level.
- Falling: triggers on the falling edge of the input signal when the voltage level meets the specified trigger level.

Idle Time

Click or tap the input field of **Idle Time**, then use the pop-up numeric keypad to set the idle time before the edge counting in Nth edge trigger.

Edge Count

Click or tap the input field of **Edges**, then use the pop-up numeric keypad to set the value of "N" in Nth edge trigger. The available range is from 1 to 65,535.

Trigger Mode

In **Sweep** menu, select Auto, Normal, or Single as the trigger mode. For details, refer to descriptions in *Trigger Mode*.

Trigger Parameter Setting

Sets the trigger parameter (noise rejection) under this trigger type. For details, refer to descriptions in *Noise Reject*.

Trigger Level

Tap the "Trigger" icon on the small screen, then rotate the knob  at the upper-right part of the small screen or drag the adjustment icon under the **Level** menu to adjust the trigger level. For details, refer to descriptions in *Trigger Level*. The current trigger level is displayed in the trigger information label at the top of the screen.

8.7.13 RS232 Trigger (Option)

RS232 bus is a serial communication mode used in data transmission between PCs or between a PC and a terminal. In RS232 serial protocol, a character is transmitted as a frame of data. The frame consists of 1 start bit, 5-8 data bits, 1 check bit, and 1-2 stop bits. Its format is as shown in the figure below. DS70000 series oscilloscope triggers when the start frame, error frame, check error, or the specified data of the RS232 signal is detected.

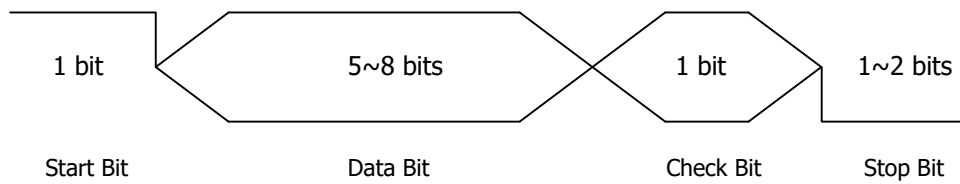

Figure 8.24 Schematic Diagram of RS232 Protocol

Trigger Type

Click or tap the drop-down button of **Type** to select "RS232" from the drop-down list. Then set the parameters for RS232 trigger.

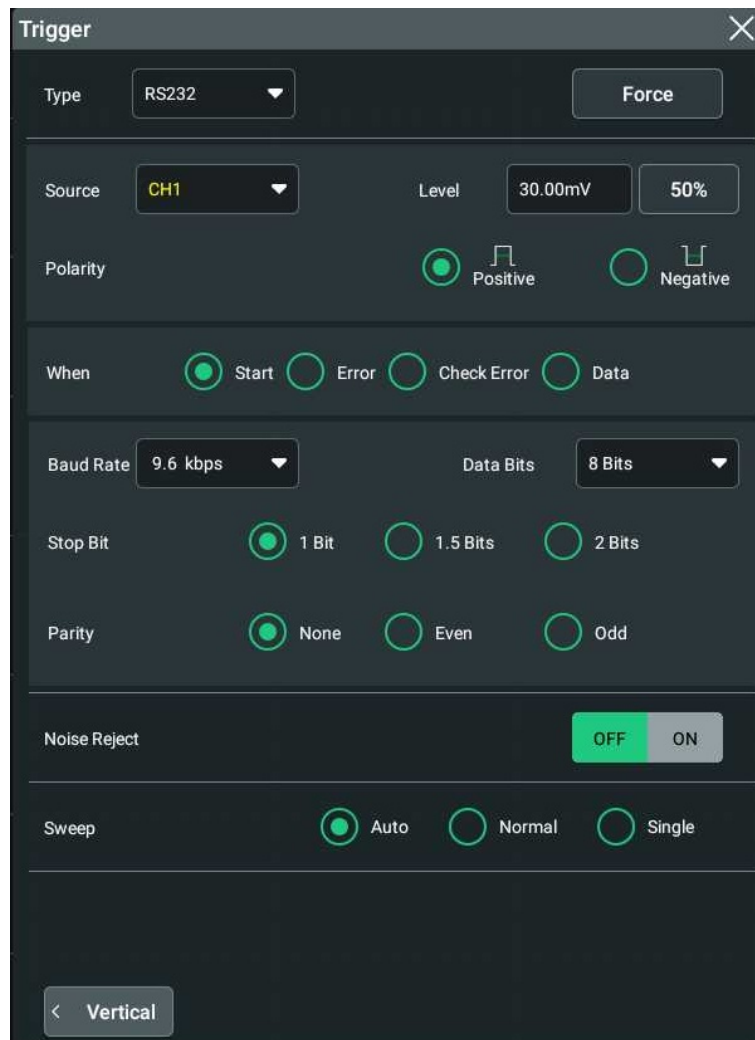
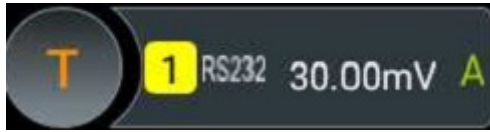

Figure 8.25 RS232 Trigger Setting Menu

After selecting the trigger type, and then the current trigger setting information (including trigger type, trigger source, and trigger level) is displayed at the top of the

screen, as shown in the figure below. The information will change based on the trigger settings.





Source Selection

Click or tap the drop-down button of **Source** to select CH1-CH4. For details, refer to descriptions in *Trigger Source*. The current trigger source is displayed in the trigger information label at the top of the screen.

Only when we select the channel (that has been input with signals) as the trigger source, can we obtain a stable trigger.

Polarity

Selects the polarity of data transmission under the **Polarity** menu. It can be set to "Positive"  or "Negative" .

Trigger Condition

Sets the the desired trigger condition in the **When** menu.

- Start: triggers on the start frame position.
- Error: triggers when an error frame is detected.
- Check Error: triggers when a check error is detected.
- Data: triggers on the last bit of the preset data bits. Click or tap the input field of **Data**, and then use the pop-up numeric keypad to set the data of RS232 trigger.

Baud Rate

Sets the baud rate of data transmission (i.g. specifies a clock frequency). Click or tap the drop-down button of **Baud Rate**, then select the preset baud rate from the drop-down list. The available baud rates include 50 bps, 75 bps, 110 bps, 134 bps, 150 bps, 300 bps, and etc.

Data Bits

Indicate the number of bits per frame. Click or tap the drop-down button of **Data Bits** to select the desired data bits. The available data bits include "5 Bits", "6 Bits", "7 Bits", and "8 Bits".

Stop Bit

Stop Bit: indicates when to stop outputting data. Selects the desired stop bit under the **Stop Bit** menu. The available data bits include 1 Bit, 1.5 Bits, and 2 Bits.

Parity

Used to check whether the data are properly transmitted. Selects None, Even, or Odd under the **Parity** menu.

Trigger Mode

In **Sweep** menu, select Auto, Normal, or Single as the trigger mode. For details, refer to descriptions in *Trigger Mode*.

Trigger Parameter Setting

Sets the trigger parameter (noise rejection) under this trigger type. For details, refer to descriptions in *Noise Reject*.

Trigger Level

Tap the "Trigger" icon on the small screen, then rotate the knob  at the upper-right part of the small screen to adjust the trigger level. You can also set the trigger level with the pop-up numeric keypad. For details, refer to descriptions in *Trigger Level*. The current trigger level is displayed in the trigger information label at the top of the screen.

8.7.14 I2C Trigger (Optional)

I2C is a 2-wire serial bus used to connect the microcontroller and its peripheral device. It is a bus standard widely used in the microelectronic communication control field.

The I2C serial bus consists of SCL and SDA. Its transmission rate is determined by SCL, and its transmission data is determined by SDA, as shown in the figure below. The instrument series triggers on the start condition, restart, stop, missing acknowledgment, specific device address, or data value. Besides, it can also trigger on the specific device address and data values at the same time.

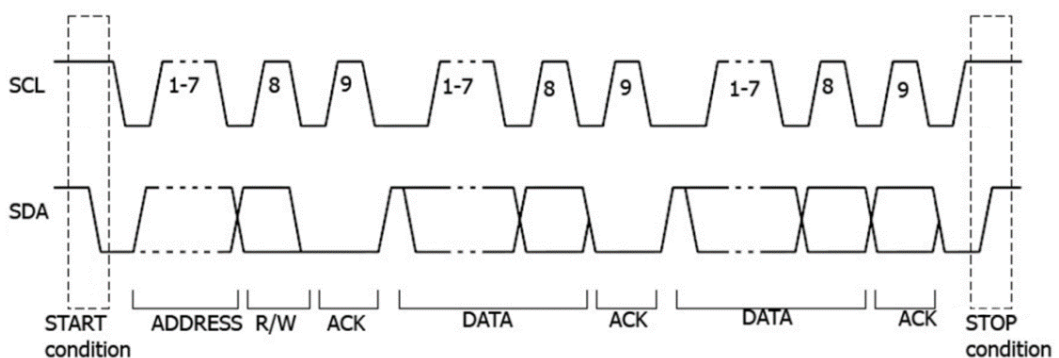

Figure 8.26 Schematic Diagram of I2C Protocol

Trigger Type

Click or tap the drop-down button of **Type** to select "I2C" from the drop-down list. Then set the parameters for I2C trigger.

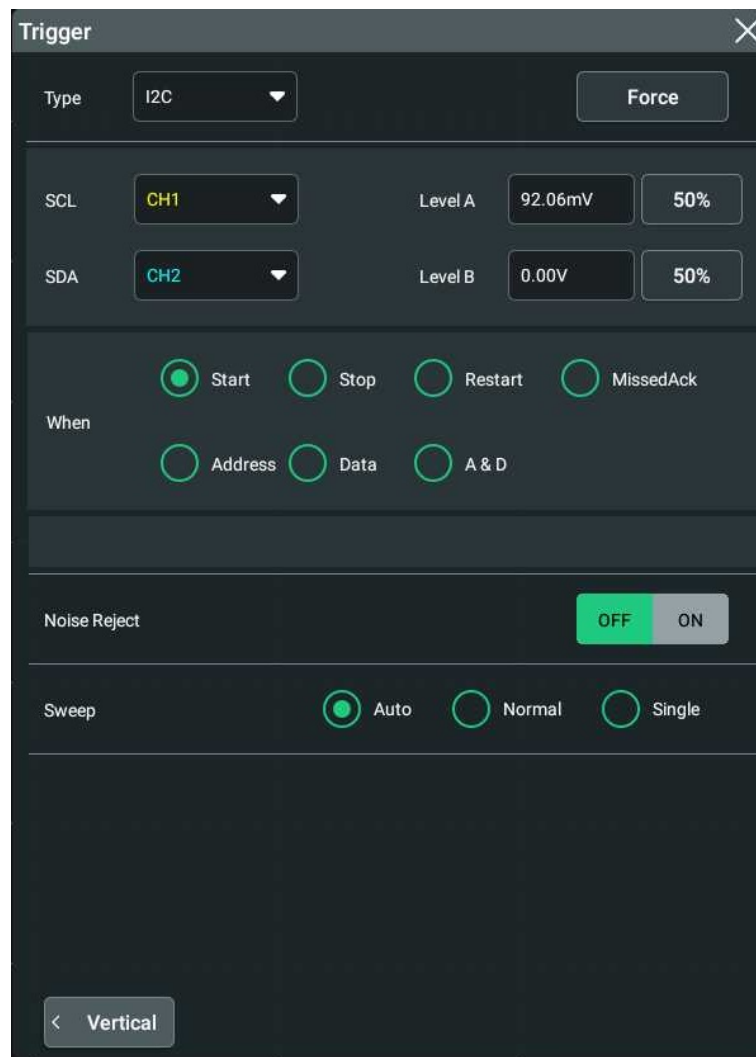

Figure 8.27 I2C Trigger Setting Menu

At this time, the current trigger setting information (including trigger type, trigger source, and trigger level) is displayed at the top of the screen, as shown in the figure below. The information will change based on the trigger settings.



Source Selection

Click or tap the drop-down button of **SCL** and **SDA** to select CH1-CH4 to specify the sources of SCL and SDA respectively. For details, refer to descriptions in *Trigger*

Source. The current trigger source is displayed in the trigger information label at the top of the screen.

Only when we select the channel (that has been input with signals) as the trigger source, can we obtain a stable trigger.

Trigger Condition

Sets the the desired trigger condition in the **When** menu.

- **Start:** triggers when SDA data transitions from high level to low level while SCL is high level.
- **Stop:** triggers when SDA data transitions from low level to high level while SCL is high level.
- **Restart:** triggers when another start condition occurs before a stop condition.
- **MissedAck:** triggers when the SDA data is high level during any acknowledgment of SCL clock position.
- **Address:** the trigger searches for the specified address value. When this event occurs, the oscilloscope will trigger on the read/write bit. After this trigger condition is selected:
 - Click or tap the drop-down button of **Direction** to select "Write", "Read", or "R/W".

This setting is not available when **AddrBits** is set to "8 Bits".
 - Click or tap the drop-down button of **AddrBits** to select the desired address bits. The available address bits are "7 Bits", "8 Bits", and "10 Bits".
 - Click or tap the input field of **Address**, and then use the pop-up numeric keypad to set the address of I2C trigger.
- **Data:** the trigger searches for the specified data value on the data line (SDA). When this event occurs, the oscilloscope will trigger on the clock line (SCL) transition edge of the last bit of data. After this trigger condition is selected, you can set the length of bytes, the address width, and data.
 - Click or tap the input field of **Bytes**, and then use the pop-up numeric keypad to set the length of the data. Its range is from 1 to 5.
 - Click or tap the drop-down button of **AddrBits** to select the desired address bits. The available address bits are "7 Bits", "8 Bits", and "10 Bits".
 - Click or tap the input field of **Data**, and then the "Format" interface is will displayed. As shown in the figure below, you can select "Bin" or "Hex" format to set the data format.

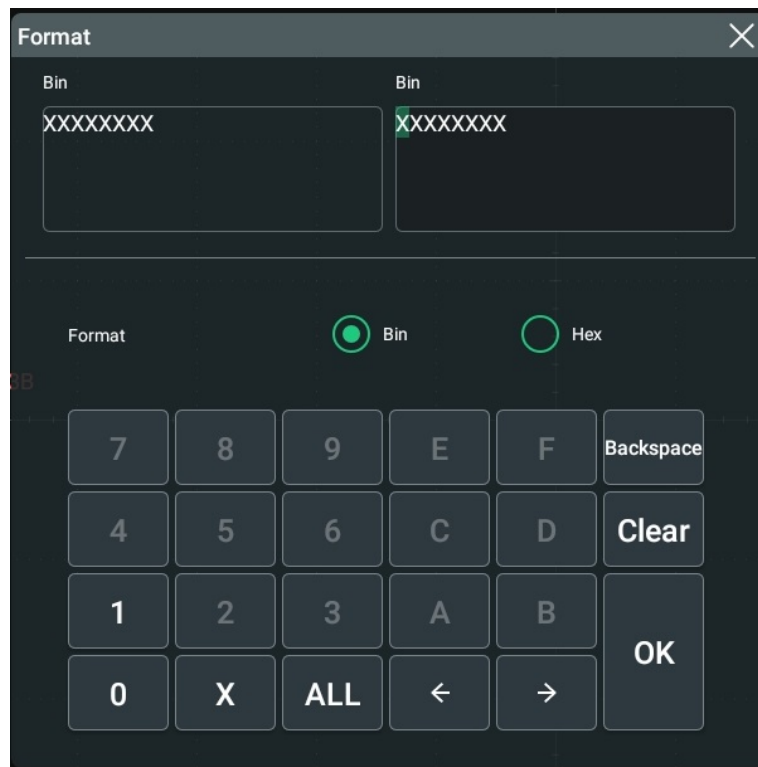

Figure 8.28 Bin Format Setting

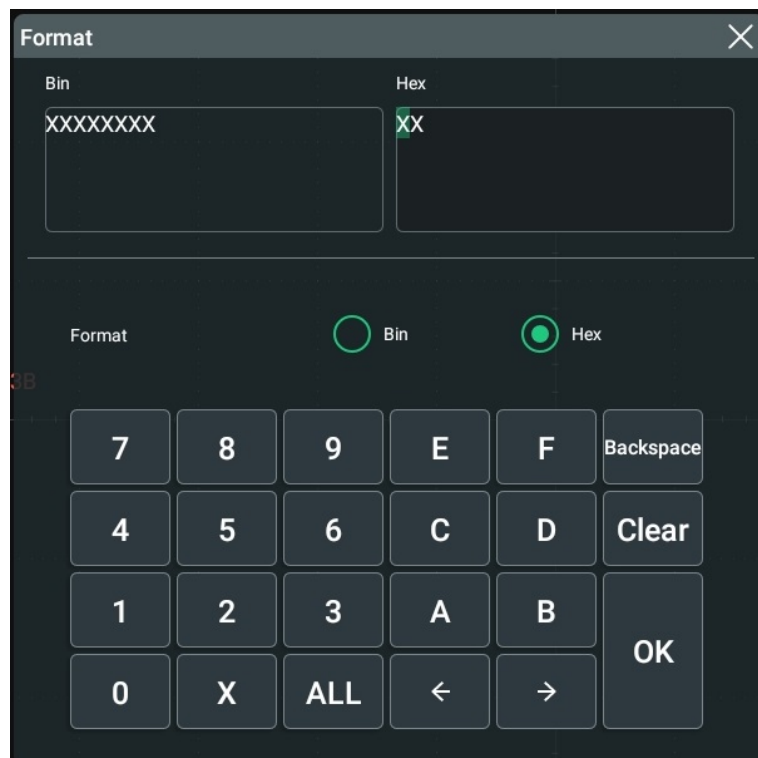

Figure 8.29 Hex Format Setting

- **A&D:** the oscilloscope searches for the specified address and data at the same time, then triggers when both the address and data meet the conditions. After this condition is selected, you need to set the sub-menu items such as **Direction**,

Bytes, **AddrBits**, **Address**, and **Data**. For the setting methods, refer to descriptions in "Address" and "Data" conditions.

Trigger Mode

In **Sweep** menu, select Auto, Normal, or Single as the trigger mode. For details, refer to descriptions in *Trigger Mode*.

Trigger Parameter Setting

Sets the trigger parameter (noise rejection) under this trigger type. For details, refer to descriptions in *Noise Reject*.

Level Selection and Setting

- **Level A**

After the trigger condition setting is completed, you need to adjust the trigger level to correctly trigger the signal and obtain a stable waveform.

Click or tap the input field of **Level A** to input the level of SCL with the pop-up numeric keypad. You can also tap the "Trigger" icon on the small screen, then

rotate the knob  at the upper-right part of the small screen to adjust the level of SCL. For details, refer to descriptions in *Trigger Level*. The current trigger level is displayed in the trigger information label at the top of the screen.

- **Level B**

After the trigger condition setting is completed, you need to adjust the trigger level to correctly trigger the signal and obtain a stable waveform.

Click or tap the input field of **Level B** to input the level of SDA with the pop-up numeric keypad. You can also tap the "Trigger" icon on the small screen, then

rotate the knob  at the upper-right part of the small screen to adjust the level of SDA. For details, refer to descriptions in *Trigger Level*. The current trigger level is displayed in the trigger information label at the top of the screen.

8.7.15 SPI Trigger (Option)

In SPI trigger, after the CS or timeout condition is satisfied, the oscilloscope triggers when the specified data is found. When using SPI trigger, you need to specify the CLK clock sources and MISO data sources.

Below is the sequential chart of SPI bus.

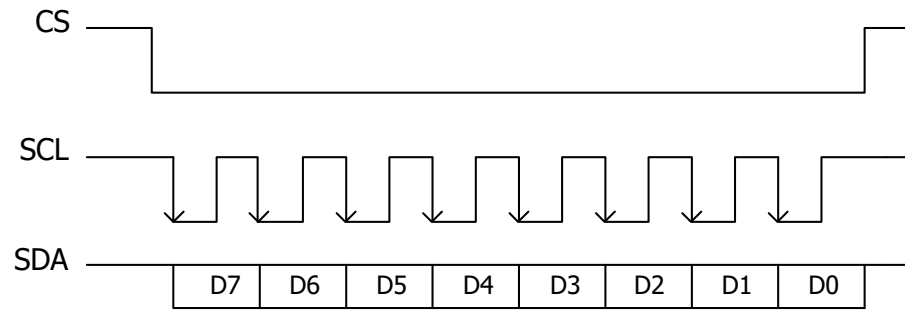

Figure 8.30 Sequential Chart of SPI Bus

Trigger Type

Click or tap the drop-down button of **Type** to select "SPI" from the drop-down list. Then set the parameters for SPI trigger.

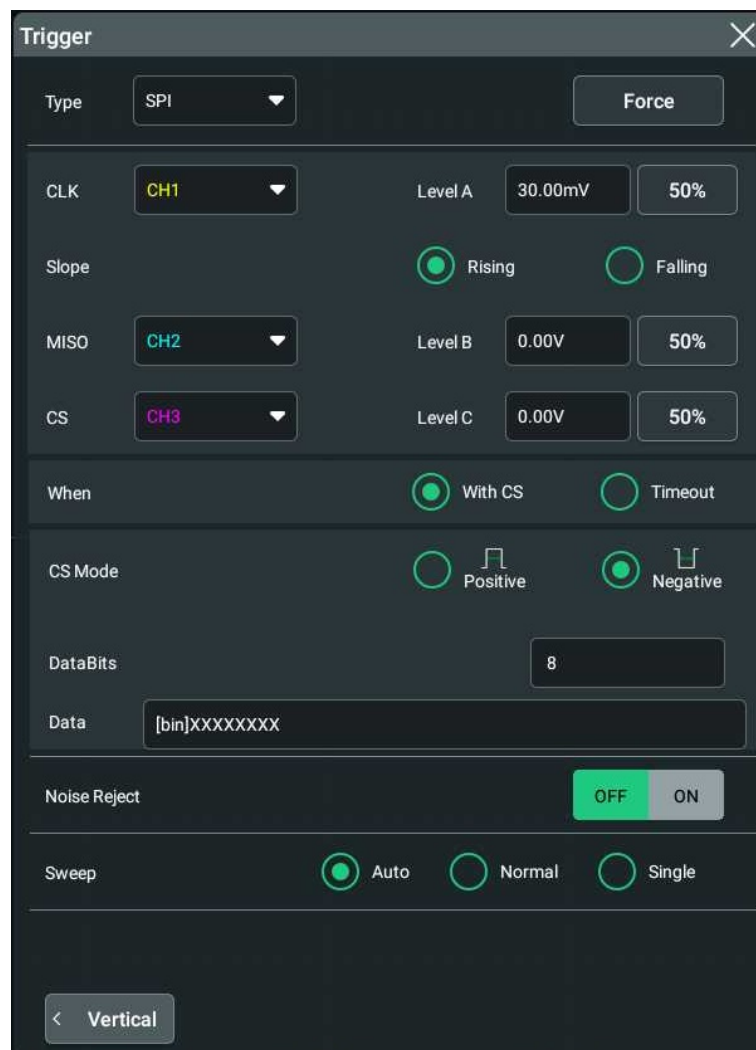

Figure 8.31 SPI Trigger Setting Menu

After selecting the trigger type, and then the current trigger setting information (including trigger type, trigger source, and trigger level) is displayed in the trigger information label at the top of the screen, as shown in the figure below. The information will change based on the trigger settings.



Source Selection

Click or tap the drop-down button of **CLK** and **MISO** to select CH1-CH4 to specify the sources of CLK and MISO respectively. For details, refer to descriptions in *Trigger Source*. The current trigger source is displayed in the trigger information label at the top of the screen.

Only when we select the channel (that has been input with signals) as the trigger source, can we obtain a stable trigger.

Edge Type

Selects the desired clock edge type under **Slope**.

- Rising: samples the MISO data on the rising edge of the clock.
- Falling: samples the MISO data on the falling edge of the clock.

Trigger Condition

Selects the desired trigger condition under **When**.

- With CS: if the CS signal is valid, the oscilloscope will trigger when the data (SDA) satisfying the trigger conditions is found.
 - Click or tap the drop-down button of **CS** to select CH1-CH4 as the CS signal line.
 - After selecting this condition, you can click or tap "Positive" (high level is valid) or "Negative" (low level is valid) under **CS Mode**.
- Timeout: the oscilloscope starts to search for the data (MISO) on which to trigger after the clock signal (CLK) stays in the idle state for a specified period of time. After selecting this condition, you can click or tap **Timeout**, then use the numeric keypad to set the idle time. The range is from 8 ns to 10 s.

Data

Click or tap the of field of **Data**, and then the "Format" interface is will displayed. You can set the data bit that needs to be operated on. For details, refer to descriptions in *I2C Trigger (Option)*.

Data Bits

Click or tap the input field of **DataBits**, and then use the pop-up numeric keypad to set the number of bits in the serial data string. The number of bits in the string can be set to any integer ranging from 4 to 32.

Trigger Mode

In **Sweep** menu, select Auto, Normal, or Single as the trigger mode. For details, refer to descriptions in *Trigger Mode*.

Trigger Parameter Setting

Sets the trigger parameter (noise rejection) under this trigger type. For details, refer to descriptions in *Noise Reject*.

Level Selection and Setting

- **Level A**

After the trigger condition setting is completed, you need to adjust the trigger level to correctly trigger the signal and obtain a stable waveform.

Click or tap the input field of **Level A** to input the level of CLK with the pop-up numeric keypad. You can also tap the "Trigger" icon on the small screen, then

rotate the knob  at the upper-right part of the small screen to adjust the level of CLK. For details, refer to descriptions in *Trigger Level*. The current trigger level is displayed in the trigger information label at the top of the screen.

- **Level B**

After the trigger condition setting is completed, you need to adjust the trigger level to correctly trigger the signal and obtain a stable waveform.

Click or tap the input field of **Level B** to input the level of MISO with the pop-up numeric keypad. You can also tap the "Trigger" icon on the small screen, then

rotate the knob  at the upper-right part of the small screen to adjust the level of MISO. For details, refer to descriptions in *Trigger Level*. The current trigger level is displayed in the trigger information label at the top of the screen.

- **Level C**

After the trigger condition setting is completed, you need to adjust the trigger level to correctly trigger the signal and obtain a stable waveform.

Click or tap the input field of **Level C** to input the level of CS with the pop-up numeric keypad. You can also tap the "Trigger" icon on the small screen, then

rotate the knob  at the upper-right part of the small screen to adjust the level of CS. For details, refer to descriptions in *Trigger Level*. The current trigger level is displayed in the trigger information label at the top of the screen.

8.7.16 CAN Trigger (Option)

DS70000 can trigger on the start of a frame, end of a frame, frame of the specified type (e.g. Remote, Overload, Data, etc.), or error frame of the specified type (e.g. Answer Error, Check Error, Format Error, etc.) of the CAN signal.

The data frame format of the CAN bus is as shown in the figure below.

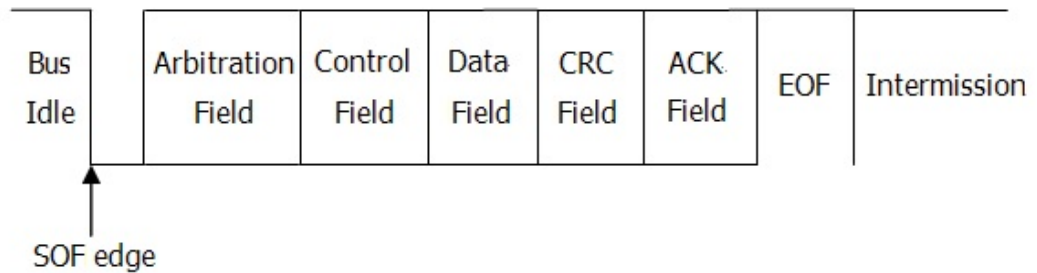

Figure 8.32 Data Frame Format of the CAN Bus

Trigger Type

Click or tap the drop-down button of **Type** to select "CAN" from the drop-down list. Then set the parameters for CAN trigger.

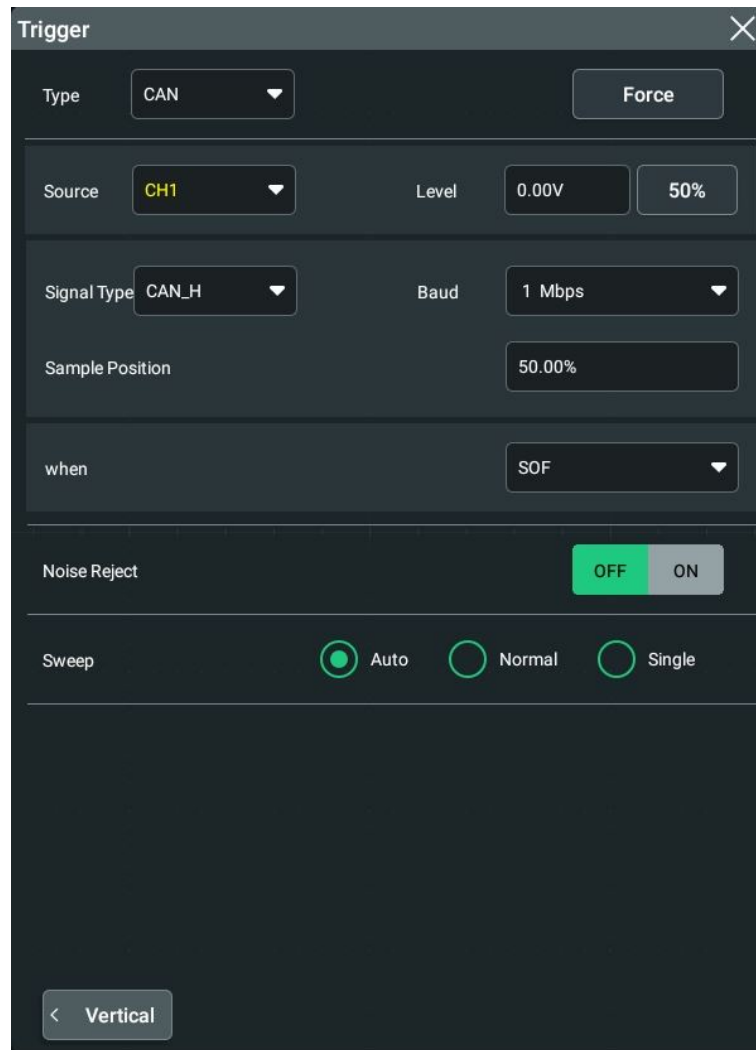
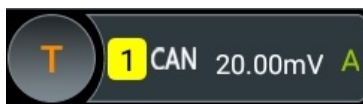

Figure 8.33 CAN Trigger Setting Menu

After selecting the trigger type, and then the current trigger setting information (including trigger type, trigger source, and trigger level) is displayed in the trigger information label at the top of the screen, as shown in the figure below. The information will change based on the trigger settings.



Source Selection

Click or tap the drop-down button of **Source** to select CH1-CH4. For details, refer to descriptions in *Trigger Source*. The current trigger source is displayed in the trigger information label at the top of the screen.

Only when we select the channel (that has been input with signals) as the trigger source, can we obtain a stable trigger.

Signal Type

Click or tap the drop-down button of **Signal Type** to select the desired signal type.

- CAN_H: indicates the actual CAN_H bus signal.
- CAN_L: indicates the actual CAN_L bus signal.
- TX/RX: indicates the Transmit signal and Receive signal from the CAN bus transceiver.
- DIFF: indicates the CAN differential bus signals connected to an analog channel by using a differential probe. Connect the probe's positive lead to the CAN_H bus signal and connect the negative lead to the CAN_L bus signal.

Baud Rate

Set the baud rate of the signal. Click or tap the drop-down button of **Baud** to select the preset baud rate from the drop-down list. The available baud rates include 10 kbps, 20 kbps, 33.3 kbps, 50 kbps, 62.5 kbps, 83.3 kbps, and etc.

Sample Position

Sample position is a point within a bit's time. The oscilloscope samples the bit level at this point. The sample position is represented by the proportion of "the time from the start of the bit to the sample position" to the "bit time", as shown in the figure below.

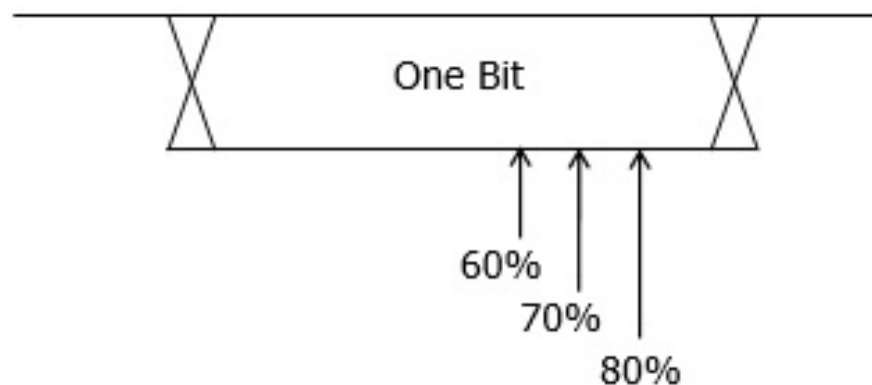

Figure 8.34 Sample Position

Click or tap the input field of **Sample Position** to set it by using the pop-up numeric keypad. The settable range is from 10% to 90%.

Trigger Condition

Click or tap the drop-down button of **When** to select the desired trigger condition.

- SOF: triggers at the start of a frame.

- EOF: triggers at the end of a frame.
- Remote ID: triggers on the specified ID of Remote frame. When you select **Remote ID**, you need to set the following parameters.
 - Click or tap the ON/OFF tab for the **Extended ID** menu to enable or disable the extended ID.
 - Click or tap the input field of **Data**, and then the "Format" interface is displayed. You can set the data bit that needs to be operated on. For details, refer to descriptions in *I2C Trigger (Option)*.
- Overload: triggers on the overload frames.
- Frame ID: triggers on the data frames with the specified ID. When you select **Frame ID**, you need to set the following parameters.
 - Click or tap the ON/OFF tab for the **Extended ID** menu to enable or disable the extended ID.
 - Click or tap the input field of **Data**, and then the "Format" interface is displayed. You can set the data bit that needs to be operated on. For details, refer to descriptions in *I2C Trigger (Option)*.
- Frame Data: triggers on the data frames with the specified Data. When you select **Frame Data**, you need to set the following parameters.

Click or tap the input field of **Data**, and then the "Format" interface is displayed. You can set the data bit that needs to be operated on. For details, refer to descriptions in *I2C Trigger (Option)*.
- Data & ID: triggers on the data frames with the specified ID and data. When you select **Data & ID**, click or tap to select "Data" or "ID" under the **Define** menu. When you select "Data", click or tap the input field of **Data**, and then the "Format" interface is displayed. You can set the data bit that needs to be operated on. For details, refer to descriptions in *I2C Trigger (Option)*. When you select "ID", you need to set the following parameters.
 - Click or tap the ON/OFF tab for the **Extended ID** menu to enable or disable the extended ID.
 - Click or tap the input field of **Data**, and then the "Format" interface is displayed. You can set the data bit that needs to be operated on. For details, refer to descriptions in *I2C Trigger (Option)*.
- Frame Error: triggers on the error frame.
- Bit Fill: triggers on the error frame with the bit fill.
- Answer Error: triggers on the answer error frame.
- Check Error: triggers on the check error frame.
- Format Error: triggers on the format error frame.

- Random Error: triggers on the random error frame, such as the format error frame, answer error frame, etc.

Trigger Mode

In **Sweep** menu, select Auto, Normal, or Single as the trigger mode. For details, refer to descriptions in *Trigger Mode*.

Trigger Parameter Setting

Sets the trigger parameter (noise rejection) under this trigger type. For details, refer to descriptions in *Noise Reject*.

Trigger Level

Tap the "Trigger" icon on the small screen, then rotate the knob  at the upper-right part of the small screen to adjust the trigger level. You can also set the trigger level with the pop-up numeric keypad. For details, refer to descriptions in *Trigger Level*. The current trigger level is displayed in the trigger information label at the top of the screen.

8.7.17 FlexRay Trigger (Option)

DS70000 can trigger on the specified frame, symbol, error, or position of the FlexRay bus. FlexRay is a type of differential serial bus configured with three consecutive segments (i.g. packet header, payload, and packet trailer). Its data transmission rate is up to 10 Mb/s. Each frame contains a static segment and a dynamic segment, and ends with the bus idle time.

Its format is as shown in the figure below.

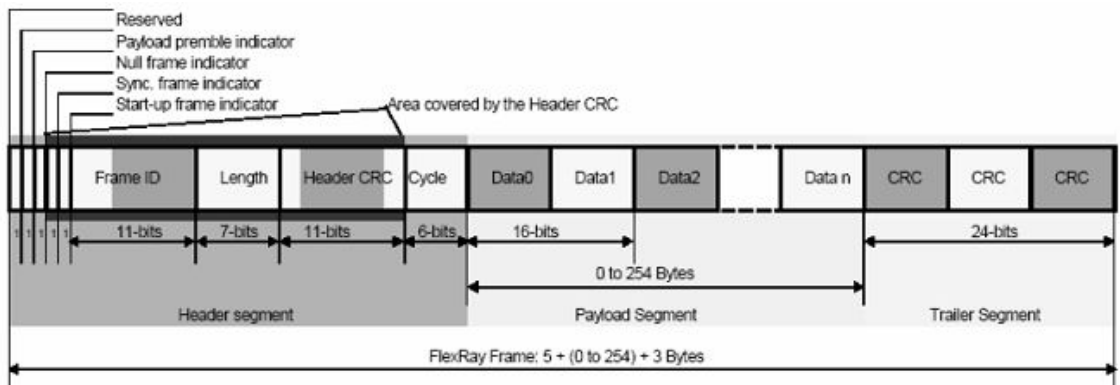

Figure 8.35 Frame Format of FlexRay Bus

Trigger Type

Click or tap the drop-down button of **Type** to select "FlexRay" from the drop-down list. Then set the parameters for FlexRay trigger.

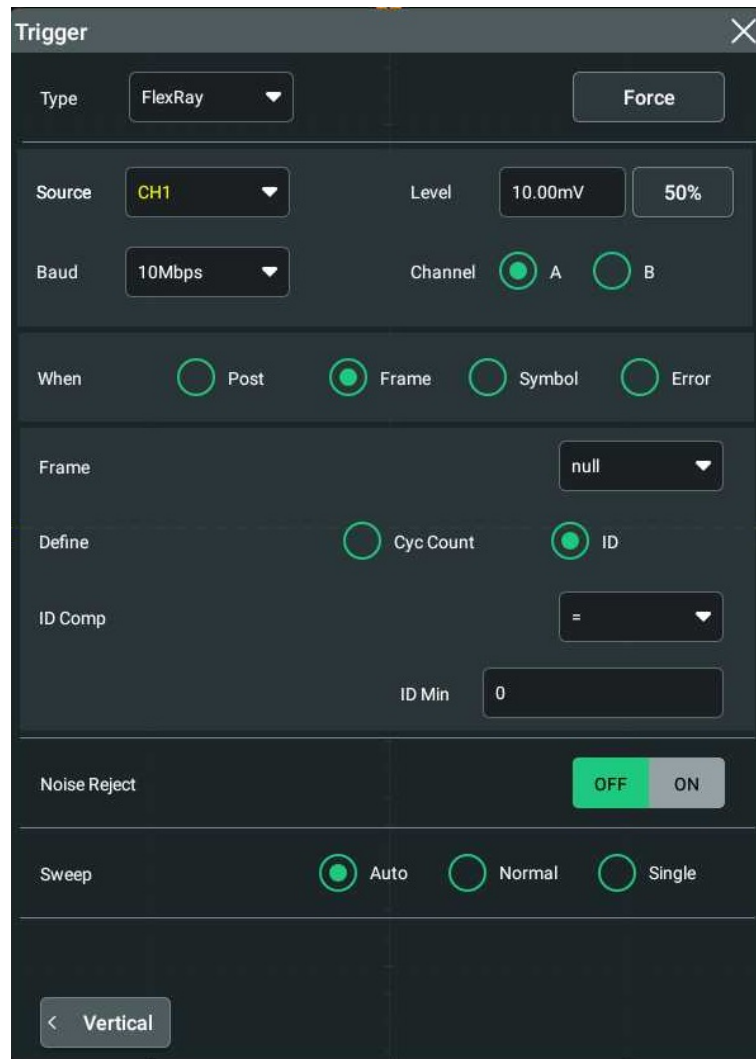
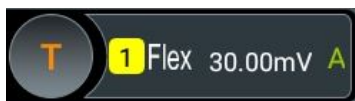

Figure 8.36 FlexRay Trigger Setting Menu

After selecting the trigger type, and then the current trigger setting information (including trigger type, trigger source, and trigger level) is displayed in the trigger information label at the top of the screen, as shown in the figure below. The information will change based on the trigger settings.



Source Selection

Click or tap the drop-down button of **Source** to select CH1-CH4. For details, refer to descriptions in *Trigger Source*. The current trigger source is displayed in the trigger information label at the top of the screen.

Only when we select the channel (that has been input with signals) as the trigger source, can we obtain a stable trigger.

Baud Rate

Set the baud rate of the signal. Click or tap the drop-down button **Baud** to select a FlexRay baud rate that matches the FlexRay bus signal. Select the preset baud rate from the drop-down list. The available baud rates include 2.5 Mbps, 5 Mbps, and 10 Mbps.

Trigger Condition

Click or tap the drop-down button of **When** to select the desired trigger condition.

- Post: triggers on the specified position of the FlexRay bus. Select **Post** as the trigger condition, and then click or tap its drop-down button to select "TSS End", "FSS_BSS End", "FES End", or "DTS End" from the drop-down list.
- Frame: triggers on the frame of FlexRay bus.

- Click or tap the drop-down button of **Frame** to select the frame type. The types of frames include null, Syns, Start, and All.

- Select "ID" or "Cyc Count" under the **Define** menu.

When you select "Cyc Count", set the following parameters: Cyc Comp, Count Min, and Count Max. Click or tap the drop-down button of **Cyc Comp** to select the comparison conditions. The available choices include =, ≠, >, <, ><, and <>. When a certain condition is selected, click or tap the input field of **Count Min** or **Count Max**, then set the number of cycles with the pop-up numeric keypad.

When you select "ID", set the following parameters: ID Comp, ID Min, and ID Max. Click or tap the drop-down button of **ID Comp** to select the comparison conditions. The available choices include =, ≠, >, <, ><, and <>. When a certain condition is selected, click or tap the input field of **ID Max** or **ID Min**, then use the numeric keypad to set the frame ID.

- Symbol: triggers on the CAS/MTS (Collision Avoidance Symbol/Media Access Test Symbol) and WUP (Wakeup Pattern) of FlexRay bus.
 - Click or tap the drop-down button of **Symbol** to select the symbol type. The symbol type includes CAS/MTS and WUS.
 - Click or tap the drop-down button of **ID Comp** to select the comparison conditions. The available choices include =, ≠, >, <, ><, and <>. When a certain condition is selected, click or tap the input field of **ID Max** or **ID Min**, then use the numeric keypad to set the frame ID.
- Error: triggers when an error occurs to the FlexRay bus. Click or tap the drop-down button of **Error** to select the error type. It includes Head CRC Err, Tail CRC Err, Decode Err, and Random Err.

As the occurrence possibility of specified FlexRay frame is very low, it is recommended that you set the oscilloscope to "Normal" trigger mode when the

trigger condition is set to "Frame", so as to prevent the instrument from triggering automatically while waiting for the specified frame. The same goes for "Error" trigger condition. In addition, when multiple FlexRay errors occur at the same time, you need to adjust the trigger holdoff so as to view the specific error.

Trigger Mode

In **Sweep** menu, select Auto, Normal, or Single as the trigger mode. For details, refer to descriptions in *Trigger Mode*.

Trigger Parameter Setting

Sets the trigger parameter (noise rejection) under this trigger type. For details, refer to descriptions in *Noise Reject*.

Trigger Level

Tap the "Trigger" icon on the small screen, then rotate the knob  at the upper-right part of the small screen to adjust the trigger level. You can also set the trigger level with the pop-up numeric keypad. For details, refer to descriptions in *Trigger Level*. The current trigger level is displayed in the trigger information label at the top of the screen.

8.7.18 LIN Trigger (Option)

DS70000 can trigger on the sync field of LIN signal, and can also trigger on the specified identifier, data, or frame.

The data frame format of the LIN bus is as shown in the figure below.

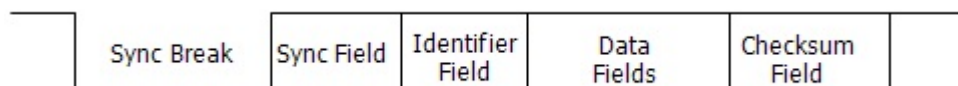

Figure 8.37 Data Frame Format of the LIN Bus

Trigger Type

Click or tap the drop-down button of **Type** to select "LIN" from the drop-down list. Then set the parameters for LIN trigger.

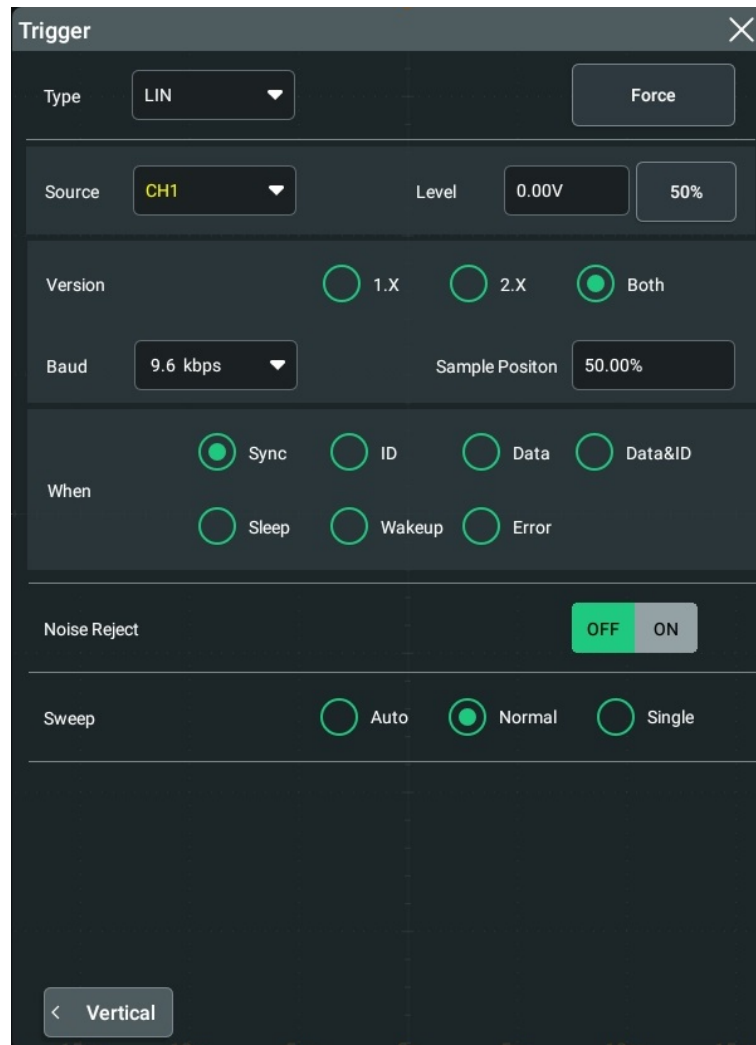

Figure 8.38 LIN Trigger Setting Menu

After selecting the trigger type, then the current trigger setting information (including trigger type, trigger source, and trigger level) is displayed in the trigger information label at the top of the screen, as shown in the figure below. The information will change based on the trigger settings.



Source Selection

Click or tap the drop-down button of **Source** to select CH1-CH4. For details, refer to descriptions in *Trigger Source*. The current trigger source is displayed in the trigger information label at the top of the screen.

Only when we select the channel (that has been input with signals) as the trigger source, can we obtain a stable trigger.

Protocol Version

In the **Version** menu, select the protocol version that matches the signal under test. The available versions include 1.X, 2.X and Both.

Baud Rate

Click or tap the drop-down button of the **Baud** menu to select the preset baud rate from the drop-down list. The available baud rates include 1.2 kbps, 2.4 kbps, 4.8 kbps, 9.6 kbps, 19.2 kbps, and etc.

Sample Position

Sample position is a point within a bit's time. The oscilloscope samples the bit level at this point. The sample position is represented by the proportion of "the time from the start of the bit to the sample position" to the "bit time", as shown in the figure below.

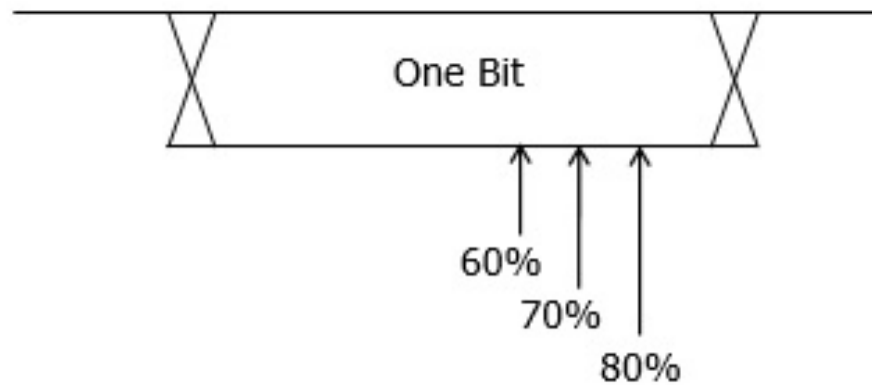

Figure 8.39 Sample Position

Click or tap the input field of **Sample Position** to set it by using the pop-up numeric keypad. The settable range is from 10% to 90%.

Trigger Condition

Click or tap the drop-down button of **When** to select the desired trigger condition.

- **Sync:** triggers on the last bit of the sync field.
- **ID:** triggers when the frames with the specified ID are found.

Click or tap the input field of **ID**, and then use the pop-up numeric keypad to set ID.

- **Data:** triggers when the data that meet the preset conditions are found.
 - Click or tap the input field of **Bytes**, and then use the pop-up numeric keypad to set the length of the data. Its range is from 1 to 8.

- Click or tap the input field of **Data**, and then the "Format" interface is displayed. You can set the data bit that needs to be operated on. For details, refer to descriptions in *I2C Trigger (Option)*.
- **Data&ID**: triggers when the frames with the specified ID and data that meet the preset conditions are both found.
 - Click or tap the input field of **Bytes**, and then use the pop-up numeric keypad to set the length of the data. Its range is from 1 to 8.
 - Click or tap the input field of **ID**, and then use the pop-up numeric keypad to set ID.
 - Click or tap the input field of **Data**, and then the "Format" interface is displayed. You can set the data bit that needs to be operated on. For details, refer to descriptions in *I2C Trigger (Option)*.
- **Sleep**: triggers when the sleep frame is found.
- **Wakeup**: triggers when the wakeup frame is found.
- **Error**: triggers on the specified type of error frame. Click or tap the drop-down button of **Error Type** to select the error type: Sync, Even Odd, or Check Sum.

Trigger Mode

In **Sweep** menu, select Auto, Normal, or Single as the trigger mode. For details, refer to descriptions in *Trigger Mode*.

Trigger Parameter Setting

Sets the trigger parameter (noise rejection) under this trigger type. For details, refer to descriptions in *Noise Reject*.

Trigger Level

Tap the "Trigger" icon on the small screen, then rotate the knob  at the upper-right part of the small screen to adjust the trigger level. You can also set the trigger level with the pop-up numeric keypad. For details, refer to descriptions in *Trigger Level*. The current trigger level is displayed in the trigger information label at the top of the screen.

8.7.19 I2S Trigger (Option)

In I2S trigger, the oscilloscope searches for the specified data value and take it as the condition for identifying the trigger. You need to specify the serial clock line (SCLK, 1 pulse is found on the clock line once 1 bit of digital audio data is sent), frame clock line (WS, used for switch the audio channel data), and serial data line (SDA, used for transmit audio data represented in binary (2's complement)).

Below is the sequential chart of I2S bus.

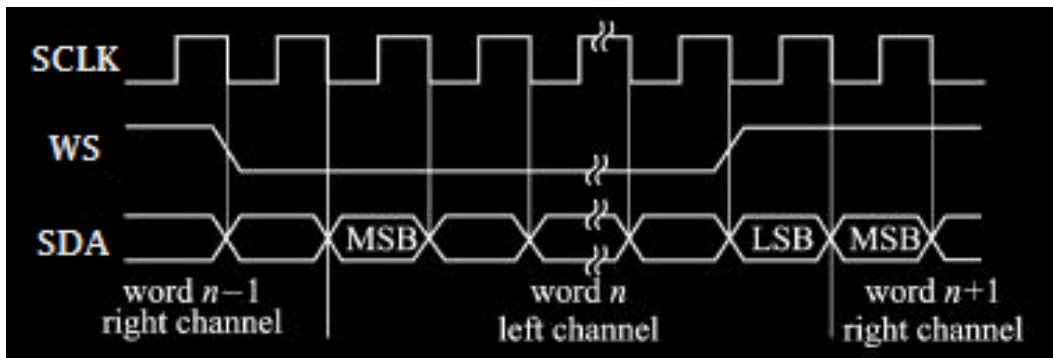

Figure 8.40 Sequential Chart of I2S Bus

Trigger Type

Click or tap the drop-down button of **Type** to select "I2S" from the drop-down list. Then set the parameters for I2S trigger.

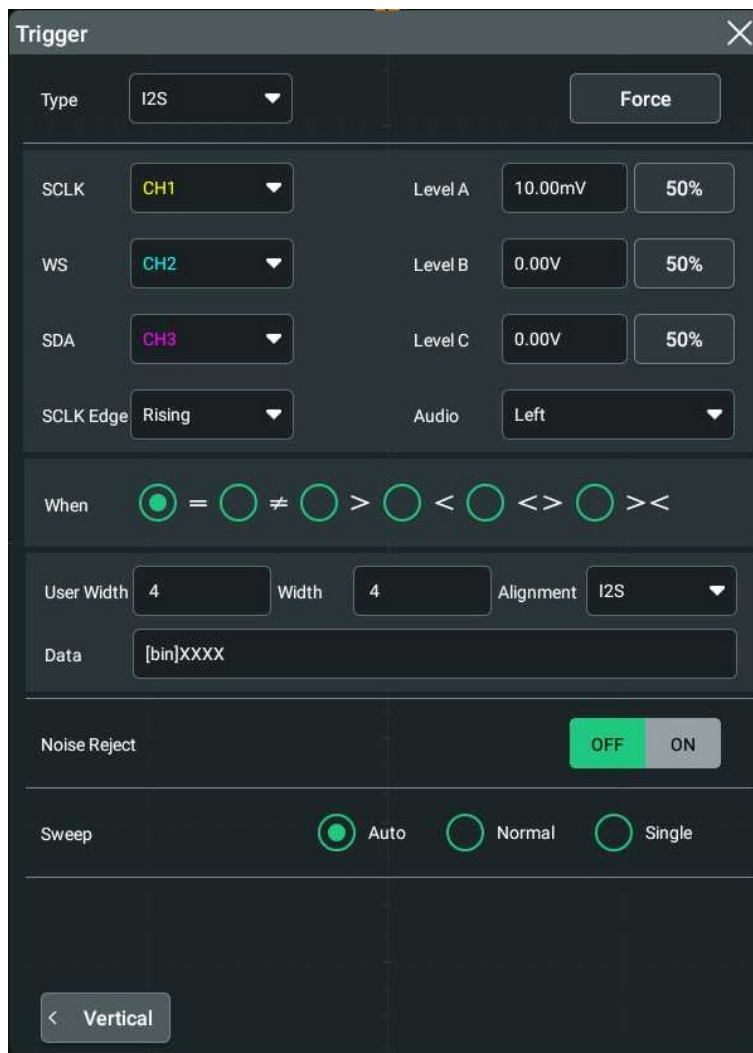

Figure 8.41 I2S Trigger Setting Menu

After selecting the trigger type, then the current trigger setting information (including trigger type, trigger source, and trigger level) is displayed in the trigger information label at the top of the screen, as shown in the figure below. The information will change based on the trigger settings.



Source Selection

Click or tap the drop-down button of **SCLK**, **WS**, and **SDA** to select CH1-CH4 to the specify the sources of SCLK, WS, and SDA respectively. For details, refer to descriptions in *Trigger Source*. The current trigger source is displayed in the trigger information label at the top of the screen.

Only when we select the channel (that has been input with signals) as the trigger source, can we obtain a stable trigger.

Edge Type

Selects the desired clock edge from the drop-down list of **SCLK Edge**.

- Rising: samples the SDA data on the rising edge of the clock.
- Falling: samples the SDA data on the falling edge of the clock.

Audio

Click or tap the drop-down button of **Audio** to select the audio channel ("Left", "Right", or "Either").

Trigger Condition

Click or tap the drop-down button of **When** to select the desired trigger condition.

- =: triggers when the channel's data equal the set data value. Click or tap the input field of **Data**, and then the "Format" interface is displayed. You can set the data bit that needs to be operated on. For details, refer to descriptions in *I2C Trigger (Option)*.
- ≠: triggers when the channel's data do not equal the set data value. Click or tap the input field of **Data**, and then the "Format" interface is displayed. You can set the data bit that needs to be operated on. For details, refer to descriptions in *I2C Trigger (Option)*.
- >: triggers when the channel's data are greater than the set data value. Click or tap the input field of **Data Min**, and then the "Format" interface is displayed. You can set the lower limit of the data bit. For details, refer to descriptions in *I2C Trigger (Option)*.

- **<:** triggers on when the channel's data are smaller than the set data value. Click or tap the input field of **Data Max**, and then the "Format" interface is displayed. You can set the upper limit of the data bit. For details, refer to descriptions in *I2C Trigger (Option)*.
- **< >:** triggers when the channel's data are smaller than the upper limit of the data value and greater than the lower limit of the data value.. Click or tap the input field of **Data Max** and **Data Min**, and then the "Format" interface is displayed. You can set the upper limit and lower limit of the data bit. For details, refer to descriptions in *I2C Trigger (Option)*.
- **> <:** triggers when the channel's data are greater than the upper limit of the data value and smaller than the lower limit of the data value. Click or tap the input field of **Data Max** and **Data Min**, and then the "Format" interface is displayed. You can set the upper limit and lower limit of the data bit. For details, refer to descriptions in *I2C Trigger (Option)*.

User Width

Click or tap the input field of **User Width** to set it by using the pop-up numeric keypad. Its range is from 4 to 32.

The user width is smaller than or equal to the width.

Width

Click or tap the input field of **Width** to set it by using the pop-up numeric keypad. Its range is from 4 to 32.

Alignment

Click or tap the drop-down button of **Alignment** to select the alignment way for data signal.

- **I2S:** MSB (Most Significant Bit) of data for each sample is sent first, and LSB (Least Significant Bit) is sent last. The MSB appears on the SDA line one bit clock after the edge of the WS transition.
- **LJ:** data transmission (MSB first) begins at the edge of the WS transition.
- **RJ:** data transmission (MSB first) is right-justified to the WS transition.

Trigger Mode

In **Sweep** menu, select Auto, Normal, or Single as the trigger mode. For details, refer to descriptions in *Trigger Mode*.

Trigger Parameter Setting

Sets the trigger parameter (noise rejection) under this trigger type. For details, refer to descriptions in *Noise Reject*.

Trigger Level

- **Level A**

Sets the trigger level of SCLK. Tap the "Trigger" icon on the small screen, then rotate the knob  at the upper-right part of the small screen to adjust the trigger level. You can also set the trigger level with the pop-up numeric keypad. For details, refer to descriptions in [Trigger Level](#). The current trigger level is displayed in the trigger information label at the top of the screen.

- **Level B**

Sets the trigger level of WS. Tap the "Trigger" icon on the small screen, then rotate the knob  at the upper-right part of the small screen to adjust the trigger level. You can also set the trigger level with the pop-up numeric keypad. For details, refer to descriptions in [Trigger Level](#). The current trigger level is displayed in the trigger information label at the top of the screen.

- **Level C**

Sets the trigger level of SDA. Tap the "Trigger" icon on the small screen, then rotate the knob  at the upper-right part of the small screen to adjust the trigger level. You can also set the trigger level with the pop-up numeric keypad. For details, refer to descriptions in [Trigger Level](#). The current trigger level is displayed in the trigger information label at the top of the screen.

8.7.20 MIL-STD-1553 Trigger (Option)

1553B is the abbreviation for the MIL-STD-1553 bus. DS70000 can trigger on the sync field of 1553B bus, and can also trigger on the specified data word, command word, status word, or error type.

The command word, data word, and status word format of the 1553B bus is as shown in the figure below.

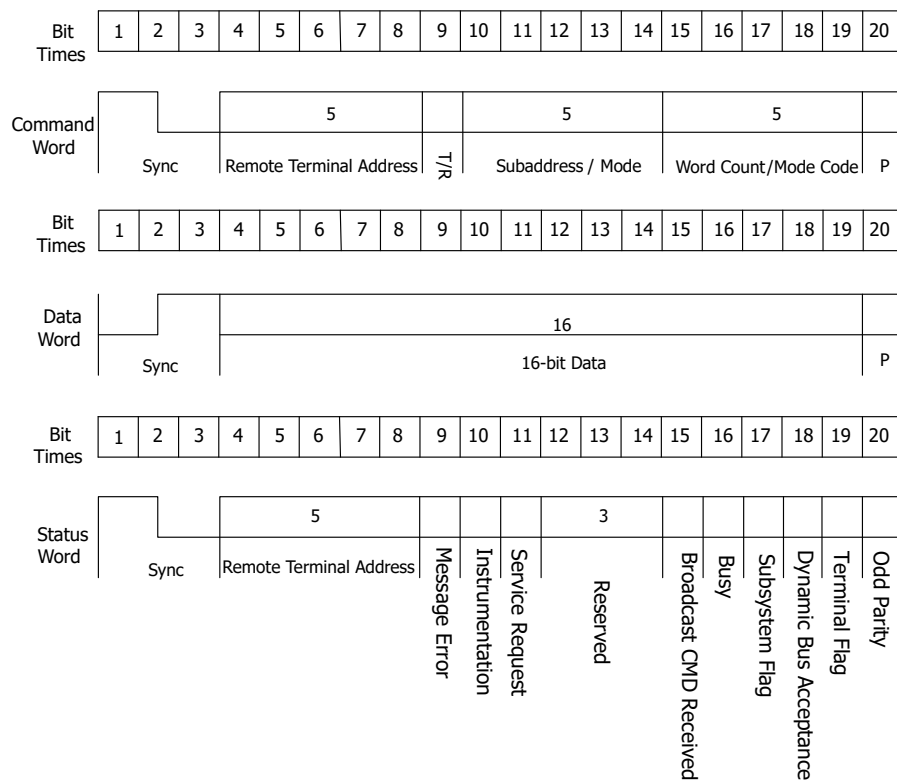

Figure 8.42 Formats of the Command Word, Data Word, and Status Word of the 1553B Bus

Trigger Type

Click or tap the drop-down button of **Type** to select "MIL-STD-1553" from the drop-down list. Then set the parameters for MIL-STD-1553 trigger.

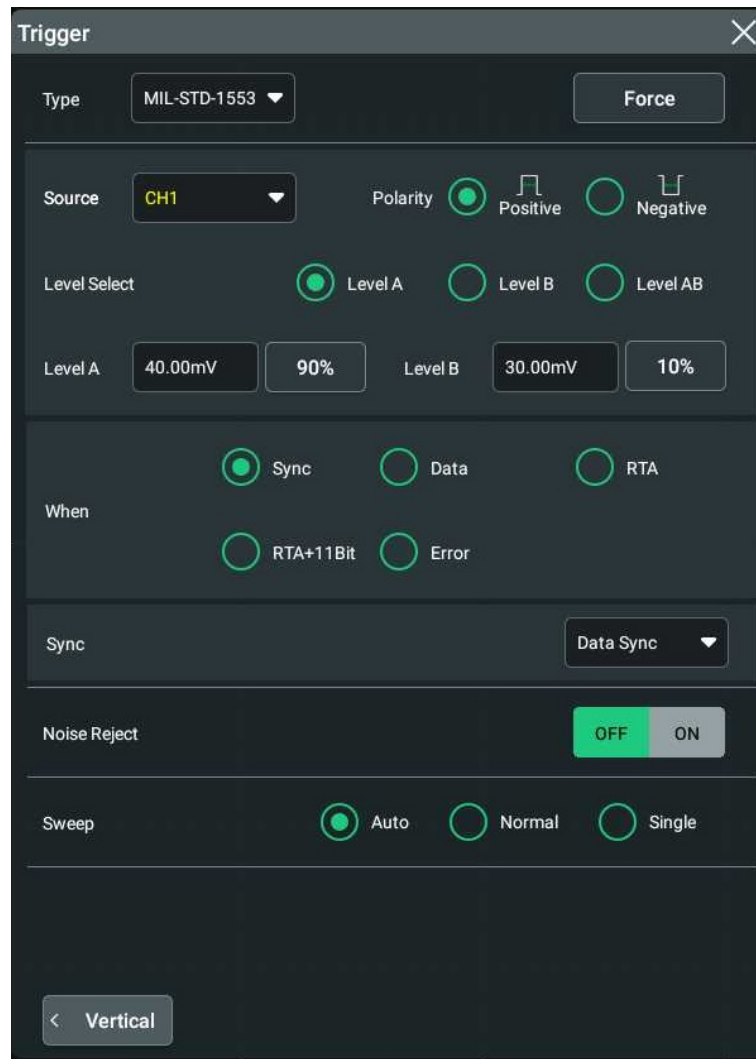
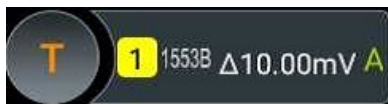

Figure 8.43 MIL-STD-1553 Trigger Setting Menu

After selecting the trigger type, and then the current trigger setting information (including trigger type, trigger source, and trigger level) is displayed in the trigger information label at the top of the screen, as shown in the figure below. The information will change based on the trigger settings.





Source Selection

Click or tap the drop-down button of **Source** to select CH1-CH4. For details, refer to descriptions in *Trigger Source*. The current trigger source is displayed in the trigger information label at the top of the screen.

Only when we select the channel (that has been input with signals) as the trigger source, can we obtain a stable trigger.

Polarity

Selects the desired polarity under the **Polarity** menu. The polarities available are positive polarity () and negative polarity (.

Level Selection and Setting

After the trigger condition setting is completed, you need to adjust the trigger level to correctly trigger the signal and obtain a stable waveform.

Select the level adjustment type under the **Level Select** menu.

- **Level A:** only adjusts the upper limit of the trigger level, and the lower limit of the trigger level remains unchanged.
- **Level B:** only adjusts the lower limit of the trigger level, and the upper limit of the trigger level remains unchanged.
- **Level AB:** adjusts the upper and lower limits of the trigger level at the same time, and the trigger level deviation (the difference between the upper limit and lower limit of the trigger level) remains unchanged.

In MIL-STD-1553 trigger, pressing down the trigger level knob at the upper-right part of the small screen can quickly switch the current level adjustment type.

When setting the trigger level, first select a level type and then tap the "Trigger" icon

on the small screen, rotate the knob  at the upper-right part of the small screen or drag the adjustment icon under the **Level A** and **Level B** menu item to adjust the level of Source A and Source B. For details, refer to descriptions in *Trigger Level*. The current trigger level is displayed in the trigger information label at the top of the screen.

Trigger Condition

Click or tap the drop-down button of **When** to select the desired trigger condition.

- **Sync:** triggers on the specified sync type. After this trigger condition is selected, click or tap the drop-down button of **Sync** to select the desired sync type: Data Sync, Cmd/Status Sync, or All Sync.
- **Data:** triggers on the specified data word. After this trigger condition is selected, click or tap the comparison conditions from the **Comp** menu. The available choices include =, ≠, >, <, ><, and <>.
 - **=:** triggers when the channel's data word equals the set data word. Click or tap the input field of **Min**, and then the "Format" interface is displayed. You can set the lower limit of the data word. For details, refer to descriptions in *I2C Trigger (Option)*.
 - **≠:** triggers when the channel's data word does not equal the set data word. Click or tap the input field of **Min**, and then the "Format" interface is

displayed. You can set the lower limit of the data word. For details, refer to descriptions in *I2C Trigger (Option)*.

- >: triggers when the channel's data word is greater than the set data word. Click or tap the input field of **Min**, and then the "Format" interface is displayed. You can set the lower limit of the data word. For details, refer to descriptions in *I2C Trigger (Option)*.
- <: triggers when the channel's data word is smaller than the set data word. Click or tap the input field of **Max**, and then the "Format" interface is displayed. You can set the upper limit of the data word. For details, refer to descriptions in *I2C Trigger (Option)*.
- < >: triggers when the channel's data word is smaller than the upper limit of the data word and greater than the lower limit of the data word. Click or tap the input field of **Max** and **Min**, and then the "Format" interface is displayed. You can set the upper limit and lower limit of the data word. For details, refer to descriptions in *I2C Trigger (Option)*.
- > <: triggers when the channel's data word is greater than the upper limit of the data word and smaller than the lower limit of the data word. Click or tap the input field of **Max** and **Min**, and then the "Format" interface is displayed. You can set the upper limit and lower limit of the data word. For details, refer to descriptions in *I2C Trigger (Option)*.
- **RTA**: triggers on the specified remote terminal address. After this trigger condition is selected, click or tap the input field of **RTA**, and then the "Format" interface is displayed. You can set the remote terminal address. For details, refer to descriptions in *I2C Trigger (Option)*.
- **RTA+11Bit**: triggers on the RTA and the remaining 11 bits.

After this trigger condition is selected:

- Click or tap the input field of **RTA**, and then the "Format" interface is displayed. You can set the remote terminal address. For details, refer to descriptions in *I2C Trigger (Option)*.
- Click or tap the input field of **Bit time**, and then the "Format" interface is displayed. You can set the bit time position value to 0 (low), 1 (high), or X (don't care). For details, refer to descriptions in *I2C Trigger (Option)*.
- **Error**: triggers on the specified error type. After this trigger condition is selected, click or tap the drop-down button of **Err Type** to select the error type.
 - **Sync Error**: triggers when an invalid sync pulse is found.
 - **Check Error**: triggers when the parity bit is incorrect for the data in the word.

Trigger Mode

In **Sweep** menu, select Auto, Normal, or Single as the trigger mode. For details, refer to descriptions in *Trigger Mode*.

Trigger Parameter Setting

Sets the trigger parameter (noise rejection) under this trigger type. For details, refer to descriptions in *Noise Reject*.

8.8 Trigger Output Connector



The trigger output connector (**[AUX OUT]**) on the rear panel of DS70000 series can output trigger signals (trigger hardware) determined by the current setting.

Click or tap the function navigation icon  at the lower-left corner of the screen, and then select "Utility" to enter the utility function menu. Click or tap **Setup**, and then in the **Aux Out** menu, select "TrigOut". You can also tap the **Utility** icon on the small screen to enter the utility function menu. A signal which reflects the current oscilloscope capture rate can be output from **[AUX OUT]** connector each time a trigger is generated by the oscilloscope. If this signal is connected to a waveform display device to measure the frequency, the measurement result is the same as the current capture rate.

If "PassFail" is selected for the **Aux Out** menu, the instrument can output a pulse from the **[AUX OUT]** connector when a pass/failed event is detected during the pass/fail test.

9 Math Operation

This series of oscilloscopes can realize multiple math operations between waveforms of different channels, including arithmetic operation, spectrum operation, logic operation, function operation, and digital filter. To enter the **Math** menu, perform any of the following operations:

- Click or tap the function navigation icon  at the lower-left corner of the screen, and then select **Math** to enter the “Math” menu.
- Click or tap the Math1 ~ Math4 label at the bottom of the screen, and the corresponding interface appears on the screen, as shown in *Figure 9.2*. Click or tap the label again, or the icon  at the upper-right corner of the window to enter the math operation menu.

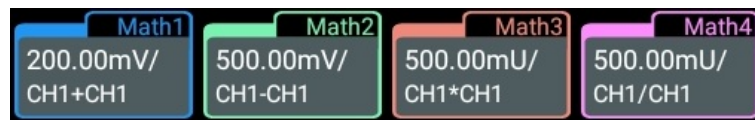

- Tap the **Math** icon on the small screen at the right side of the device to enter the math operation menu.

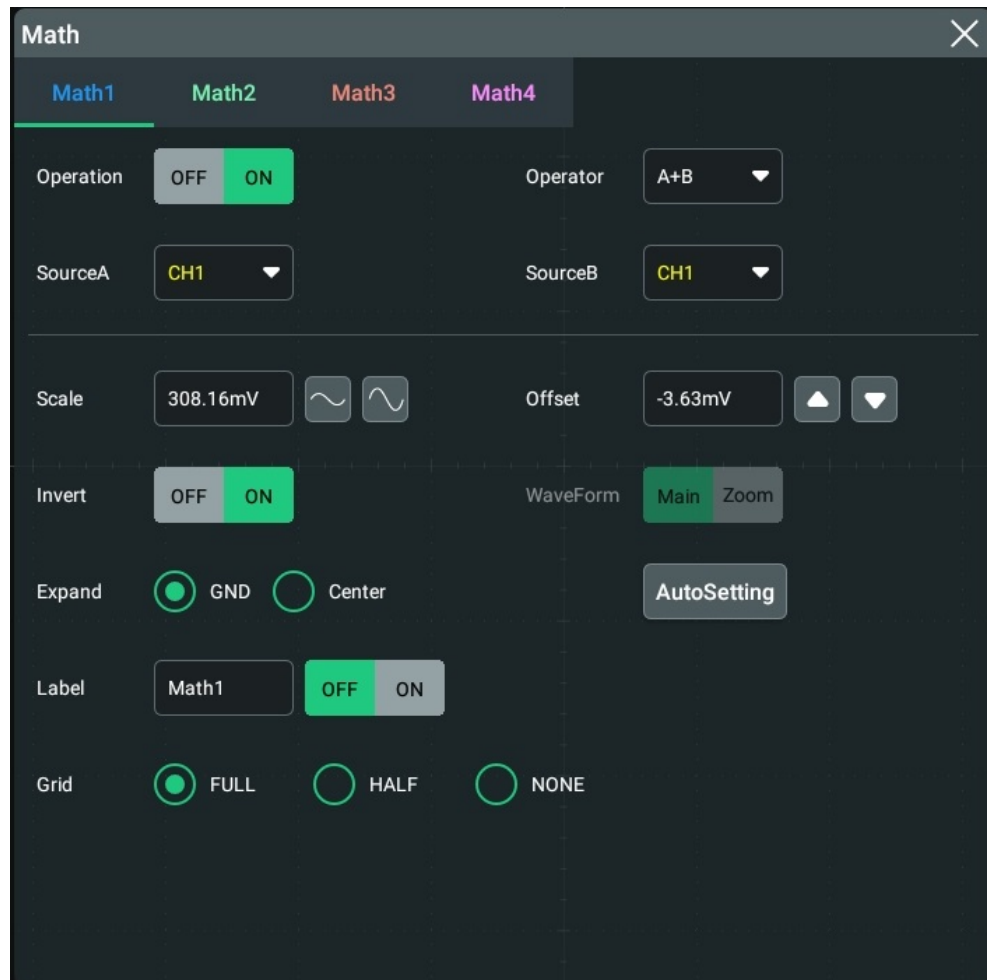

Figure 9.1 Math Operation Menu

This oscilloscope provides four math operations: Math1, Math2, Math3, and Math4. Users can select the math operation type by clicking or tapping the **Math1 ~ Math4** label or by sliding the menu left and right to select the desired **Math** menu item. This manual section takes Math1 as an example to introduce math operation.

In the **Math** menu, click or tap the ON/OFF tab for the **Operation** menu to show or hide the waveform display window of the operation results. By default, it is OFF. When set to ON, the figure as shown in *Figure 9.2* is displayed on the screen.

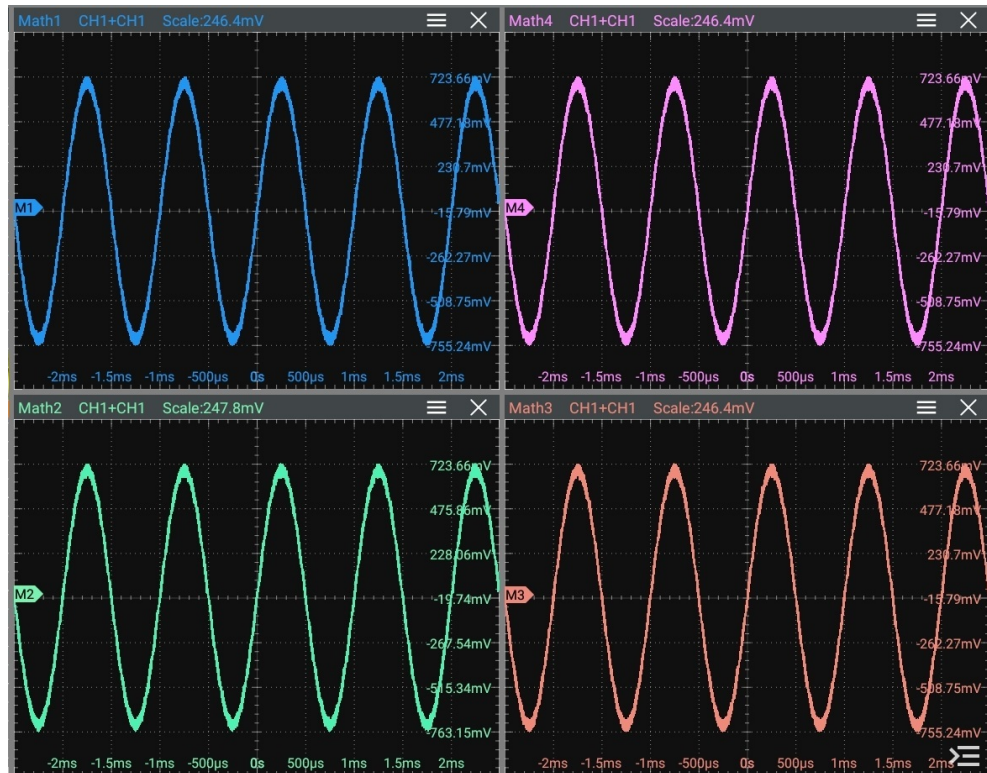



Figure 9.2 Waveform Display Window of the Operation Results

Users can drag the title bar of the display window to change the position of the window. You can also click/tap the close button  at the upper-right corner of the window to close it.

9.1 Arithmetic Operation

In the **Math** menu, click or tap **Operator** to select the desired math operation. The arithmetic operations supported by this oscilloscope include $A+B$, $A-B$, $A \times B$, and $A \div B$.

- **$A+B$** : adds the waveform voltage values of signal source A and B point by point and displays the results.
- **$A-B$** : subtracts the waveform voltage values of signal source B from that of source A point by point and displays the results.
- **$A \times B$** : multiplies the waveform voltage values of signal source A and B point by point and displays the results.
- **$A \div B$** : divides the waveform voltage values of signal source A by that of source B point by point and displays the results. It can be used to analyze the Multiple relation of the two channels waveforms.

**TIP**

When the voltage of signal source B is 0 V, the division result is treated as 0.

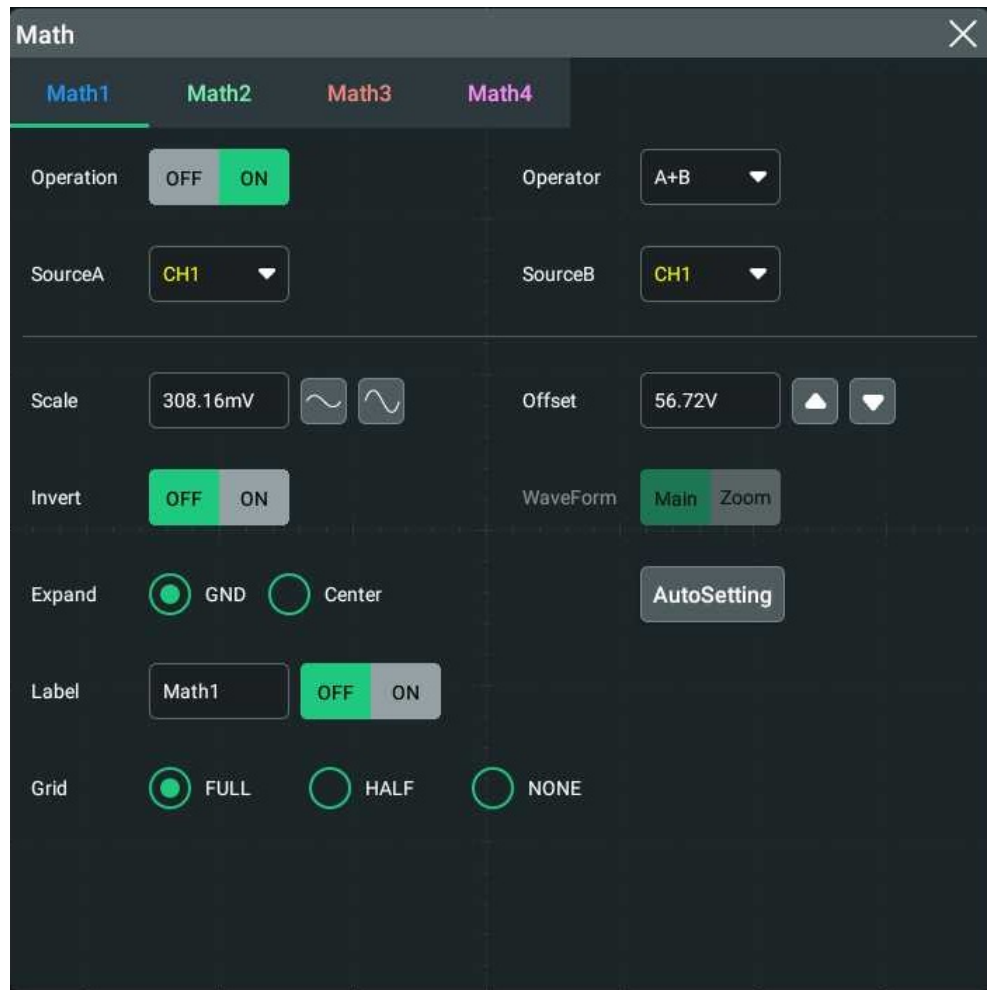

Figure 9.3 Arithmetic Operation Menu

Operation Result Display Window

Click or tap the ON/OFF tab for the **Operation** menu to enable or disable the display of the arithmetic operation result window. The source and the vertical scale parameters are displayed at the top of the window, as shown in the figure below.

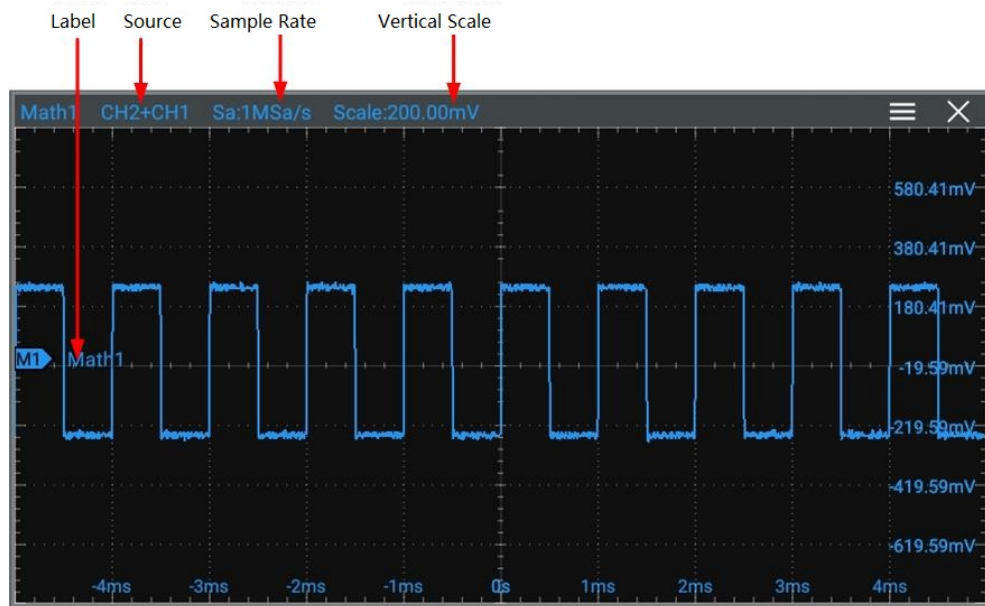

Figure 9.4 Operation Result Display Window

Source

Click or tap the drop-down button of **SourceA** or **SourceB** to select CH1, CH2, CH3, or CH4. When a source channel is selected, the selected channel automatically switches to the ON state.

Scale

Scale is used to set the vertical scale of the operation result. For setting methods, refer to descriptions in *To Adjust the Vertical Scale*.

Offset

Offset is used to set the vertical offset of the operation result. For setting methods, refer to descriptions in *To Adjust the Vertical Offset*.

Invert

Invert is used to enable or disable the inverted display function of the waveform. For setting methods, refer to descriptions in *Waveform Invert*.

Waveform

This oscilloscope supports Main and Zoom. By default, it is Main.

- **MAIN:** indicates that the measurement range is within the main time base region.
- **ZOOM:** indicates that the measurement range is within the zoomed time base region.

When you select "Zoom", you need to enable *Delayed Sweep* in *To Set the Horizontal System*.

Expand

The oscilloscope supports two vertical expansion modes: GND and Center. By default, it is "GND".

- **GND:** when the vertical scale is changed, the math operation waveform will be expanded or compressed around the signal ground level position.
- **Center:** when the vertical scale is changed, the math operation waveform will be expanded or compressed around the screen center.

Auto Set

Click or tap **AutoSetting** to adjust the vertical scale and the offset of the operation results to the optimal value according to the current configuration, so as to better to observe.

Label

Label is used to set the label for the math operation results. For setting methods, refer to descriptions in *Channel Label*.

Grid

For setting methods, refer to the descriptions in *To Set the Screen Grid*.

9.2 Function Operation

In the **Math** menu, click or tap the drop-down button of **Operator** to select the desired function operation. The available function operation types of this oscilloscope include Intg, Diff, Sqrt, Lg (Base 10 Exponential), Ln, Exp, Abs, and AX+B.

- **Intg:** calculates the integral of the selected source. For example, you can use integral to measure the area under a waveform or the pulse energy.
- **Diff:** calculates the discrete time derivative of the selected source. For example, you can use differentiate to measure the instantaneous slope of a waveform.
- **Sqrt:** calculates the square roots of the selected source point by point and displays the results.
- **Lg (Base 10 Exponential):** calculates the base 10 exponential of the selected source point by point and displays the results.
- **Ln:** calculates the natural logarithm (Ln) of the selected source point by point and displays the results.

- **Exp**: calculates the exponential of the selected source point by point and displays the results.
- **Abs**: calculates the absolute value of the selected source and displays the results.
- **AX+B**: applies a linear function to the selected source, and displays the results.

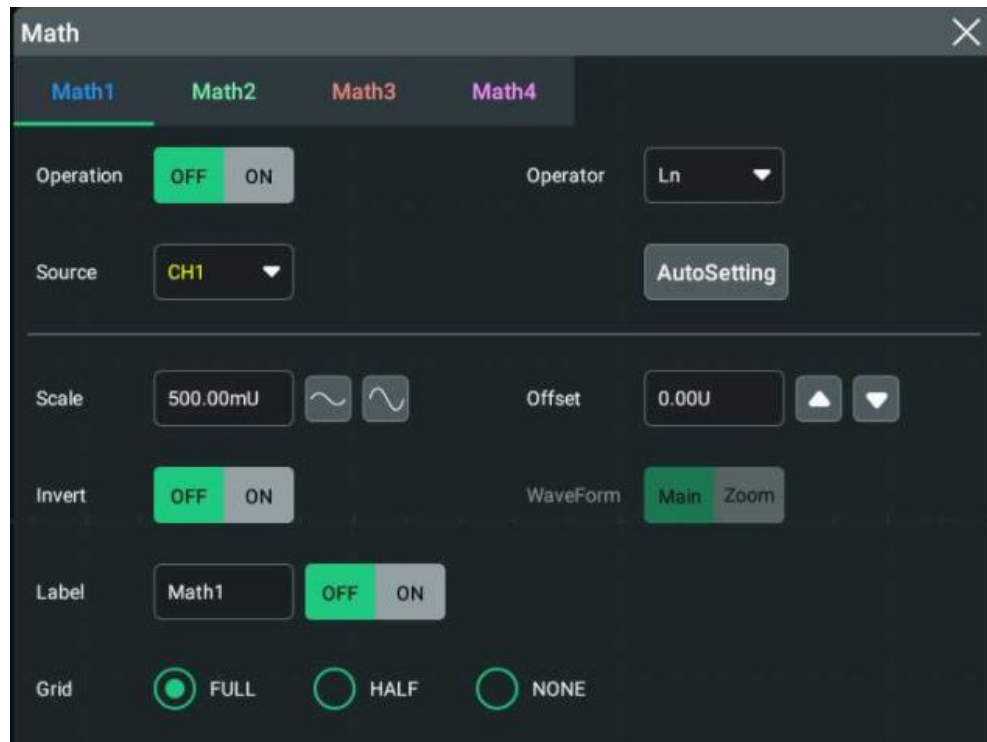

Figure 9.5 Function Operation Menu

Operation Result Display Window

Click or tap the ON/OFF tab for the **Operation** menu to enable or disable the display of the operation result window. The source and the vertical scale parameters are displayed at the top of the window, as shown in the figure below.

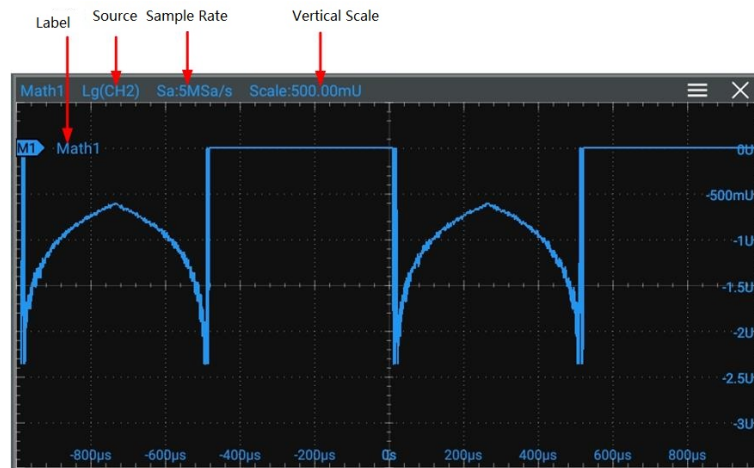

Figure 9.6 Operation Result Display Window

Source

Click the drop-down button for the **Source** menu to select the source as CH1, CH2, CH3, and CH4. When a source channel is selected, the selected channel automatically switches to the ON state.

Auto Set

Click or tap **AutoSetting** to adjust the vertical scale and the offset of the operation results to the optimal value according to the current configuration, so as to better to observe.

Scale

Scale is used to set the vertical scale of the operation result. For setting methods, refer to descriptions in *To Adjust the Vertical Scale*.

Offset

Offset is used to set the vertical offset of the operation result. For setting methods, refer to descriptions in *To Adjust the Vertical Offset*.

Invert

Invert is used to enable or disable the inverted display function of the waveform. For setting methods, refer to descriptions in *Waveform Invert*.

Waveform

This oscilloscope supports Main and Zoom. By default, it is Main.

- **MAIN:** indicates that the measurement range is within the main time base region.

- **ZOOM:** indicates that the measurement range is within the zoomed time base region.

When you select "Zoom", you need to enable *Delayed Sweep* in *To Set the Horizontal System*.

Label

Label is used to set the label for the math operation results. For setting methods, refer to descriptions in *Channel Label*.

Grid

For setting methods, refer to the descriptions in *To Set the Screen Grid*.

Parameter Setting

- When the operator is "Intg", click or tap the input field for the **Offset** menu item and use the pop-up numeric keypad to set the DC offset calibration factor of the input signal.
- When the operator is "Diff", click or tap the input field for the **Smooth** menu item and use the pop-up numeric keypad to set the number of smooth times for the differential operation.

9.3 FFT Operation

FFT (Fast Fourier Transform) is used to transform time-domain signals to frequency-domain components (frequency spectrum). This oscilloscope provides FFT operation function which enables you to observe the time-domain waveform and spectrum of the signal at the same time. FFT operation can facilitate the following works:

- Measure harmonic components and distortion in the system;
- Display the characteristics of the noise in DC power;
- Analyze vibration.

In the **Math** menu, click or tap the drop-down button of **Operator** to select **FFT** to go to the menu shown in *Figure 9.7*. Then configure the parameters of FFT.

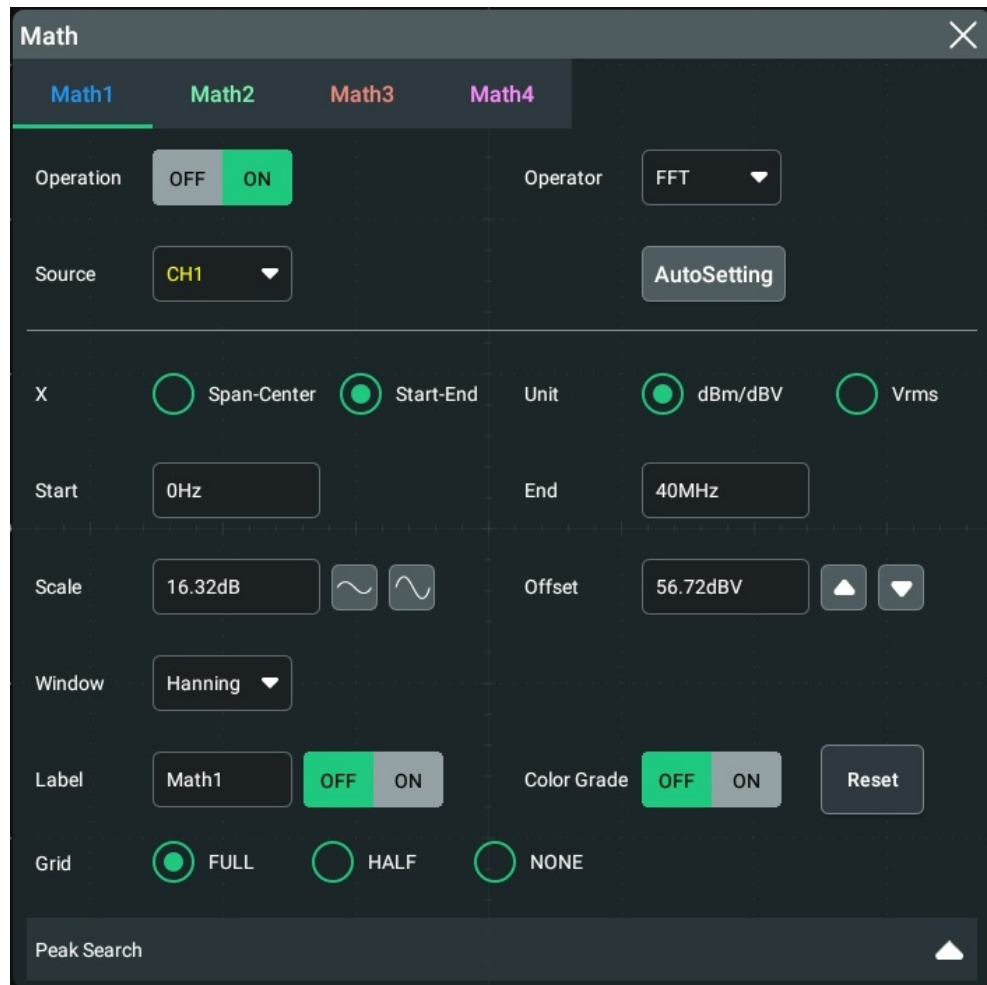

Figure 9.7 FFT Operation Menu

Operation

Click or tap the on/off tab for the **Operation** menu to enable or disable the FFT operation result window. The parameters such as center frequency, frequency range, and resolution are displayed at the top of the window, as shown in the figure below. Of which, FFT resolution is the quotient of the sample rate and the number of FFT points. If the number of FFT points is a fixed value (65535 at most), then the lower the sample rate, the higher the resolution.

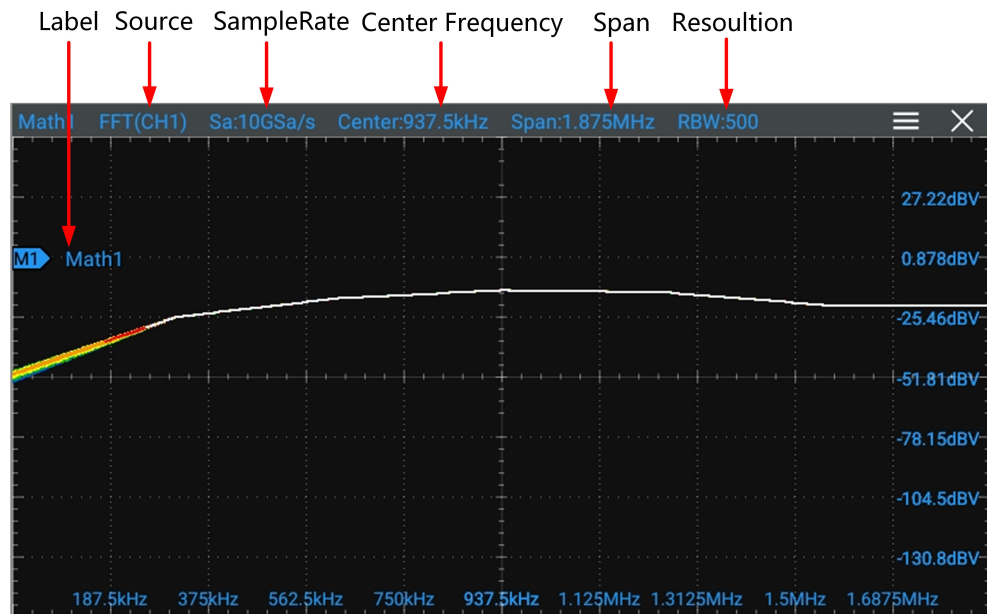

Figure 9.8 FFT Operation Window

Source

Click or tap the drop-down button for the **Source** to select CH1, CH2, CH3, or CH4 as the source. When a source channel is selected, the selected channel automatically switches to the ON state.

Auto Set

Click or tap **AutoSetting** to adjust the vertical scale and the offset of the operation results to the optimal value according to the current configuration, so as to better to observe.

Frequency Range

In the **X** menu, select "Span-Center" (frequency span to center frequency) or "Start-End" (start frequency to stop frequency) as a frequency range mode.

- **Span-Center (frequency span to center frequency):** the frequency span refers to the screen width, and you can divide the frequency range by 10 to obtain the frequency per division.

Click or tap the input field of **Center** to set the frequency of the frequency-domain waveform relative to the horizontal center of the screen. Its range is from 5 Hz to 5 GHz. By default, it is 5 MHz. Click or tap the input field of **Span** to set the frequency range of the frequency-domain waveform. Its range is from 10 Hz to 5 GHz. By default, it is 10 MHz.

- **Start-End (start frequency to stop frequency):** Start frequency refers to the frequency shown at the left side of the screen. Click or tap the input field of **Start** to set the start frequency of the frequency-domain waveform. Its range is from 0 Hz to (stop frequency - 10 Hz). By default it is 0 Hz. Stop frequency refers

to the frequency shown at the right side of the screen. Click or tap the input field of **End** to set the stop frequency of the frequency-domain waveform. Its range is from (start frequency + 10 Hz) to 5 GHz. By default, it is 10 MHz.

Vertical Scale/Offset

Selects **dBm/dBV** or **Vrms** as the unit for **Scale** and **Offset**.

For setting methods of **Scale**, refer to the descriptions in *To Adjust the Vertical Scale*.

For setting methods of **Offset**, refer to the descriptions in *To Adjust the Vertical Offset*.

Window Function

Spectral leakage can be considerably decreased when a window function is used. The oscilloscope provides 6 FFT window functions which have different characteristics and are applicable to measure different waveforms. You need to select the window function according to the characteristics of the waveform to be measured. Click or tap the drop-down button of **Window** to select the desired window function.

Table 9.1 Window Function

Window Function	Characteristics	Waveforms Applicable to the Window Function
Rectangular	Best frequency resolution Poorest amplitude resolution Similar to the situation when no window is applied.	Transient or short pulse, the signal levels before and after the multiplication are basically the same Sine waveforms with the same amplitudes and rather similar frequencies Wide band random noise with relatively slow change of waveform spectrum
Blackman-Harris	Best amplitude resolution Poorest frequency resolution	Single frequency signal, searching for higher order harmonics
Hanning	Better frequency resolution and poorer amplitude resolution compared with Rectangular	Sine, periodic, and narrow band random noise
Hamming	A little bit better frequency resolution than Hanning	Transient or short pulse, the signal levels before and after the multiplication are rather different

Window Function	Characteristics	Waveforms Applicable to the Window Function
Flattop	Measure the signals accurately	Measure the signal that has no accurate reference and requires an accurate measurement
Triangle	Better frequency resolution	Measure the narrow band signal and that has strong noise interference

Color Grade

Click or tap the ON/OFF button for the **Color Grade** item to enable/disable the color grade display of FFT operation results. When enabled, different colors are displayed on the screen to indicate the times of data acquisition or acquisition probability. Click or tap the **Reset** button for the Color Grade menu to clear the color grade display and display the color grade again.

Peak Search

Click or tap the icon  at the right side of **Peak Search** to enter the peak search menu, as shown in the figure below.

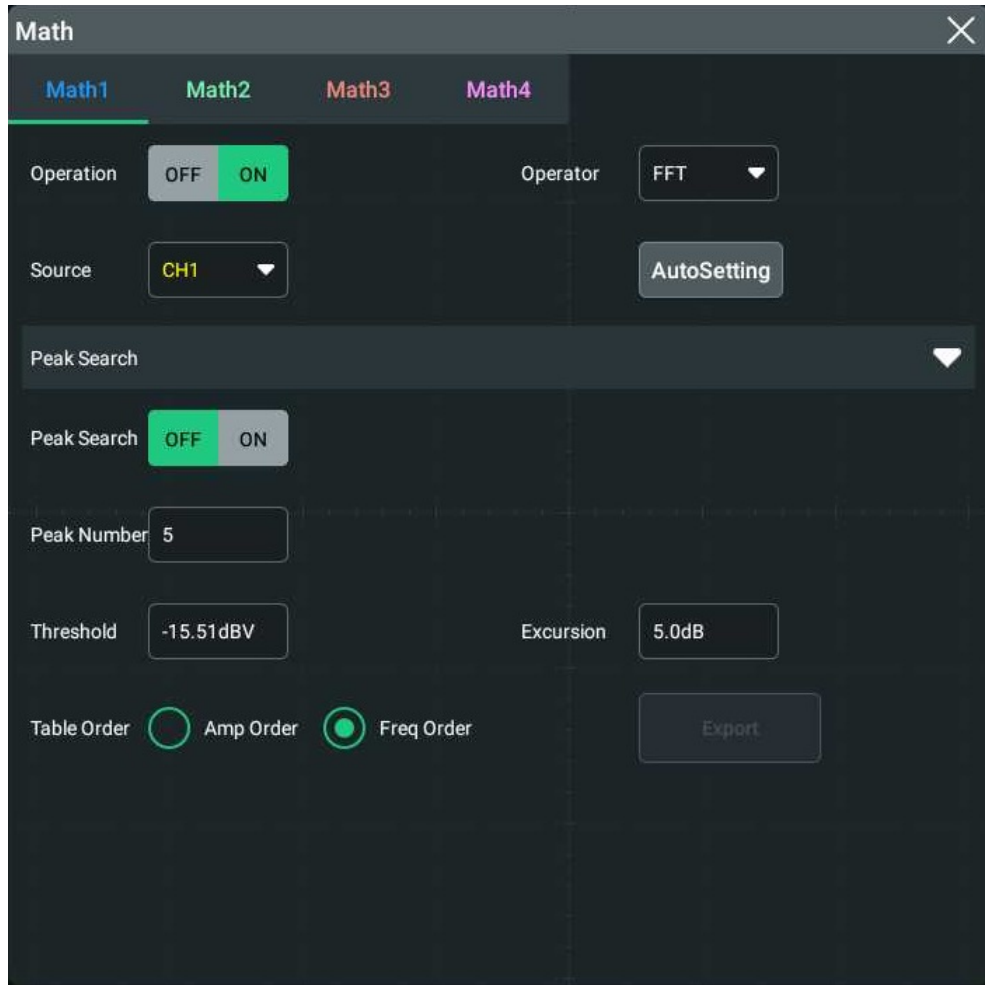



Figure 9.9 Peak Search

- **Peak Search ON/OFF:** click or tap the ON/OFF button for the **Peak Search** menu to enable or disable the display of the peak search window. By default, it is OFF.
- **Peak Number:** click or tap the input field for the **Peak Number** menu item and use the pop-up numeric keypad to set the number of peaks. Its range is from 1 to 15. Its default value is 5.
- **Threshold:** click or tap the input field for the **Threshold** menu item to set the threshold of the peak with the pop-up numeric keypad. The range of the threshold is related to the current FFT scale and offset.
- **Excursion:** click or tap the input field for the **Excursion** menu item to set the excursion of the peak. The min. value of Excursion is 0 and its unit is dB.
- **Table Order:** click or tap to select **Amp Order** or **Freq Order** as the sorting mode under the **Table Order** menu. By default, it is "Amp Order".

Click or tap **Export**, then the save setting interface is displayed. You can export the peak search results to the internal memory or the external USB storage device in CSV format. For detailed saving operation, refer to *To Save a File* and *Disk Management*.

Clicking or tapping the icon  at the right side of **Peak Search** can close the peak search menu.

9.4 Logic Operation

In the **Math** menu, click or tap **Operator** to select the desired math operation. The logic operations supported by this oscilloscope include $A \& B$, $A || B$, $A \wedge B$, and $\neg A$. After selecting the desired logic operation from the drop-down list of **Operator**, you can configure its settings for the selected logic operation type.

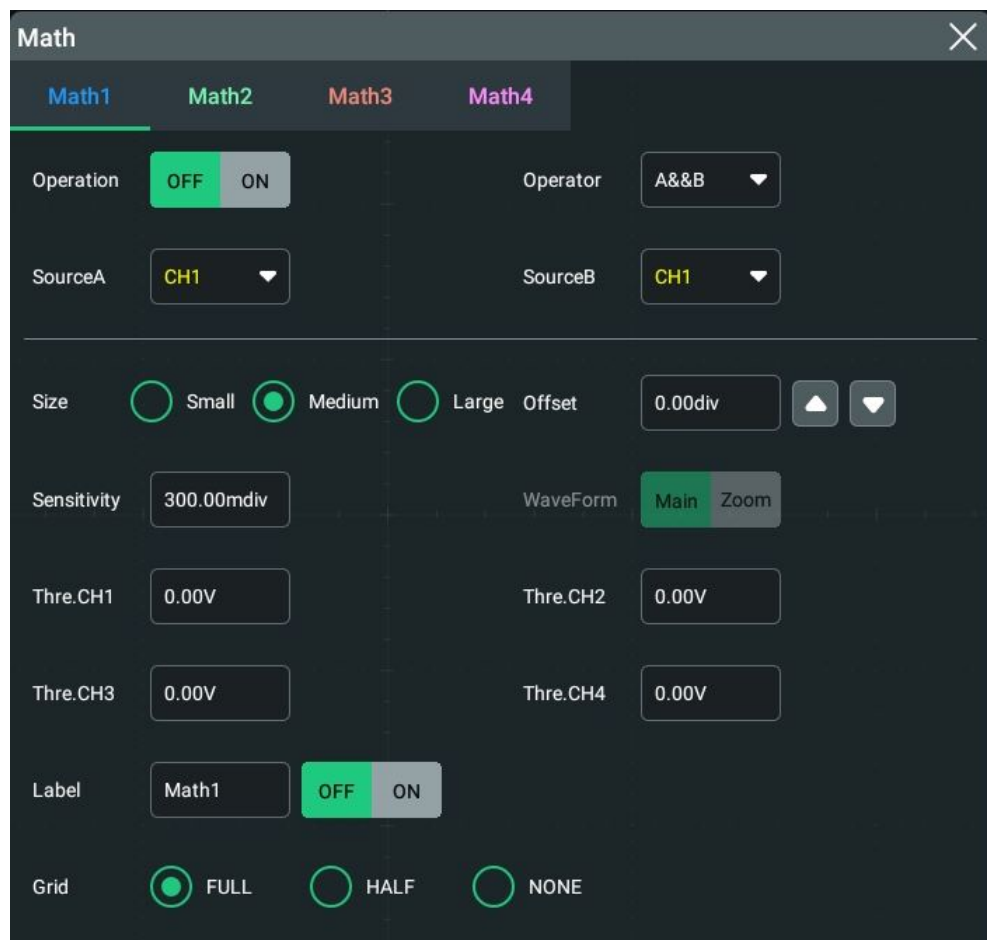

Figure 9.10 Logic Operation Menu

- **A&&B:** Performs logic "AND" operation on the waveform voltage values of the specified sources point by point and displays the results. In operation, when the voltage value of the source channel is greater than the threshold of the corresponding channel, it is regarded as logic "1"; otherwise it is logic "0". The results of logic AND operation of two binary bits are shown in [Table 9.2 Logic Operation](#).
- **A||B:** Performs logic "OR" operation on the waveform voltage values of the specified sources point by point and displays the results. In operation, when the

voltage value of the source channel is greater than the threshold of the corresponding channel, it is regarded as logic "1"; otherwise it is logic "0". The results of logic OR operation of two binary bits are shown in *Table 9.2 Logic Operation*.

- **A^B:** Performs logic "XOR" operation on the waveform voltage values of the specified sources point by point and displays the results. In operation, when the voltage value of the source channel is greater than the threshold of the corresponding channel, it is regarded as logic "1"; otherwise it is logic "0". The results of logic XOR operation of two binary bits are shown in *Table 9.2 Logic Operation*.
- **!A:** Performs logic "NOT" operation on the waveform voltage values of the specified sources point by point and displays the results. In operation, when the voltage value of the source channel is greater than the threshold of the corresponding channel, it is regarded as logic "1"; otherwise it is logic "0". The results of logic "NOT" operation of one binary bit are shown in *Table 9.2 Logic Operation*.

Table 9.2 Logic Operation

A	B	A&&B	A B	A^B	!A
0	0	0	0	0	1
0	1	0	1	1	1
1	0	0	1	1	0
1	1	1	1	0	0

Operation Result Display Window

Click or tap the ON/OFF tab for the **Operation** menu to enable or disable the display of the operation result window. The source and the waveform sizes parameters are displayed at the top of the window, as shown in the figure below.

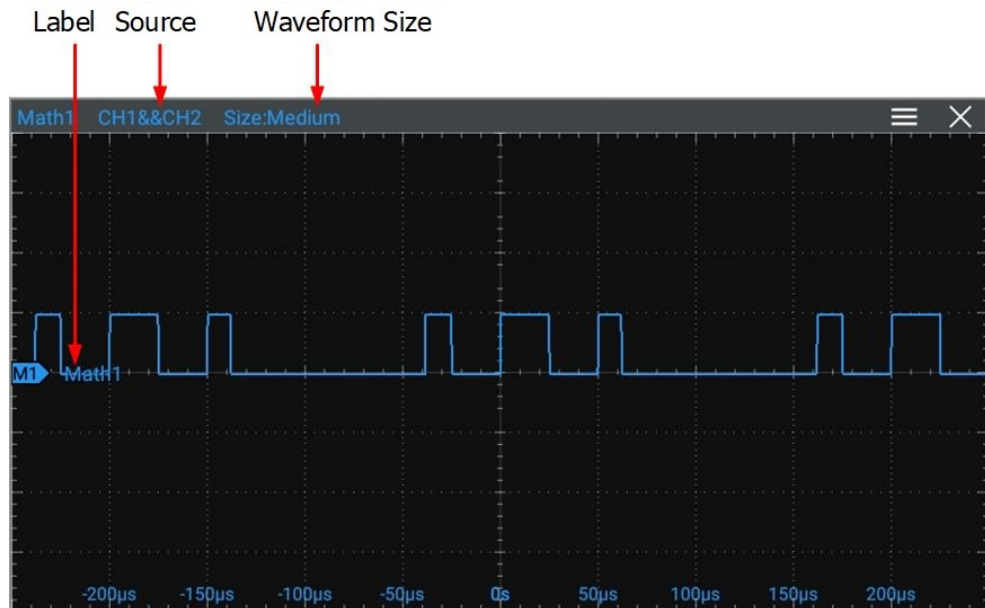

Figure 9.11 Operation Result Display Window

Source

Click or tap the drop-down button of **SourceA** or **SourceB** to select CH1, CH2, CH3, or CH4. When a source channel is selected, the selected channel automatically switches to the ON state.

Wave Size

Click or tap to select "Small", "Medium", or "Large" as the the waveform display mode.



Offset

Offset is used to set the vertical offset of the operation result. For setting methods, refer to descriptions in *To Adjust the Vertical Offset*.

Sensitivity

Sets the sensitivity of the digital signal converted from the analog signal on the source. Click or tap the input field of this menu to set the sensitivity with the pop-up numeric keypad. For detailed operations, refer to the descriptions in *Parameter Setting Method*.

Waveform

This oscilloscope supports Main and Zoom. By default, it is Main.

- **MAIN:** indicates that the measurement range is within the main time base region.
- **ZOOM:** indicates that the measurement range is within the zoomed time base region.

When you select "Zoom", you need to enable *Delayed Sweep* in *To Set the Horizontal System*.

Threshold

Click or tap the input field for the threshold menu of the specified channel and use the pop-up numeric keypad to set the threshold. For detailed operations, refer to the descriptions in *Parameter Setting Method*.



Label

Label is used to set the label for the math operation results. For setting methods, refer to descriptions in *Channel Label*.

Grid

For setting methods, refer to the descriptions in *To Set the Screen Grid*.

9.5 Digital Filter

In the **Math** menu, click or tap **Operator** to select the desired math operation. The digital filter supported by this oscilloscope includes: low-pass filter, high-pass filter, band-pass filter, and band-stop filter.

- **LowPass:** only allows the signals whose frequencies are lower than the current upper limit frequency to pass.
- **HighPass:** only allows the signals whose frequencies are higher than the current lower limit frequency to pass.
- **BandPass:** only allows the signals whose frequencies are higher than the current lower limit frequency and lower than the current upper limit frequency to pass.
- **BandStop:** only allows the signals whose frequencies are lower than the current lower limit frequency or higher than the current upper limit frequency to pass.

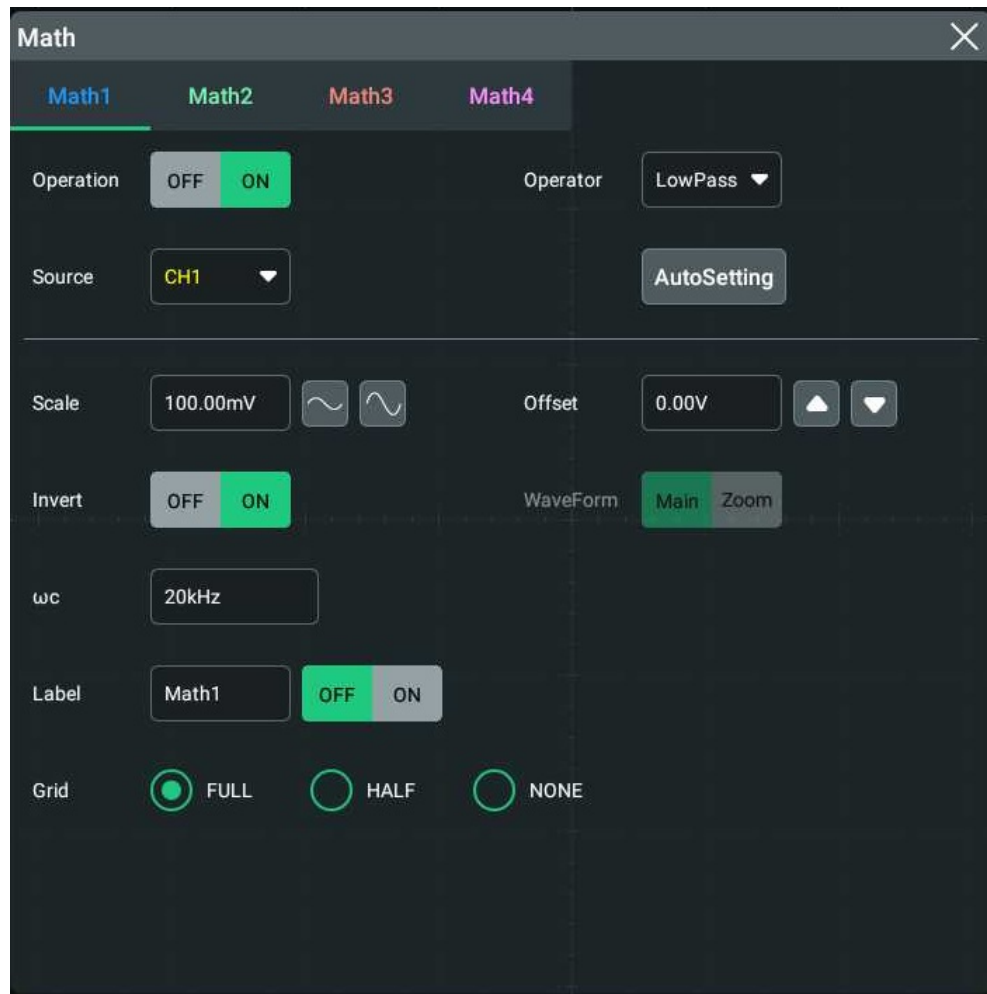

Figure 9.12 Digital Filter Menu

Operation Result Display Window

Click or tap the on/off tab for the **Operation** menu to enable or disable the display of the operation result window. The source and the vertical scale parameters are displayed at the top of the window, as shown in the figure below.

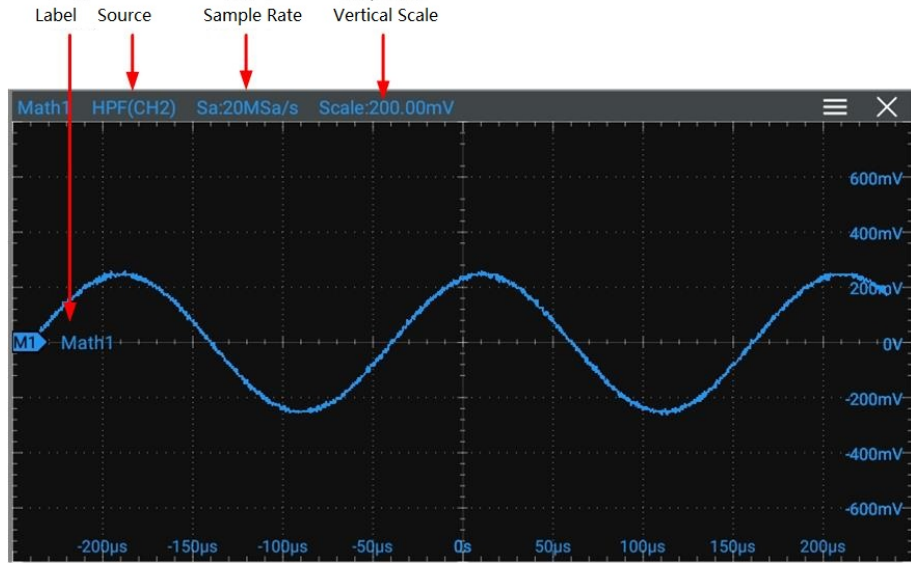

Figure 9.13 Operation Result Display Window

Source

Click or tap the drop-down button for the **Source** to select CH1, CH2, CH3, or CH4 as the source. When a source channel is selected, the selected channel automatically switches to the ON state.

Auto Set

Click or tap **AutoSetting** to adjust the vertical scale and the offset of the operation results to the optimal value according to the current configuration, so as to better to observe.

Scale

Scale is used to set the vertical scale of the operation result. For setting methods, refer to descriptions in *To Adjust the Vertical Scale*.

Offset

Offset is used to set the vertical offset of the operation result. For setting methods, refer to descriptions in *To Adjust the Vertical Offset*.

Invert

Invert is used to enable or disable the inverted display function of the waveform. For setting methods, refer to descriptions in *Waveform Invert*.

Waveform

This oscilloscope supports Main and Zoom. By default, it is Main.

- **MAIN:** indicates that the measurement range is within the main time base region.
- **ZOOM:** indicates that the measurement range is within the zoomed time base region.

When you select "Zoom", you need to enable *Delayed Sweep* in *To Set the Horizontal System*.

Frequency Limit

- **LowPass:** click or tap the input field for the **wc** menu item and use the pop-up numeric keypad to set the upper limit frequency.
- **HighPass:** click or tap the input field for the **wc** menu item and use the pop-up numeric keypad to set the lower limit frequency.
- **BandPass:** click or tap the input field for the **wc1** menu item and use the pop-up numeric keypad to set the lower limit frequency. Click or tap the input field for the **wc2** menu item and use the pop-up numeric keypad to set the upper limit frequency.
- **BandStop:** click or tap the input field for the **wc1** menu item and use the pop-up numeric keypad to set the lower limit frequency. Click or tap the input field for the **wc2** menu item and use the pop-up numeric keypad to set the upper limit frequency.

The settable ranges of the upper and lower limit frequencies are related to the Math sample rate (displayed at the bottom of the screen when the Math function is enabled). The sample rate of the analog channel or the changes of the memory depth can affect the Math sample rate.

Label

Label is used to set the label for the math operation results. For setting methods, refer to descriptions in *Channel Label*.

Grid

For setting methods, refer to the descriptions in *To Set the Screen Grid*.

10 Measure

To enter the **Measure** menu, perform any of the following operations:

- Click or tap the function navigation icon  at the lower-left corner of the screen, and then select **Measure** to enter the "Measure" menu.
- Tap the **Measure** icon on the small screen at the right side of the screen to enter the "Measure" menu.
- Click or tap the **Measure** icon at the upper right part of the screen enter the "Measure" menu.
- In *To Set the Vertical System* menu, click or tap the **Measure** button to enter the measurement setting menu.

10.1 Measurement Parameter

This oscilloscope allows you to set the measurement source, enable or disable the all measurement function, the statistical function, and etc. You can make quick measurements for many waveform parameters. The measurement results will be displayed at the right section of the screen under the **Result** list.



TIP

If there is no signal input for the current source or the measurement result is not within the valid range (too large or too small), then the measurement results are invalid, and "*****" is displayed on the screen. Please re-input the signal or set the signal.

10.1.1 Time Parameters

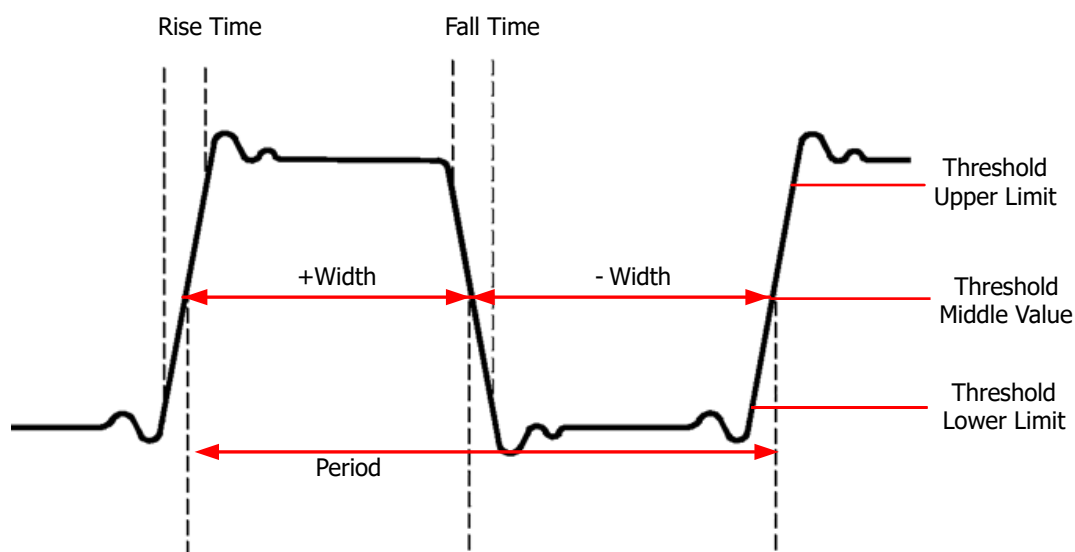

Figure 10.1 Time Parameters

- **Period:** defined as the time between the middle threshold points of two consecutive, like-polarity edges.
- **Frequency:** defined as the reciprocal of period.
- **Rise Time:** indicates the time for the signal amplitude to rise from the threshold lower limit to the threshold upper limit.
- **Fall Time:** indicates the time for the signal amplitude to rise from the threshold upper limit to the threshold lower limit.
- **+Width:** indicates the time between the threshold middle value of a rising edge to the threshold middle value of the next falling edge.
- **-Width:** indicates the time between the threshold middle value of a falling edge to the threshold middle value of the next rising edge.
- **+Duty:** indicates the ratio of the positive pulse width to the period.
- **-Duty:** indicates the ratio of the negative pulse width to the period.
- **T_{vmax}:** indicates the time that corresponds to the maximum value of the waveform (V_{max}).
- **T_{vmin}:** indicates the time that corresponds to the minimum value of the waveform (V_{min}).

The default values for threshold upper limit, threshold middle value, and threshold low limit are 90%, 50%, and 10%, respectively.

10.1.2 Count Values

The default values for threshold upper limit and threshold low limit are 90% and 10%, respectively.

Positive Pulse Count

The number of positive pulses that rise from under the threshold lower limit to above the threshold upper limit.

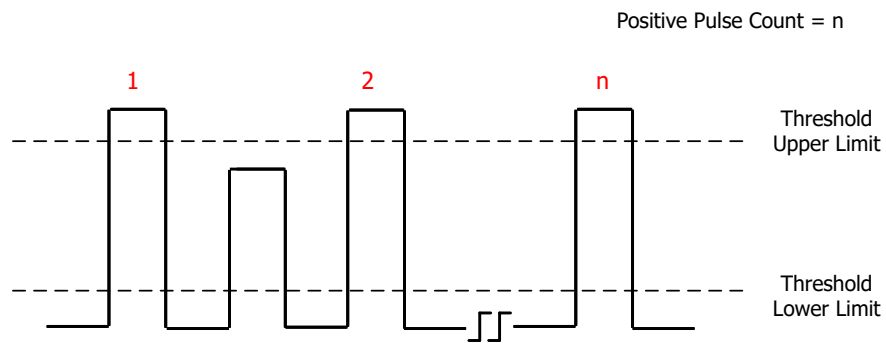

Negative Pulse Count

The number of negative pulses that fall from above the threshold upper limit to below the threshold lower limit.

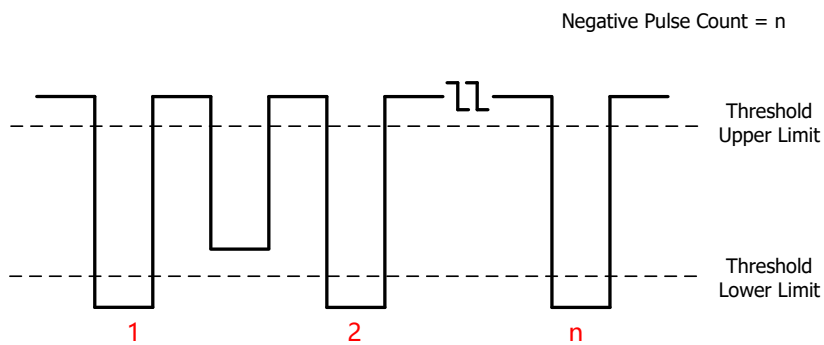

Rising Edge Count

The number of rising edges that rise from under the threshold lower limit to above the threshold upper limit.

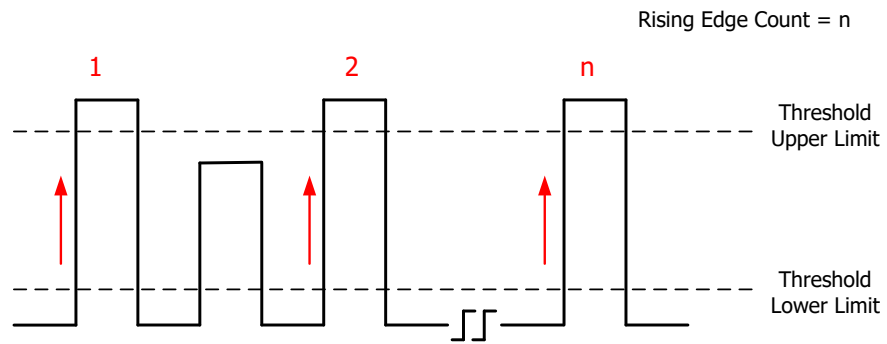

Falling Edge Count

The number of falling edges that fall from above the threshold upper limit to below the threshold lower limit.

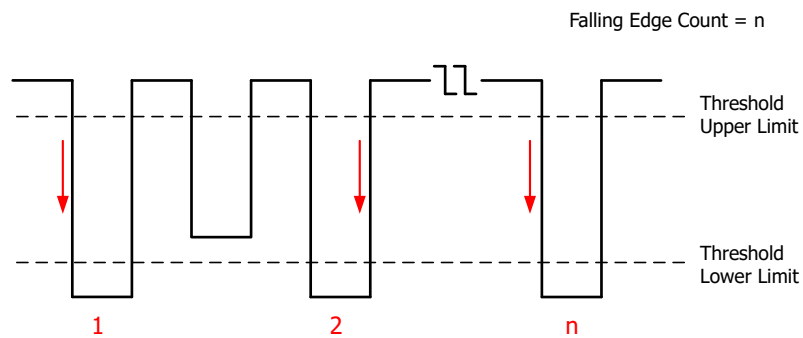

10.1.3 Delay and Phase Parameters

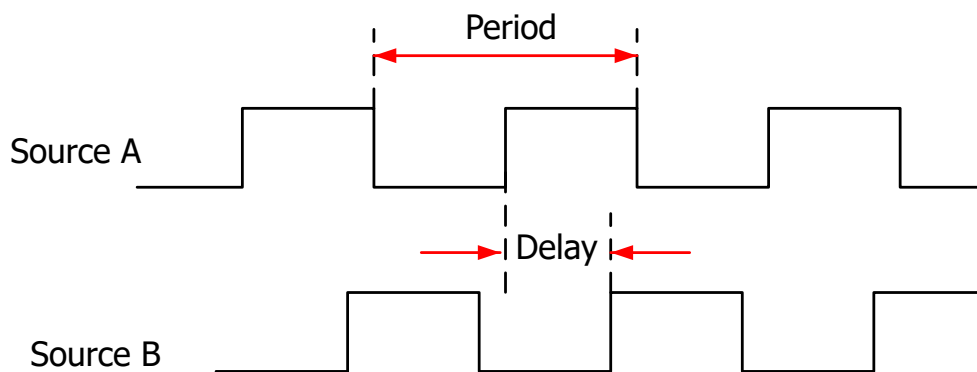

Figure 10.2 Delay and Phase Parameters

1. **Delay(r-r):** indicates the time difference between the threshold middle values of the rising edge of Source A and that of Source B. Negative delay indicates that the rising edge of Source A occurred after that of Source B.
2. **Delay(f-f):** indicates the time difference between the threshold middle values of the falling edge of Source A and that of Source B. Negative delay indicates that the falling edge of Source A occurred after that of Source B.
3. **Delay(r-f):** indicates the time difference between the threshold middle values of the rising edge of Source A and the falling edge of Source B. Negative delay indicates that the rising edge of Source A occurred after the falling edge of Source B.
4. **Delay(f-r):** indicates the time difference between the threshold middle values of the falling edge of Source A and the rising edge of Source B. Negative delay indicates that the falling edge of Source A occurred after the rising edge of Source B.
5. **Phase(r-r):** indicates the phase deviation between the threshold middle values of the rising edge of Source A and that of Source B. The phase formula is as follows:

$$PhaseA_{RB_R} = \frac{DelayA_{RB_R}}{Period_{sourceA}} \times 360^\circ$$

Wherein, $PhaseA_{RB_R}$ represents Phase(r-r), $DelayA_{RB_R}$ represents Delay(r-r), and $Period_{sourceA}$ represents period of Source A.

6. **Phase(f-f):** indicates the phase deviation between the threshold middle values of the falling edge of Source A and that of Source B. The phase formula is as follows:

$$PhaseA_{FB_F} = \frac{DelayA_{FB_F}}{Period_{sourceA}} \times 360^\circ$$

Wherein, $PhaseA_{RB_R}$ represents Phase(r-r), $DelayA_{RB_R}$ represents Delay(r-r), and $Period_{sourceA}$ represents period of Source A.

7. **Phase(r-f):** indicates the phase deviation between the threshold middle values of the rising edge of Source A and the falling edge of Source B. The phase formula is as follows:

$$PhaseA_{RB_F} = \frac{DelayA_{RB_F}}{Period_{sourceA}} \times 360^\circ$$

Wherein, $PhaseA_R B_R$ represents Phase(r-r), $DelayA_R B_R$ represents Delay(r-r), and $Period_{sourceA}$ represents period of Source A.

- 8. Phase(f-f):** indicates the phase deviation between the threshold middle values of the falling edge of Source A and the rising edge of Source B. The phase formula is as follows:

$$PhaseA_{F B_R} = \frac{DelayA_{F B_R}}{Period_{sourceA}} \times 360^\circ$$

Wherein, $PhaseA_R B_R$ represents Phase(r-r), $DelayA_R B_R$ represents Delay(r-r), and $Period_{sourceA}$ represents period of Source A.



TIP

- Source A and Source B can be any channel among CH1~ CH4 and Math1~ Math4.
- The default threshold middle value is 50%.

10.1.4 Voltage Parameters

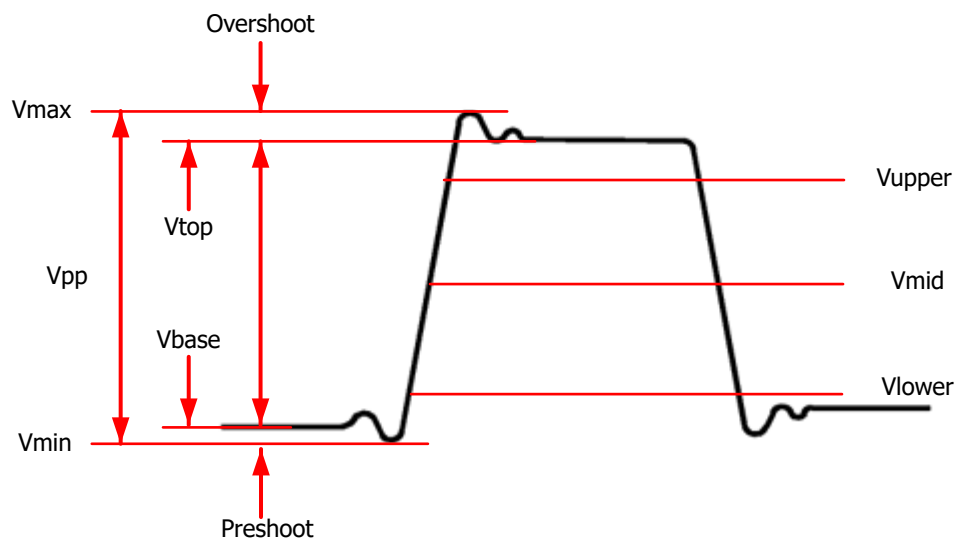

Figure 10.3 Voltage Parameters

- 1. Vmax:** indicates the voltage value from the highest point of the waveform to the GND.
- 2. Vmin:** indicates the voltage value from the lowest point of the waveform to the GND.
- 3. Vpp:** the voltage value from the highest point to the lowest point of the waveform.
- 4. Vtop:** indicates the voltage value from the flat top of the waveform to the GND.

- 5. Vbase:** indicates the voltage value from the flat base of the waveform to the GND.
- 6. Vamp:** indicates the voltage value from the top of the waveform to the base of the waveform.
- 7. Vupper:** indicates the actual voltage value that corresponds to the threshold maximum value.
- 8. Vmid:** indicates the actual voltage value that corresponds to the threshold middle value.
- 9. Vlower:** indicates the actual voltage value that corresponds to the threshold minimum value.
- 10. Vavg:** indicates the arithmetic average value on the whole waveform or in the gating area. The formula is shown as follows:

$$Average = \frac{\sum_{i=1}^n x_i}{n}$$

Wherein, x_i is the i th point, and n is the number of points being measured.

- 11. VRMS:** indicates the root mean square value on the whole waveform or in the gating area. The formula is as follows:

$$RMS = \sqrt{\frac{\sum_{i=1}^n x_i^2}{n}}$$

Wherein, x_i is the measurement result of the i th point, and n is the number of points being measured.

- 12. Per.VRMS:** indicates the root mean square value within a period. The formula is as shown above.
- 13. Overshoot:** indicates the ratio of the difference between the maximum value and the top value of the waveform to the amplitude value.
- 14. Preshoot:** indicates the ratio of the difference between the minimum value and the base value of the waveform to the amplitude value.
- 15. AC RMS:** indicates the root-mean-square value of the waveforms, with the DC component removed. The formula is shown as follows:

$$Std.Dev = \sqrt{\frac{\sum_{i=1}^n (x_i - Average)^2}{n}}$$

Wherein, x_i is the amplitude of the i th point, *Average* is the waveform average value, and n is the number of points being measured.

10.1.5 Other Parameters

- **Positive Slew Rate:** On the rising edge, first calculate the difference between the high value and the low value, then use the difference to divide the corresponding time value to obtain the positive slew rate.
- **Negative Slew Rate:** On the falling edge, first calculate the difference between the low value and the high value, then use the difference to divide the corresponding time value to obtain the negative slew rate.
- **Area:** indicates the area of the whole waveform within the screen. The unit is V*s. The area of the waveform above the zero reference (namely the vertical offset) is positive, and the area of the waveform below the zero reference is negative. The area measured is the algebraic sum of the area of the whole waveform within the screen.
- **Period Area:** indicates the area of the first period of waveform on the screen. The unit is V*s. The area of the waveform above the zero reference (namely the vertical offset) is positive, and the area of the waveform below the zero reference is negative. The area measured is the algebraic sum of the whole period area.

10.2 To Select the Measurement Item

In the **Measure** menu, click or tap **Horizontal**, **Vertical**, or **Other** to go to the desired menu. You can also slide to select the measurement item to enter the corresponding interface. as shown in *Figure 10.4*, *Figure 10.5*, and *Figure 10.6*.

- **Vertical:** Vmax, Vmin, Vpp, Vtop, Vbase, Vamp, Vupper, Vmid, Vlower, Vavg, VRMS, Per. VRMS, AC.RMS, Overshoot, Preshoot, Area, and Period Area.

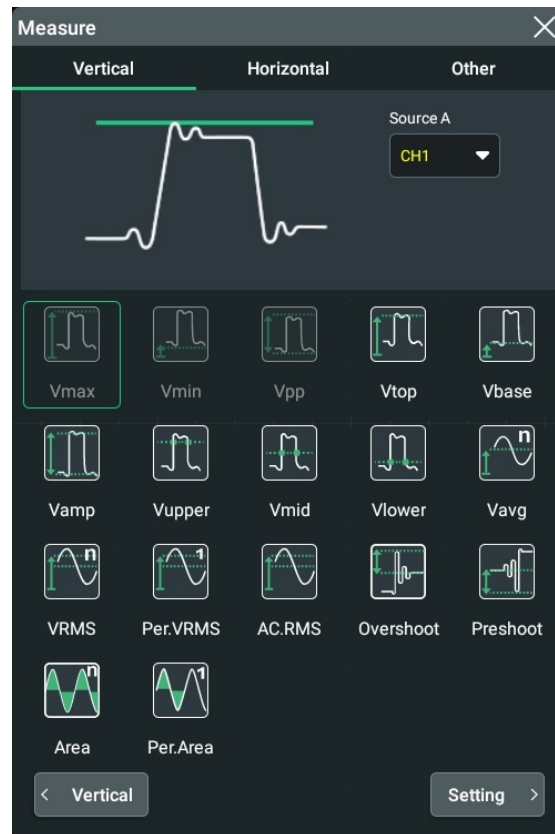

Figure 10.4 Vertical Measurement Items

- **Horizontal:** Period, Frequency, Rise Time, Fall Time, +Width, -Width, +Duty, -Duty, Positive Pulse Count, Negative Pulse Count, Rising Edge Count, Falling Edge Count, T_{vmax}, T_{vmin}, +Slew Rate, and -Slew Rate.

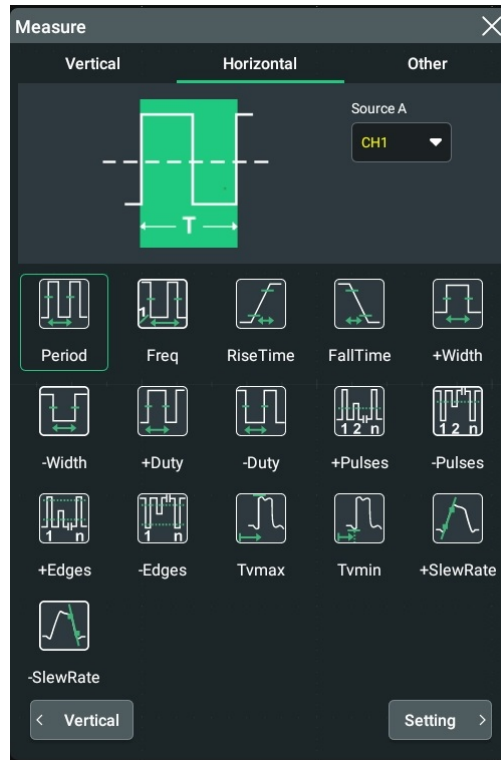

Figure 10.5 Horizontal Measurement Items

- **Other:** Delay (r-r), Delay (r-f), Delay (f-r), Delay (f-f), Phase (r-r), Phase (r-f), Phase(f-r), and Phase (f-f).

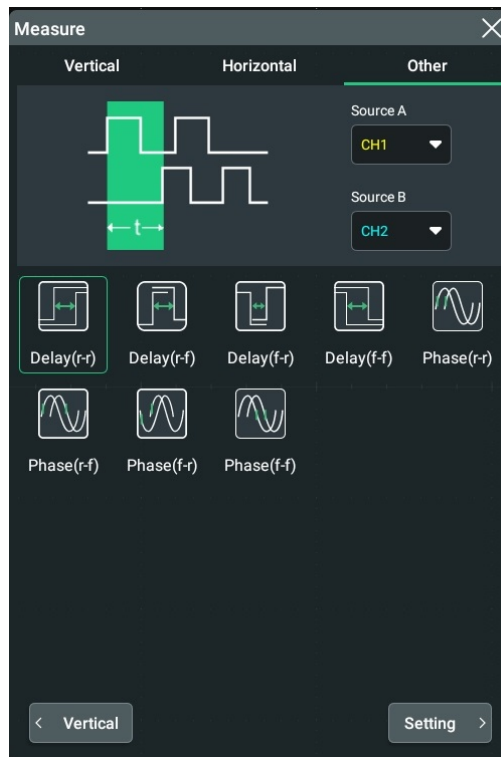

Figure 10.6 Other Measurement Items

10.3 Measurement Settings

In the **Measure** menu, click or tap the **Setting** button to enter the measurement setting menu.

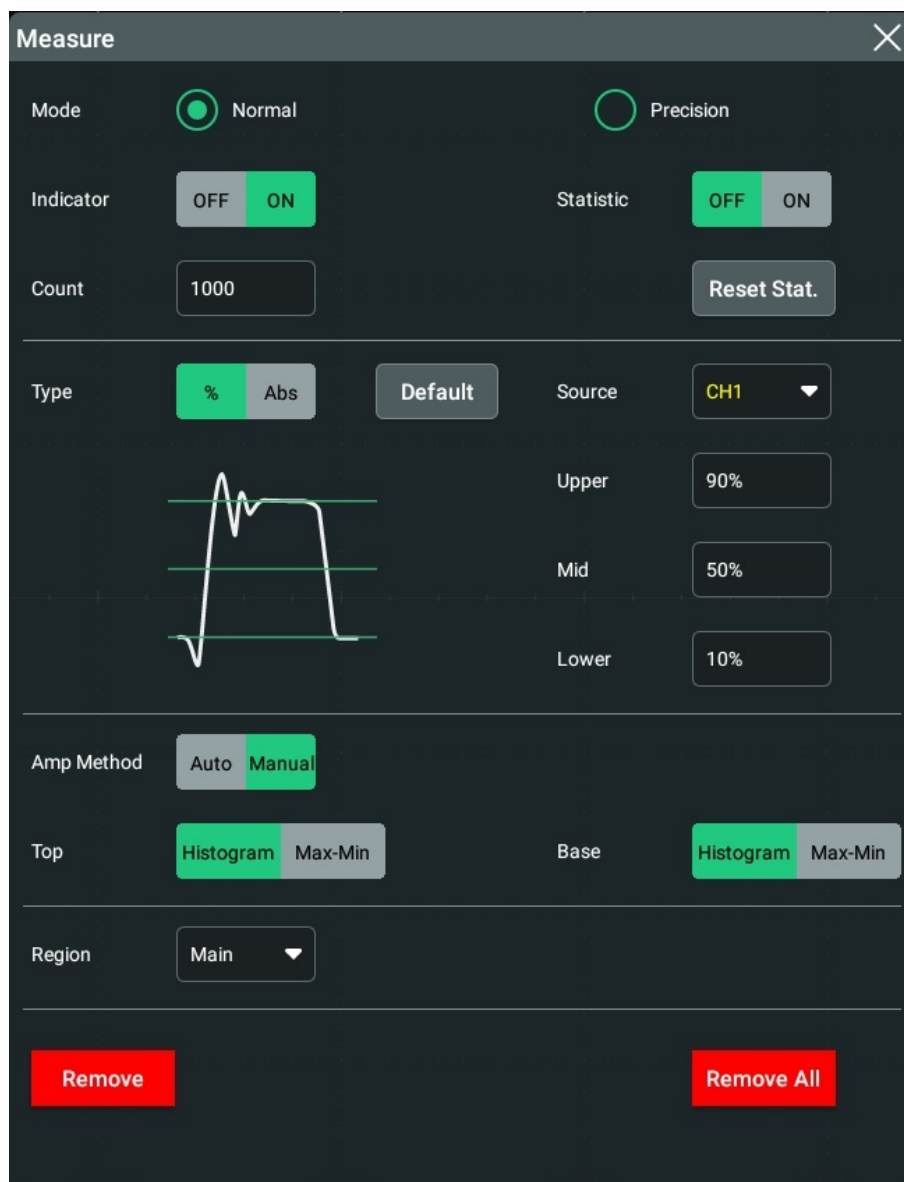

Figure 10.7 Measurement Settings

Measurement Mode

Selects measurement mode: **Normal** or **Precision**.

- **Normal:** executes measurement of up to 1 Mpts.
- **Precision:** executes measurement of up to 200 Mpts, improving the resolution of measurement results. In this mode, the refresh rate of the waveforms may be reduced.

Indicator

In the **Measure** setting menu, click or tap **ON** or **OFF** for the **Indicator** menu item to enable or disable the indicator.

If enabled, one or multiple cursors will be displayed on the screen. Before enabling the indicator, you need to at least enable one auto measurement parameter and the number of cursors will change with the measurement parameter enabled.

Measurement Threshold

- First, click or tap **%** or **Abs** as the display type.
- Click or tap the drop-down button of **Source** to select the desired channel (CH1~CH4 or Math1~Math4).
- Click or tap the input field of **Upper** and use the pop-up numeric keypad to set the upper limit of the measurement. When the upper limit is set to be smaller than or equal to the current middle value, a prompt message "Set at lower limit" is displayed. Then, the oscilloscope will automatically adjust the upper limit and make it greater than the middle value. By default, it is 90%. The default absolute value varies with the vertical setting of the channel.
- Click or tap the input field of **Mid** and use the pop-up numeric keypad to set the middle value of the measurement. The middle value is limited by the settings of the upper limit and lower limit. By default, it is 50%. The default absolute value varies with the vertical setting of the channel.
- Click or tap the input field of **Lower** and use the pop-up numeric keypad to set the lower limit of the measurement. When the lower limit is set to be greater than or equal to the current middle value, a prompt message "Set at upper limit" is displayed. Then, the oscilloscope will automatically adjust the lower limit and make it smaller than the middle value. By default, it is 10%. The default absolute value varies with the vertical setting of the channel.
- Click **Default** to return the upper, middle, and lower limits to their default values.

TIP

Modifying the threshold will affect the measurement results of time, delay, and phase parameters.

Measurement Range

Click or tap the drop-down button of the **Region** menu or "Main".

- **Main:** indicates that the measurement range is within the main time base region.
- **Zoom:** indicates that the measurement range is within the zoomed time base region.



**TIP**

Only when you enable the delayed sweep function first, can "Zoom" be enabled.

Amplitude Measurement Method

Click or tap **Auto** or **Manual** as the amplitude measurement method, which affects the measurement method for the top and base values. If you select "Manual", set the following parameters:

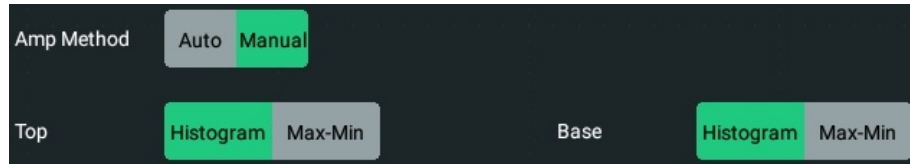

- Under the **Top** menu item, select **Histogram** or **Max-Min** as the top value measurement method.
- Under the **Base** menu item, click or tap **Histogram** or **Max-Min** as the base value measurement method.

**TIP**

If you select "Manual" for the amplitude method, the measurement results of other parameters may be affected.

"Histogram" and "Max-Min" are the internal measurement algorithm for the oscilloscope. The "Histogram" method here is different from the Histogram function of the oscilloscope.



Remove the Measurement Results

Refer to [Remove the Measurement Results](#).

Statistics

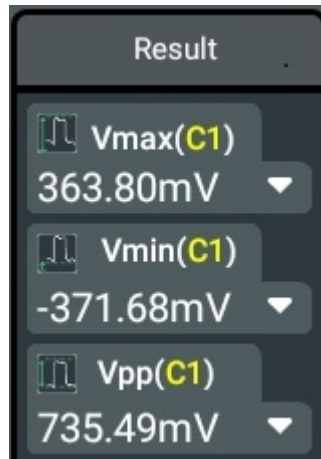
Click or tap the ON/OFF button for the **Statistic** item to enable/disable the statistical function. This oscilloscope can make a statistics and display the current values of the multiple parameters, as shown in the figure below.



- Click or tap **Reset Stat.** to clear the history statistics data and makes statistics again.
- Click or tap the input field of **Count** and use the pop-up numeric keypad to set the count value. Its range is from 2 to 100000. Its default value is 1000.
- Click or tap the icon  at the lower-right corner of the measurement statistics label to unfold the statistics result to display all the measurement statistics items.
Click or tap the icon  to fold the measurement statistics label.

10.4 Remove the Measurement Results

This oscilloscope allows you to delete the measurement results of the parameters.

- In the **Setting** menu, click or tap **Remove** to delete the currently selected measurement item that you've added. Each time you click or tap this button, only one item will be deleted. Each time when one measurement item is selected to be removed, the item following the deleted one under the result list will be moved up.
- Click or tap **Remove All** to delete all the displayed measurement items.
- Click or tap to select the measurement item and drag it to the right to delete it quickly.

10.5 Auto Measurement

When the oscilloscope is correctly connected and has detected a valid input signal,

click or tap the function navigation icon  at the lower-left corner of the screen to select the **Auto** icon to enable the waveform auto setting function and open the auto setting function menu.

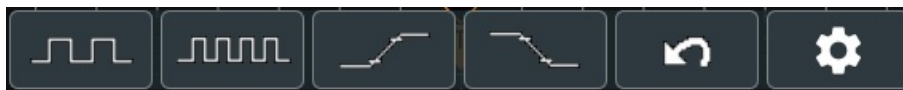

- Click or tap the first icon, and then the single period of the signal is displayed automatically on the screen. Meanwhile, the system will make measurements for the "period" and "frequency" of the currently displayed waveforms in a single period. The measurement results are displayed at the right side of the screen under the "Result" list.
- Click or tap the second icon, and then multiple periods of the signal are displayed automatically on the screen. Meanwhile, the system will make measurements for the "period" and "frequency" of the currently displayed waveforms in a multiple periods. The measurement results are displayed at the right side of the screen under the "Result" list.
- Click or tap the third icon, and then one rising edge of the signal is displayed automatically on the screen. Meanwhile, the system will make measurements for the "rise time" of the currently displayed rising edge. The measurement results are displayed at the right side of the screen under the "Result" list. By default, it is intended for the fast edge signal.
- Click or tap the fourth icon, and then one falling edge of the signal is displayed automatically on the screen. Meanwhile, the system will make measurements for the "Fall time" of the currently displayed falling edge. The measurement results are displayed at the right side of the screen under the "Result" list. By default, it is intended for the fast edge signal.
- Click or tap the fifth icon to cancel the auto setting and recovers to the parameter settings prior to clicking or tapping **Auto**.
- Click or tap the sixth icon to enter the **Auto Config** sub-menu under the **Utility** menu.
 - Click or tap the ON/OFF tab for the **Peak to Peak** menu to enable or disable the peak-peak priority setting. This function is intended for the shifted signal. If there is a large deviation, you can view the signal waveform in priority when you enable the function.
 - Click or tap the ON/OFF tab for the **Live CH** menu to enable or disable testing the enabled channel.
 If you select "OFF", the system will test the 4 analog channels (CH1-CH4) in sequence. If no signal is found on the channel, then the channel is disabled. If a signal is found on the channel, adjust the channel to an optimal scale to display the signal. If you select "ON", the system will only test the enabled channels.
 - Click or tap the ON/OFF tab for the **Overlay** menu to enable or disable the waveform overlay display function. If enabled, waveforms of different

channels will be displayed in the same position of the screen. If disabled, waveforms of different channels will be displayed on the screen from top to bottom in sequence.

- Click or tap ON/OFF tab for the **Coupling** menu to enable or disable the coupling hold function. If enabled, after performing the auto measurement operation, the settings for the channel coupling remain unchanged. If disabled, then the channel coupling is, by default, set to "DC".



TIP

The waveform auto setting function requires that the frequency of the signal should be greater than or equal to 35 Hz, the amplitude greater than or equal to 5 mV. If not meeting the conditions, the waveform auto setting function may be invalid.

10.6 Cursor Measurement

Cursor measurement can measure the X axis values (e.g Time) and Y axis values (e.g. Voltage) of the selected waveform. Before making cursor measurement, connect the signal to the oscilloscope to acquire stable display. All the parameters supported by the "*Auto Measurement*" function can be measured with cursor measurement. The cursor measurement function provides the following two cursors.

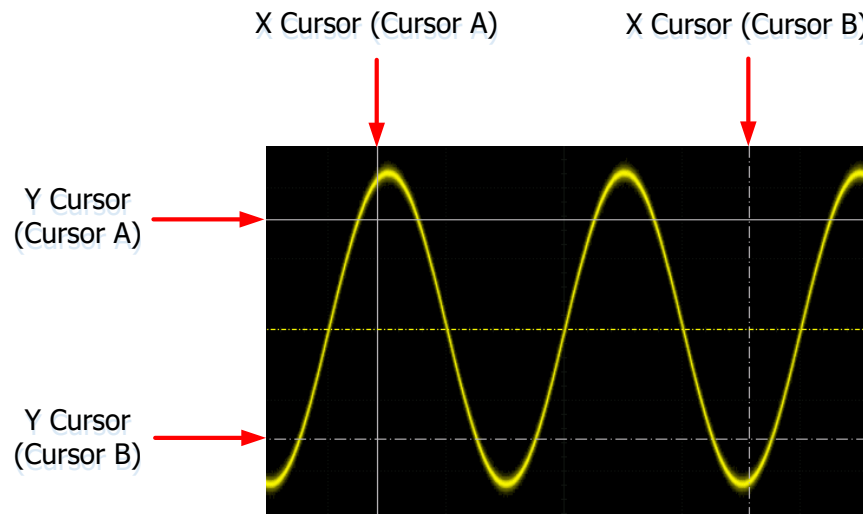





Figure 10.8 Cursor

- **X Cursor**
X cursor is a vertical solid/dotted line that is used to make horizontal adjustments. It can be used to measure time (s) and frequency (Hz).

- Cursor A is a vertical solid line ( is displayed at the bottom of the screen), and Cursor B is a vertical dotted line ( is displayed at the bottom of the screen).
- In the XY cursor mode, X cursor is used to measure the waveform amplitude of CH1.
- **Y Cursor**
Y cursor is a horizontal solid/dotted line that is used to make vertical adjustments. It can be used to measure amplitude (the unit is the same as that of the source channel amplitude).
- Cursor A is a horizontal solid line ( is displayed at the right section of the screen), and Cursor B is a horizontal dotted line ( is displayed at the right section of the screen).
- In the XY cursor mode, Y cursor is used to measure the waveform amplitude of CH2.

Click or tap the function navigation icon  at the lower-left corner of the screen, then select the **Cursors** icon. The **Cursors** measurement results will be displayed in the "Result" list at the right section of the screen.



Figure 10.9 Cursor Measurement Result

- AX: indicates the X value at Cursor A.
- AY: indicates the Y value at Cursor A.
- BX: indicates the X value at Cursor B.
- BY: indicates the Y value at Cursor B.
- ΔX: indicates the horizontal spacing between Cursor A and Cursor B.
- ΔY: indicates the vertical spacing between Cursor A and Cursor B.

- $1/\Delta X$: indicates the reciprocal of the horizontal spacing between Cursor A and Cursor B.

Click or tap the measurement result list, then select **Remove** or **Setting**.

- If you select **Remove**, the current cursor measurement results will be cleared and the instrument will make new measurements. The new measurement results will be displayed at the right side of the screen under the "Result" list.
- Click or tap **Setting**. Then the "Cursors" interface is displayed. You can select the cursor mode: Manual, Track, and XY.

10.6.1 Manual Mode

In the manual cursor mode, you can adjust the cursor manually to measure the value of the waveforms of the specified source at the current cursor. If the settings for the parameter such as the cursor type and measurement source are different, the measurement results will be different for cursor measurement.

In the **Cursors** menu, click or tap **Manual** for the **Mode** item to enable the Manual cursor measurement function. The measurement results are displayed at the right side of the screen under the "Result" list. When you change the cursor position, the measurement results will be changed accordingly.

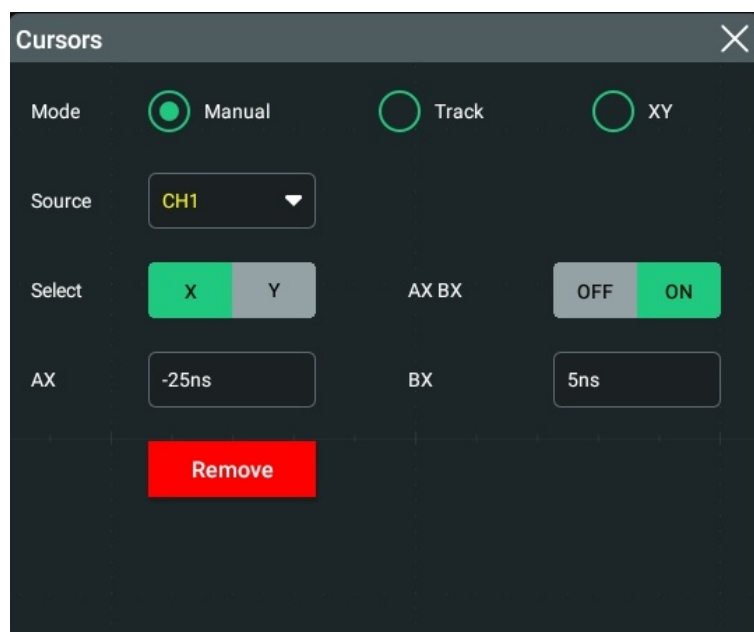

Figure 10.10 Manual Mode Setting Menu

Select Measurement Source

Click or tap the drop-down button of **Source** to select the desired channel (None, CH1~CH4, or Math1~Math4).

If the specified channel is selected as the source, the channel will be enabled automatically.

Select Cursor Type

Click or tap "X" or "Y" under **Select** to select the cursor type.

- **X**: It is a pair of vertical solid (Cursor A)/dotted (Cursor B) lines, used for measuring time parameters. The measurement results include AX, BX, ΔX , and $1/\Delta X$.
- **Y**: It is a pair of horizontal solid (Cursor A)/dotted (Cursor B) lines, used for measuring voltage parameters. The measurement results include AY, BY, and ΔY .

Adjust Cursor Position

1. When "X" is selected under Select, you can adjust the position of X cursor.
 - Click or tap the input field of **AX** and use the pop-up numeric keypad to set the horizontal position of Cursor A (X cursors). The horizontal axis indicates time, and the unit of its setting value is the same as that of the horizontal unit. Its adjustable range is limited within the screen.
 - Click or tap the input field of **BX** and then use the pop-up numeric keypad to set the horizontal position of Cursor B (X cursors). The horizontal axis indicates time, and the unit of its setting value is the same as that of the horizontal unit. Its adjustable range is limited within the screen.
 - Click or tap the ON/OFF tab for the **AX BX** menu item to adjust the horizontal position of Cursor A and Cursor B (X cursors) simultaneously. Its adjustable range is limited within the screen. The horizontal spacing between Cursor A and Cursor B (X cursors) remains unchanged.
2. When "Y" is selected under Select, you can adjust the position of Y cursor.
 - Click or tap the input field of **AY**, and then use the pop-up numeric keypad to set the vertical position of Cursor A (Y cursors). The vertical axis indicates voltage, and the unit of its setting value is the same as that of the vertical unit.
 - Click or tap the input field of **BY**, and then use the pop-up numeric keypad to set the vertical position of Cursor B (Y cursor). The vertical axis indicates voltage, and the unit of its setting value is the same as that of the vertical unit.
 - Click or tap the ON/OFF tab for the **AY BY** menu item to adjust the vertical position of Cursor A and Cursor B (Y cursors) simultaneously. The vertical spacing between Cursor A and Cursor B (Y cursors) remains unchanged.

You can also use the multifunction knob  at the right side of the front panel or tap the screen to adjust the cursor.

Measurement Example

Measure the period of a sine wave by using the manual cursor measurement and auto measurement respectively. The measurement results are both 1 ms.



Figure 10.11 Manual Cursor Measurement Example

Close the Cursor Measurement Result Window

Click or tap **Remove** to close the cursor measurement result display window at the right side of the screen.

10.6.2 Track Mode

In the Track mode, you can adjust the two pairs of cursors (Cursor A and Cursor B) to measure the X and Y values on two different sources respectively. When the cursors are moved horizontally/vertically, the markers will position on the waveform automatically. When the waveform is expanded or compressed horizontally/vertically, the markers will track the points being marked at the last adjustment of the cursors.

In the **Cursors** menu, click or tap **Track** for the **Mode** item to enable the Track cursor measurement function. The measurement results are displayed at the right side of the screen under the "Result" list.

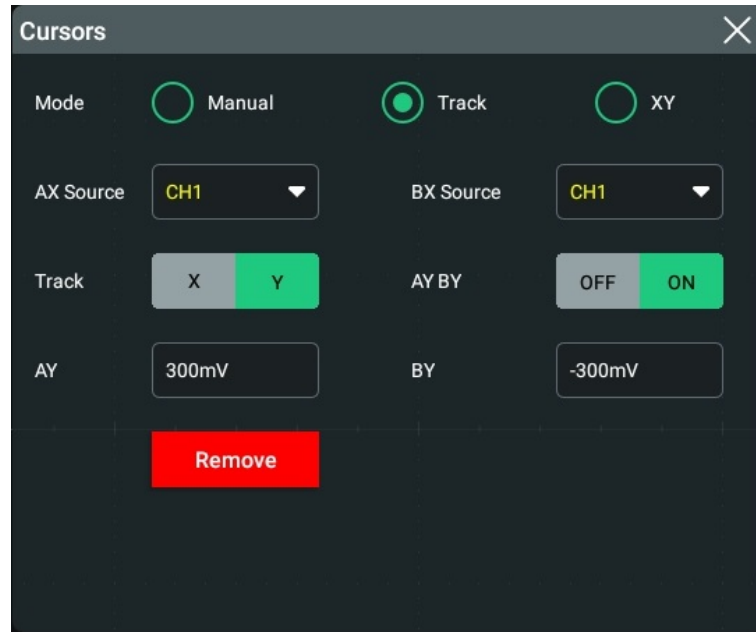

Figure 10.12 Track Mode Setting Menu

Select Measurement Source

- Click or tap the drop-down button of **AX Source** to select the desired channel (None, CH1~CH4, or Math1~Math4).
- Click or tap the drop-down button of **BX Source** to select the desired channel (None, CH1~CH4, or Math1~Math4).

If the specified channel is selected as the source, the channel will be enabled automatically.

Select the Track Mode

Click or tap "X" or "Y" under the **Track** menu item as the current track axis. By default, it is "X".

- **X**: tracks X Cursor and measures the value at X Cursor.
- **Y**: tracks Y Cursor and measures the time of the first point at the left side of the screen.

Adjust Cursor Position

- When "X" is selected for the track mode, you can adjust the position of X cursor.
 - Click or tap the input field of **AX** and use the pop-up numeric keypad to set the horizontal position of Cursor A (X cursor). Its adjustable range is limited within the screen.

- Click or tap the input field of **BX** and use the pop-up numeric keypad to set the horizontal position of Cursor B (X cursors). Its adjustable range is limited within the screen.
- Click or tap the ON/OFF tab for the **AX BX** menu item to adjust the horizontal position of Cursor A and Cursor B (X cursors) simultaneously. Its adjustable range is limited within the screen. The horizontal spacing between Cursor A and Cursor B (X cursors) remains unchanged.
- When "Y" is selected for the track mode, you can adjust the position of Y cursor.
 - Click or tap the input field of **AY** and use the pop-up numeric keypad to set the vertical position of Cursor A (Y cursor).
 - Click or tap the input field of **BY** and use the pop-up numeric keypad to set the vertical position of Cursor B (Y cursor).
 - Click or tap the ON/OFF tab for the **AY BY** menu item to adjust the vertical position of Cursor A and Cursor B (Y cursors) simultaneously. The vertical spacing between Cursor A and Cursor B (Y cursors) remains unchanged.

Measurement Example

Measure the waveforms of CH1 and CH2 with Cursor A and Cursor B, respectively. Then, expand the waveforms horizontally, and you will find that the cursor will track the point that has been marked, as shown in the following figure.

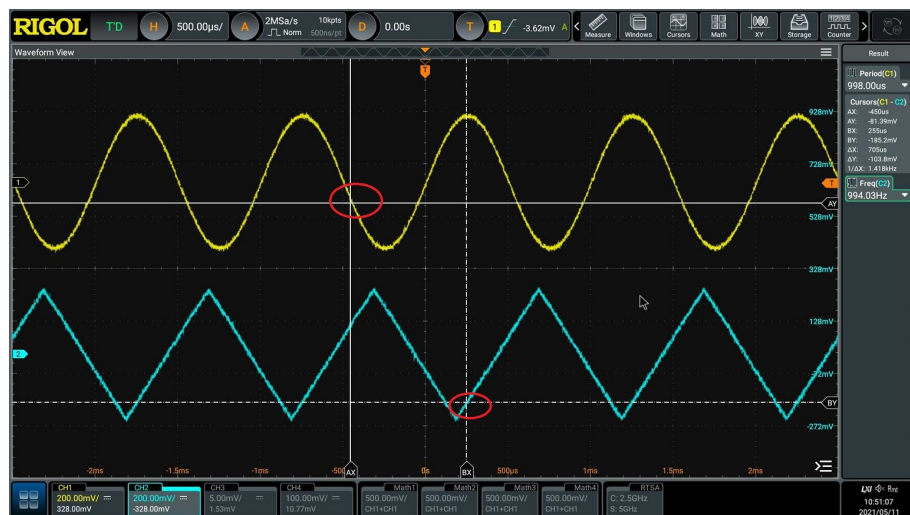

Figure 10.13 Track Measurement (before Horizontal Expansion)



Figure 10.14 Track Measurement (after Horizontal Expansion)

Close the Cursor Measurement Result Window

Click or tap **Remove** to close the cursor measurement result display window at the right side of the screen.

10.6.3 XY Mode

In the **Cursors** menu, click or tap **XY** for the **Mode** item to enable the XY cursor measurement function. The measurement results are displayed at the right side of the screen under the "Result" list.

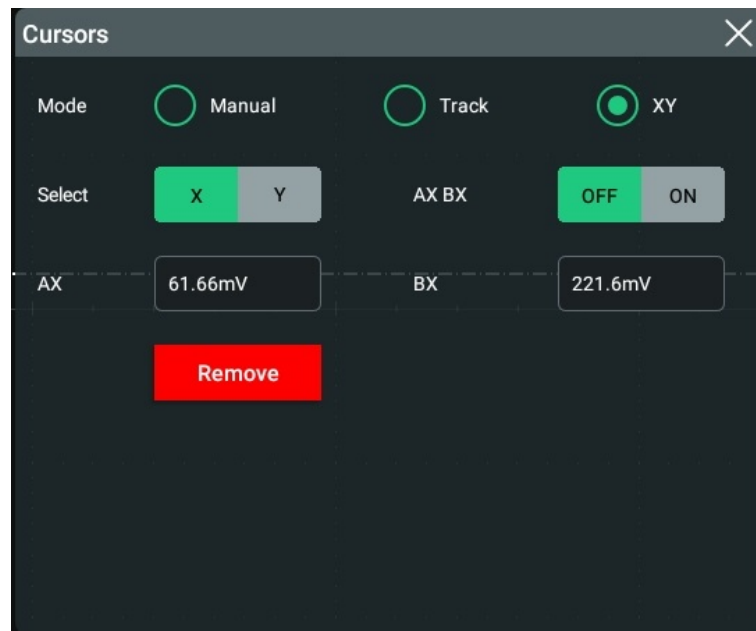

Figure 10.15 XY Mode

**TIP**

By default, XY mode is unavailable. It is only available when the horizontal time base mode is "XY".

To add the XY mode, click or tap the **Windows** icon at the upper-right part of the screen to enter the **Add Window** interface. In the **Diagram** menu, click or tap "XY", and then click or tap **Add** to open the "XY horizontal time base window". Only when you have made such settings, can the **XY** mode be available for the cursor mode under the **Cursors** menu.

Adjust Cursor Position

- Click or tap to select the "X" tab under the **Select** menu item to set the X value for the specified cursor.
 - Click or tap the input field of **AX** and use the pop-up numeric keypad to set the X value at Cursor A.
 - Click or tap the input field of **BX** and use the pop-up numeric keypad to set the X value at Cursor B.
 - Click or tap to select "ON" for the **AX BX** menu item to adjust the X value at Cursor A and the X value at Cursor B simultaneously.
- Click or tap to select the "Y" tab under the **Select** menu item to set the Y value for the specified cursor.
 - Click or tap the input field of **AY** and use the pop-up numeric keypad to set the Y value at Cursor A.
 - Click or tap the input field of **BY** and use the pop-up numeric keypad to set the Y value at Cursor B.
 - Click or tap to select "ON" for the **AY BY** menu item to adjust the Y value at Cursor A and the Y value at Cursor B simultaneously.

During the adjustment, the measurement results will change accordingly. The adjustable range is limited within the screen.

Close the Cursor Measurement Result Window

Click or tap **Remove** to close the cursor measurement result display window at the right side of the screen.

11 Digital Voltmeter (DVM) and Frequency Counter

DS70000 series oscilloscope provides a built-in digital voltmeter (DVM) and frequency counter, which enable you to perform an accurate measurement, improving user experience in counter and frequency measurement.

11.1 Digital Voltmeter (DVM)

The built-in DVM of this oscilloscope provides 3-digit voltage measurements on any analog channel. DVM measurements are asynchronous from the oscilloscope's acquisition system and are always acquiring.

Click or tap the function navigation icon  at the lower-left corner of the screen to enable the DVM measurement menu. You can also click or tap the "DVM" icon at the top of the screen to enable the DVM measurement. At this time, the result list is displayed at the right section of the screen, showing the voltage and mode. As shown in the figure below:

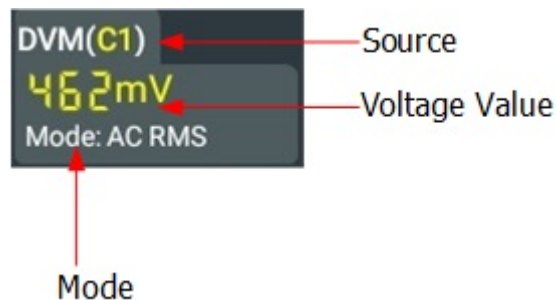

The specific value above shows the measurement extrema over the last 3 seconds.

Click or tap the DVM result list, and then two sub-menus are displayed: **Remove** and **Setting**. Click or tap **Setting** to enter the DVM setting menu.

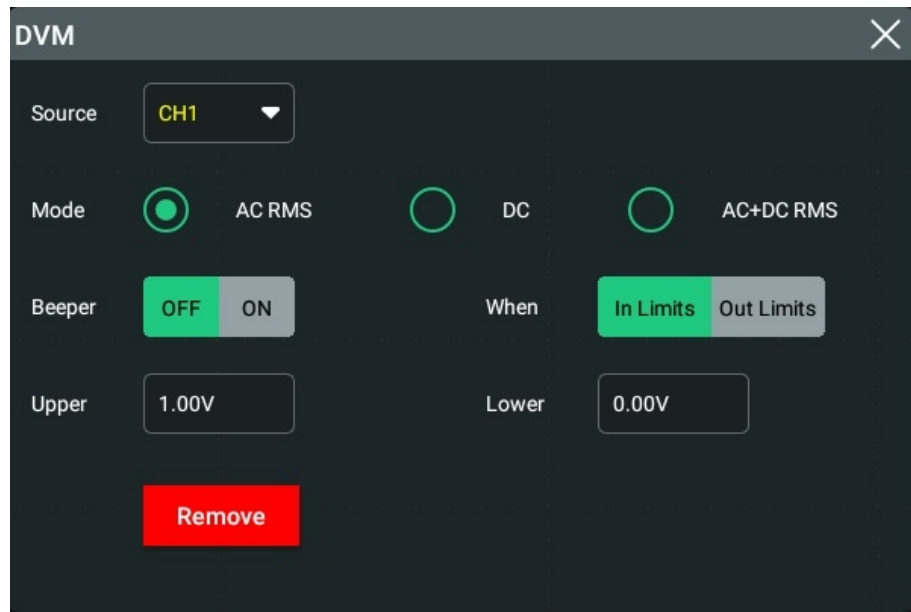

Figure 11.1 DVM Setting Menu

To exit the DVM setting menu, click or tap **Remove** shown at the left side of the DVM result list. You can also click or tap **Remove** in the DVM **Setting** menu.

11.1.1 Measurement Settings

After the DVM is enabled, the DVM result list displayed at the right section of the screen. Click or tap the result list, and then select **Setting**. Then the DVM interface is displayed. You can set the DVM parameters such as measurement source, mode, and limit value setting.

Select Measurement Mode

Click or tap to select the desired mode under the **Mode** menu. The DVM measurement modes include AC RMS, DC, and AC+DC RMS.

- AC RMS: displays the root-mean-square value of the acquired data, with the DC component removed.
- DC: displays the average value of the acquired data.
- AC+DC RMS: displays the root-mean-square value of the acquired data.

Select the Measurement Source

Click or tap the drop-down button of **Source** to select the desired source from the drop-down list. The analog channel (CH1-CH4) can be selected to be the measurement source.

Even if the analog channel (CH1-CH4) is not enabled, you can still perform the DVM measurement.

Set the Limits

When setting the limits, you can select when to turn on or off the beeper once it reaches the limit line.

- Limits Condition Setting

Click or tap to select the desired condition under the **When** menu. The limits conditions include "In Limits" and "Out Limits".

- In Limits: when the voltage value is within the limits, you can enable or disable the beeper to sound an alarm.
- Out Limits: when the voltage value is outside of the limits, you can enable or disable the beeper to sound an alarm.

- Upper/Lower Limit Setting

Click or tap the input field of **Upper**, then use the pop-up numeric keypad to set the upper limit of the voltage.

Click or tap the input field of **Lower**, and then use the pop-up numeric keypad to set the lower limit of the voltage.

11.1.2 Remove the Measurement

Click or tap the DVM result list, and then two menu items are displayed at its left side. Click or tap **Remove** to clear the measurement result. Then the DVM result list is disappeared. You can also click or tap **Remove** in the DVM setting menu shown by clicking or tapping **Setting** at the left side of DVM result list.

11.2 Frequency Counter

The frequency counter analysis function provides frequency, period, or edge event counter measurements on any analog channel.

Click or tap the function navigation icon  at the lower-left corner of the screen to enable the frequency counter. You can also click or tap the "Counter" icon at the top of the screen to enable the frequency counter. At this time, the result list is displayed at the right section of the screen, showing the current measurement results of the frequency counter. As shown in the figure below:

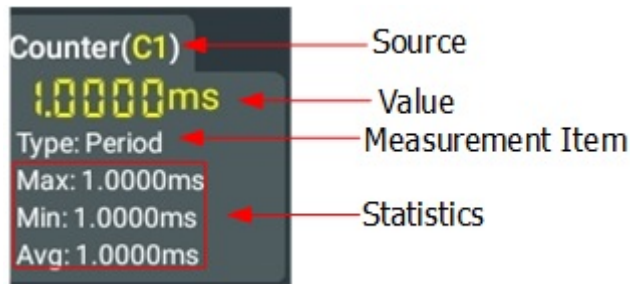

Click or tap the frequency counter result list, and then three sub-menus are displayed: **Reset Stat.**, **Remove**, and **Setting**. To exit the frequency counter setting menu, click or tap **Remove** shown at the left side of the frequency counter result list. You can also click or tap **Remove** in the **Setting** menu of the frequency counter.

11.2.1 Measurement Settings

After the frequency counter is enabled, the frequency counter result list displayed at the right section of the screen. Click or tap the result list, and then select **Setting**. Then the frequency counter interface is displayed. You can set the parameters such as measurement source, measurement item, and resolution.

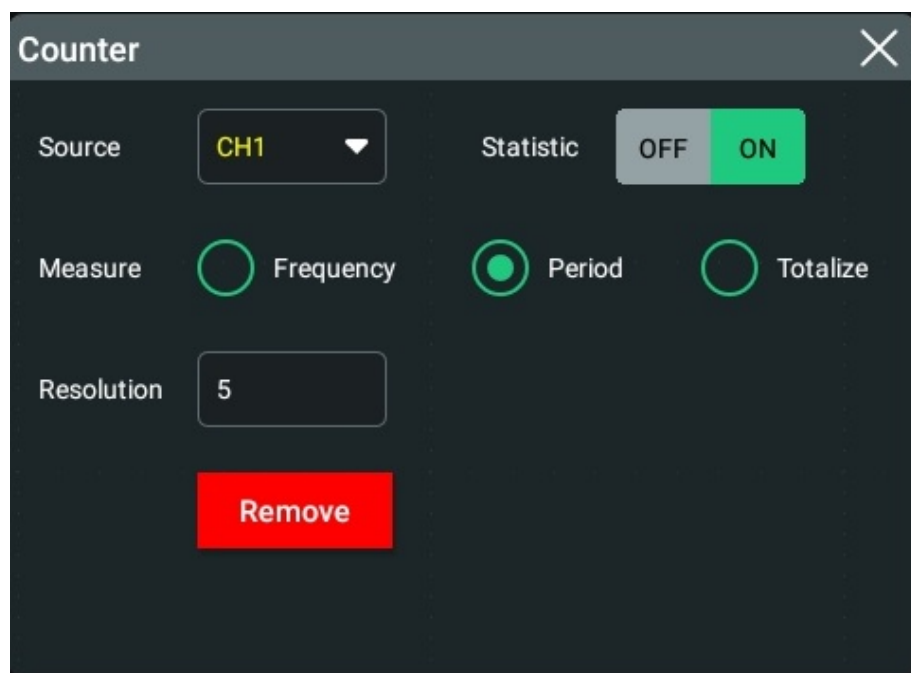

Figure 11.2 Frequency Counter Setting Menu

Select the Measurement Source

Click or tap the drop-down button of **Source** to select the desired source from the drop-down list. Analog channels (CH1-CH4) and EXT can be selected as the source of the frequency counter.

Set Resolution

For Period and Frequency measurements, you need to set the readout resolution. Click or tap the input field of **Resolution** to set the resolution by using the pop-up numeric keypad. The range of resolution is from 3 bits to 8 bits. By default, it is 5 bits.

The greater the resolution, the longer the gate time. In this way, the measurement time will be longer.

Select the Measurement Item

The measurement items supported by the frequency counter of this oscilloscope include Frequency, Period, and Totalize measurements. Wherein, Totalize indicates the count of edge events on the signal.

Select the desired measurement item from the **Measure** menu: Frequency, Period, and Totalize.

Clear Count

When "Totalize" is selected as the measurement item, the oscilloscope measures the count of edge events on the signal. At this time, click or tap **Clear Count** to clear the measurement results.

Statistics Results

Click or tap the ON/OFF button for the **Statistic** item to enable/disable the statistical function. When enabled, all the statistical results will be displayed in the "**Counter**" result list.

11.2.2 Reset Statistics

Click or tap **Reset Stat.** to reset the statistics.

11.2.3 Remove the Measurement

Click or tap the frequency counter result list, and then three menu items are displayed at its left side. Click or tap **Remove** to clear the measurement result. The frequency counter result list disappears. You can also click or tap **Remove** in the counter setting menu shown by clicking or tapping **Setting** at the left side of the frequency counter result list.

12 Real-time Eye Analysis (Option)

The DS70000 series oscilloscope provides the real-time eye plot and measurement with the clock recovery function. If you have purchased and activated the DS70000-JITTA option, the oscilloscope also supports the real-time eye diagram function.

An eye diagram is a view of a signal. A real-time eye accomplishes this by acquiring data, performing clock recovery, then superimposing (folding) successive unit intervals within a single plot. This is a statistical view in the form of a color grade. The eye analysis function is usually used to observe the waveforms of the Receive signal to analyze the impact of inter-symbol interference (ISI) and noise on the system performance.

Click or tap the function navigation icon  at the lower-left corner of the screen to open the function navigation. Then, click or tap the **Eye** icon to enter the "Eye" setting menu. You can also click or tap the "Eye" icon at the top of the screen to enter the "Eye" setting menu.

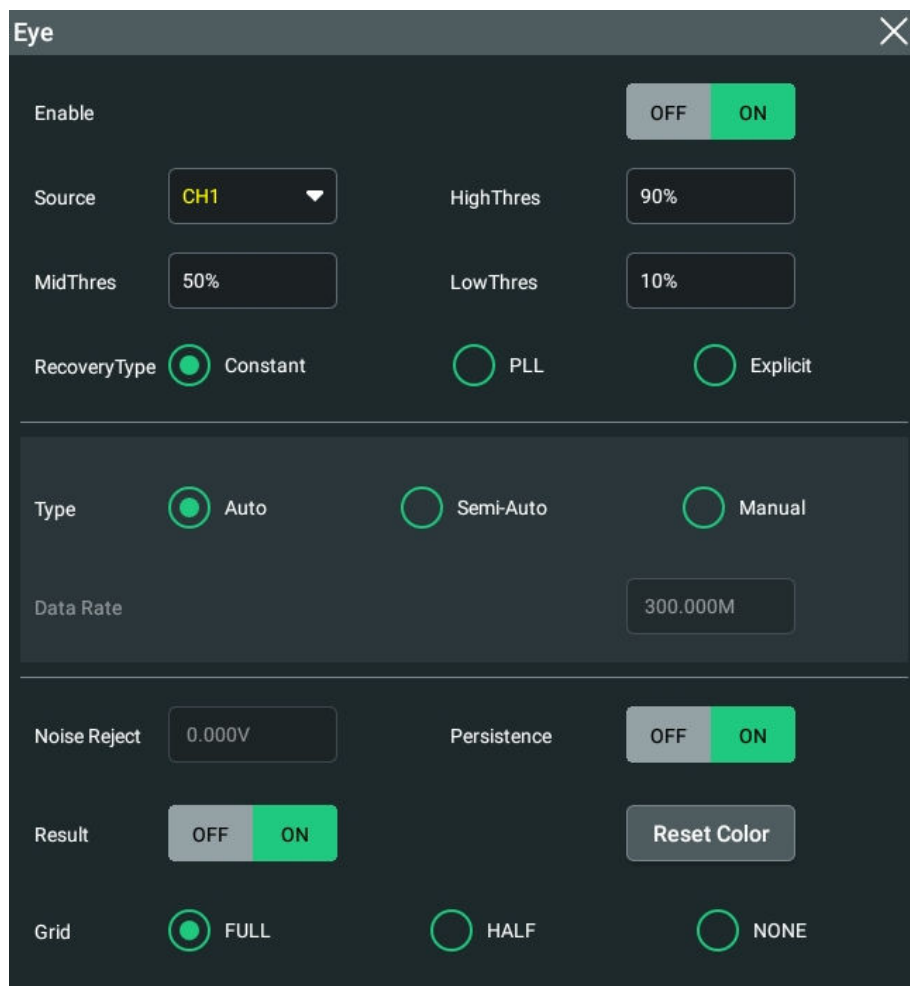

Figure 12.1 Eye Diagram Setting Menu

If you have purchased the DS70000-JITTA option, activate it according the descriptions in *To View the Option Information and the Option Installation*.

12.1 To Enable or Disable the Eye Analysis Function

In the "eye" setting menu, click or tap the ON/OFF tab for the **Enable** menu to enable or disable the eye analysis function. When enabled, the eye diagram window is displayed on the screen.

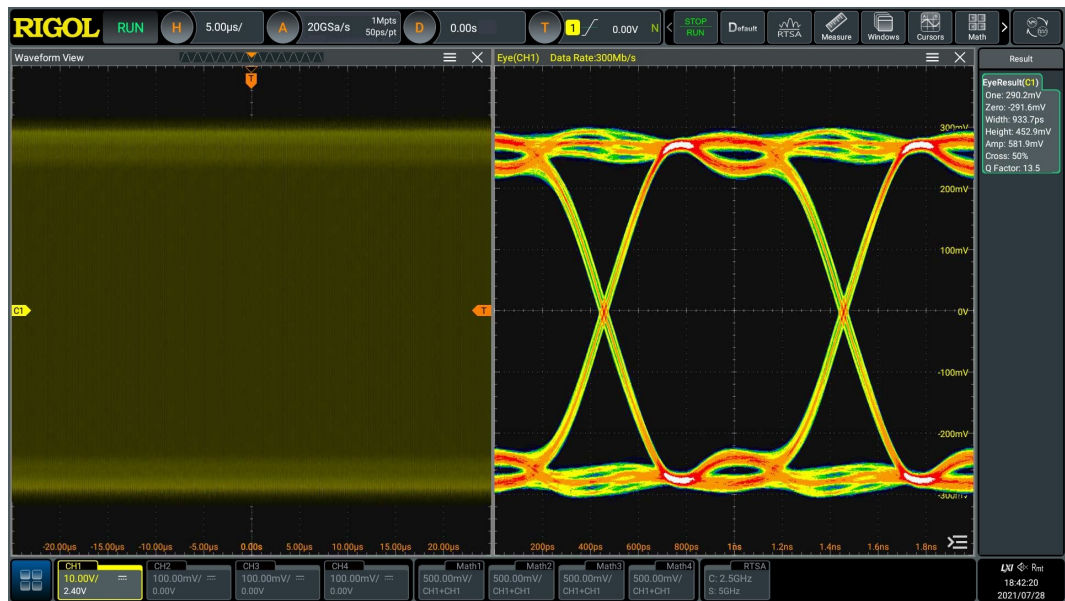

Figure 12.2 Eye Measurement Result



TIP

The eye diagram can only be obtained when the horizontal time base is less than or equal to 1 ms/div.

12.2 To Select the Source of the Eye Diagram

In the "Eye" setting menu, click or tap the drop-down button of **Source** to select the desired source from the drop-down list. The analog channel (CH1-CH4) can be selected to be the eye source.

12.3 Threshold Settings

In the eye setting menu, you can set the high, middle, and low threshold values.

- **Set the High Threshold**

Click or tap the input field of **HighThres**, then use the pop-up numeric keypad to set the high threshold.

If you reduce the high threshold to a value below the set middle threshold, the oscilloscope will adjust the high threshold automatically to make it greater than the middle threshold.

- **Set the Middle Threshold**

Click or tap the input field of **MidThres**, then use the pop-up numeric keypad to set the middle threshold.

The middle threshold is limited by the set low threshold and high threshold.

- **Set the Low Threshold**

Click or tap the input field of **LowThres**, then use the pop-up numeric keypad to set the low threshold.

If you increase the low threshold to a value above the set middle threshold, the oscilloscope will decrease the low threshold automatically to make it smaller than the middle threshold.

12.4 To Set Clock Recovery

The clock recovery provides an ideal clock for comparison to actual signal edges.

In the "Eye" setting menu, click or tap Constant, PLL, or Explicit under the **RecoveryType** menu.

1. Setting Method for Constant Clock Recovery

Click or tap to select "Constant" from the **RecoveryType** menu.

- Set the data rate type.

Click or tap to select the desired data rate type under the **Type** menu. The data rate type for Constant includes Auto, Semi-Auto, and Manual.

- Auto: recovers the clock based on the narrowest pulse of the signal.
- Semi-Auto: recovers the clock by the manually preset data rate and the signal edge.
- Manual: recovers the clock by the data rate input manually.
- Set the data rate

Click or tap the input field of **Data Rate**, then use the pop-up numeric keypad to set the data rate.

2. Setting Method for Phase-Locked Loop (PLL)

Click or tap to select "PLL" from the **RecoveryType** menu.

- Set the data rate

Click or tap the input field of **Data Rate**, then use the pop-up numeric keypad to set the data rate.

- Set the PLL order

This oscilloscope supports first-order PLL and second-order PLL. Select "1st Order" or "2nd Order" from the **PLL Order** menu.

- Set the loop BW

Click or tap the input field of **Loop BW** to set the loop bandwidth by using the pop-up numeric keypad.

- Set the damping factor

When PLL order is set to "2nd Order", you need to set the damping factor. It is the damping factor of the transfer function. Click or tap the input field of **DampFactor** to set the damping factor by using the pop-up numeric keypad.

The typical damping factor is 1.0 and 0.707. The former is critically damped, and the latter is the ideal or optimal value.

3. Setting Method for External Clock Recovery

Click or tap to select "Explicit" from the **RecoveryType** menu.

Click or tap the drop-down button of **Source** to select the desired source from the drop-down list. The analog channel (CH1-CH4) can be selected to be the source of the external clock.

12.5 To Set the Data Rate

In the eye setting menu, you can set the data rate type and data rate.

Type

Click or tap the data rate type: Auto, Semi-Auto, and Manual.

Data Rate

When the data rate type is set to "Semi-Auto" or "Manual", you can set the data rate.

Click or tap the input field of **Data Rate** and use the pop-up numeric keypad to set the data rate. Its range is from 100 k to 4 G. Its default value is 10 M.

12.6 Eye Measurement Result

In the "eye" setting menu, click or tap the ON/OFF tab for the **Result** menu to enable or disable the display of the measurement results. When enabled, the "**Result**" list at the right side of the screen shows the eye measurement result.



- One: indicates "1" level.
- Zero: indicates "0" level.
- Width: indicates the width of an eye diagram.
- Height: indicates the height of an eye diagram.
- Amp: indicates the amplitude of an eye diagram.
- Cross: indicates the crossing percentage of an eye diagram.
- Q Factor: indicates the Q factor.

The diagram of the eye measurement parameters are as shown in the figure below:

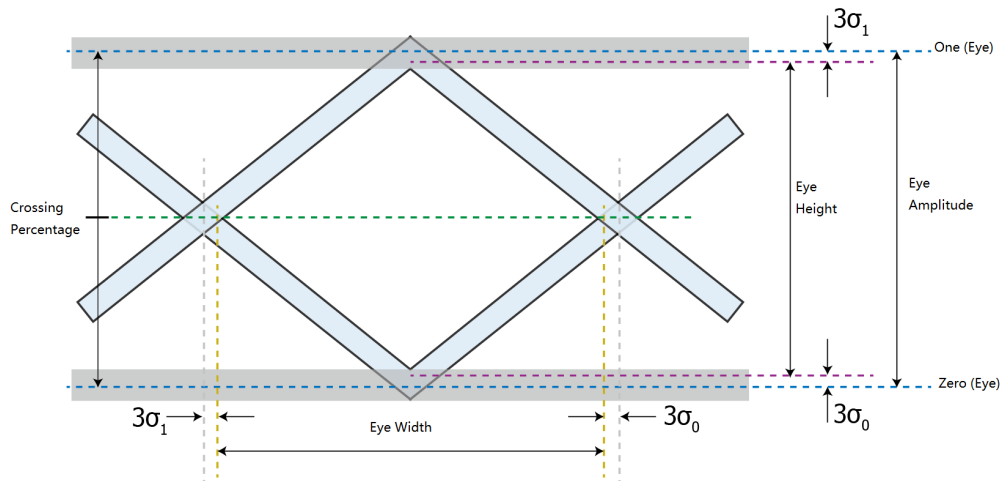

Figure 12.3 Diagram of Eye Measurement Parameters

Click or tap the eye measurement result list, and then two sub-menus are displayed:

Remove and **Setting**.

- Click or tap **Setting**, then the eye diagram menu is displayed, as shown in *Figure 12.1*.
- To close the measurement result list, click or tap **Remove**.

12.7 To Set the Display-related Parameters

Noise Rejection

Noise rejection can eliminate the burst glitch in the actual circuit. The noise rejection is set automatically by the system and cannot be modified manually.

Persistence

Click or tap the ON/OFF tab for the **Persistence** menu to enable or disable the persistence function.

Reset Color

Click or tap **Reset Color** to clear the color level counter.

Grid

Sets the **Grid** of the instrument. For details, refer to *To Set the Screen Grid*.

13 Jitter Analysis (Option)

The jitter analysis function is mainly used to analyze the integrity of the high-speed serial signal and measure the variance of a measurement over time. The measurement items include total jitter (TJ), random jitter (RJ), deterministic jitter (DJ), period jitter (PJ), data-dependent jitter (DDJ), duty cycle distortion (DCD), inter-symbol interference (ISI), and bit ratio (BR).

Click or tap the function navigation icon  at the lower-left corner of the screen to open the function navigation. Then, click or tap the **Jitter** icon to enter the "Jitter" setting menu.

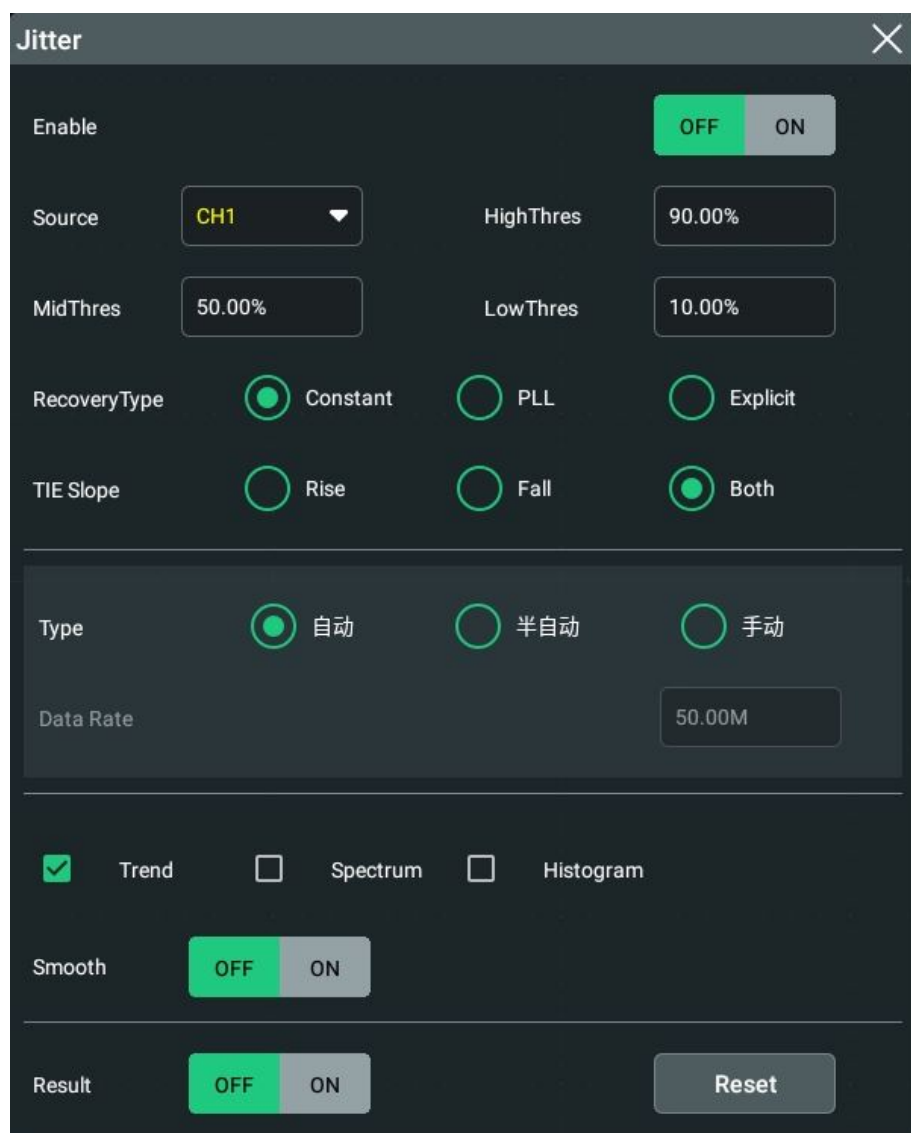

Figure 13.1 Jitter Setting Menu

If you have purchased the DS70000-JITTA option, activate it according the descriptions in [To View the Option Information and the Option Installation](#).

13.1 To Enable or Disable the Jitter Function

In the "jitter" setting menu, click or tap the ON/OFF tab for the **Enable** menu to enable or disable the jitter analysis function. When enabled, the jitter diagram window is displayed on the screen.

13.2 To Set Parameters

In the "Jitter" setting menu, set the following parameters.

Select the Source

Click or tap the drop-down button of **Source** to select the desired source from the drop-down list. The analog channel (CH1-CH4) can be selected to be the jitter source.

Threshold Settings

For details about setting the jitter measurement threshold, refer to *Threshold Settings*.

Set Clock Recovery

For setting methods of the clock recovery in the jitter, refer to descriptions in *To Set Clock Recovery*.

TIE Slope

TIE indicates the time interval error. The TIE measurement compares the edges in a data signal with the edges in an ideal data signal determined by the clock recovery feature to generate error statistics. TIE slope is used to set the edge type.

Set the Data Rate

For the jitter data rate type and data rate, refer to descriptions in *To Set the Data Rate*.

Set the Display Format of the Jitter Measurement Result

The jitter measurement results will be displayed in the jitter window. You can click or tap to select "**Trend**", "**Spectrum**", or "**Histogram**" as the display format.

- **Trend:** The trend graph can display the trend of the jitter measurement results. The data obtained from the waveforms of the same frame are generated to form a curve, which enables users to find out the cause for jitter.

When the clock recovery method is set to "PLL", the PLL system cannot reach the expected ideal clock frequency until it reaches the specified lock time. During the lock time, the TIE jitter measurement results based on the ideal recovery clock are incorrect. The data produced during this time will be discarded in data processing. Therefore, in the TIE jitter trend graph based on the PLL recovery, part of trend graph at the left section of the screen will be lost.

- **Spectrum:** The spectrum graph shows the waveforms of the trend diagram through the FFT (Fast Fourier Transform).
- **Histogram:** The histogram shows the distribution of the jitter measurement results. Wherein, Gaussian distributions indicates random jitter, and non-Gaussian jitter has deterministic components.

Smooth

Click or tap the ON/OFF tab for the **Smooth** menu item to enable/disable the the smooth operation for the jitter.

Reset

Click or tap **Reset**, and then the instrument will restart the jitter measurement.

13.3 To View the Jitter Measurement

In the jitter setting menu, click or tap the ON/OFF tab for the **Result** menu to enable or disable the display of the jitter measurement results. By default, it is OFF. When enabled, the jitter measurement results are displayed at the right side of the screen under the "Result" list.



The measurement results includes the following measurement items:

- **Tj:** indicates the total jitter.
- **Rj:** indicates the random jitter. It is compliant with the Gaussian distribution, and its source can be thermal noise, shot noise, and random noise, with non-stationary interference.
- **Dj:** indicates the deterministic jitter. It has non-Gaussian distribution and is bounded. It is characterized by Gaussian Probability Density Function (PDF) and in scattered distribution. It may be generated due to the bandwidth, reflection, crosstalk, EMI, ground bounce, and period modulation.

- **Pj:** indicates the periodic jitter. The TIE time trend of the periodic jitter is repeated and periodic. It is caused by external deterministic noise sources coupling into a system, such as measuring the periodic waveforms, system clock (with the jitter frequency above MHz level), or switching power supply (with the jitter frequency above KHz level).
- **DDJ:** indicates data-dependent jitter. It refers to any jitter that is correlated with the bit sequence in a data stream. DDJ is often caused by the frequency response of a cable or device.
- **DCD:** indicates duty cycle distortion. It is caused by the asymmetrical rise time and fall time; or the non-optimal choice of reference level. The crossing percentage in the eye diagram is similar to DCD.
- **ISI:** indicates the inter-symbol interference. It is also called data-dependent jitter (DDJ) or pattern-dependent jitter. It is caused by the effects of the transmission link, reflection, etc.

The signal transmits due to unmatched impedance. The transmitted signal is superimposed on the original signal, increasing the signal amplitude, causing more time spent on level conversion. The constant unchanged symbol pattern will reach a higher level, and more time is required to reach the threshold level during hopping, causing signal jitter. As the amplitude of the jitter is related to the pattern, it is also called pattern-dependent jitter (PDJ).

- **BR:** indicates bit ratio.

Click or tap the jitter measurement result list, and then two sub-menus are displayed: **Remove** and **Setting**.

- Click or tap **Setting**, then the jitter diagram menu is displayed, as shown in *Figure 13.1*.
- To close the measurement result list, click or tap **Remove**.

14 Reference Waveform

DS70000 series oscilloscope provides 10 reference waveform positions (Ref1 ~ Ref10). In the actual test process, you can compare the signal waveform with the reference waveform to locate the failure.

14.1 To Enable Ref Function

To enter the **Ref** menu, perform any of the following operations:

- Click or tap the function navigation icon  at the lower-left corner of the screen, and then select **Ref** to enter the reference waveform function menu.
- Tap the **Ref** icon on the small screen at the right side of the screen to enter the reference waveform function menu.

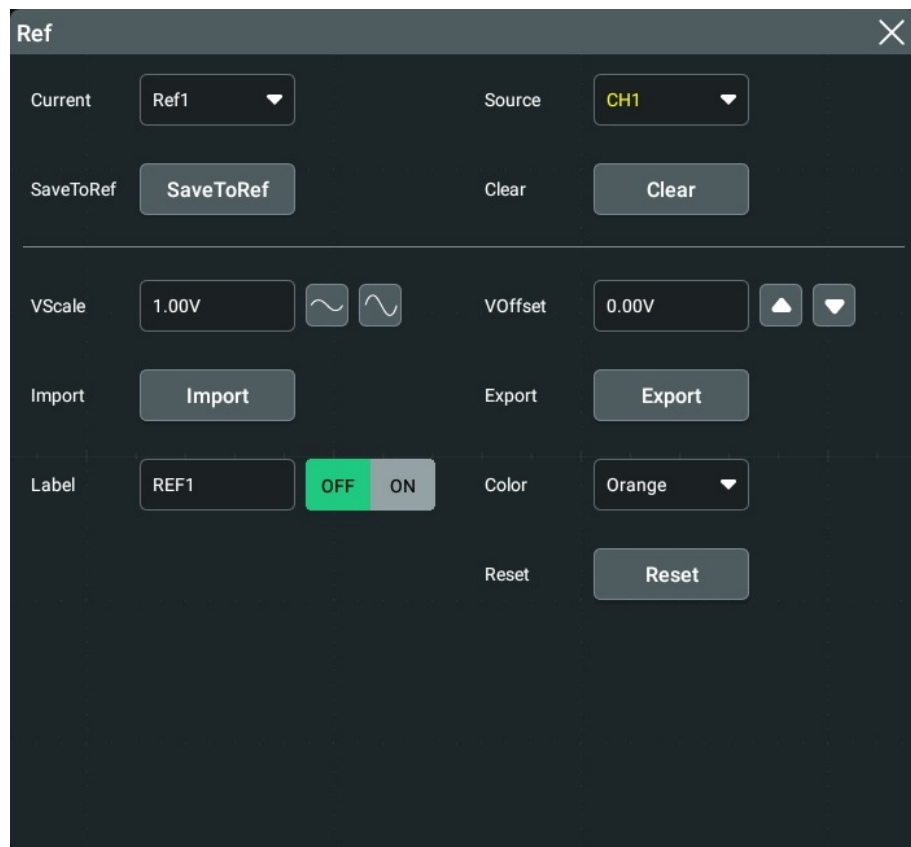

Figure 14.1 Reference Waveform Menu

When the Ref function is enabled, you can select different color for each reference waveform, set the source of each reference channel, adjust the vertical scale and offset of the reference waveform, save the reference waveform to the internal or external memory, and recall it when needed.

14.2 To Set the Reference Waveform

In the **Ref** menu, you can specify a channel to serve as the reference channel. You can save or clear the reference channel.

To Select the Reference Channel

Click or tap the drop-down button of **Current** to select the reference waveform channel (Ref1-Ref10) from the drop-down list. By default, Ref1 is enabled.

To Select the Ref Source

Click or tap the drop-down button of **Source** to select the desired reference waveform source (CH1~ CH4 or Math1~ Math4).

To Save the Reference Waveform to Internal Memory

Click or tap **SaveToRef** to save the displayed waveform for the specified source to the internal memory as the reference waveform.



CAUTION

This operation only saves the reference waveform to the volatile memory, and the waveform will be cleared at power-off or restoring to the default settings.

To Clear the Specified Reference Waveform

Click or tap **Clear** to clear the specified reference waveform for the "**current channel**".

You can also click or tap the "Clear" icon in the function navigation menu or the **Clear** icon on the small screen to clear the reference waveforms of all the reference channels.

14.3 To Set the Ref Waveform Display

After clicking or tapping **SaveToRef** to save the reference waveform to the internal memory, you can adjust the vertical scale and offset of the reference waveform specified under **Current**.

Modify the Vertical Scale

Click or tap the input field of **VScale**, and then use the pop-up numeric keypad to set the vertical scale of the reference waveform. You can also directly click or tap the icon



at the right side of the input field of **VScale** to increase or decrease the vertical scale value. As shown in the figure below:

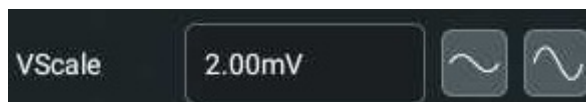

Modify the Vertical Offset

Click or tap the input field of **VOffset**, and then use the pop-up numeric keypad to set the vertical offset of the reference waveform. You can also directly click or tap the

Up and Down arrow icon  at the right side of the input field of **VOffset** to increase or decrease the vertical offset value. As shown in the figure below:



Restore the Reference Waveform

If you have adjusted the vertical scale and offset for the specified reference waveform of the current channel, to reset the reference waveform to the position where the source channel stays prior to the **Save** operation, click or tap **Reset**.

Set the Reference Waveform Color

DS70000 series oscilloscope provides five colors (gray, green, light blue, red, and orange) to mark the reference waveforms of different channels in order to distinguish them.

Click or tap the drop-down button of **Color** to select the color of the reference waveform of the channel.

Set the Reference Waveform Label

Click or tap the ON/OFF tab for the **Label** menu to enable or disable the label display of the specified reference waveform.

Click or tap the input field of "Label" to set the label of the specified reference channel with the pop-up numeric keypad.

14.4 Export and Import Operation

To Export to Internal or External Memory

You can save the current reference waveform to the internal memory or external USB storage device. The file format of the reference waveform is "*.ref", "*.bin", or "*.csv".

Click or tap **Export** to enter the reference waveform file saving interface.

- **Set the Format**

In the file saving interface, click or tap the drop-down button of **Format** to select "*.ref", "*.bin", or "*.csv" as the saving format.

- **Set the Filename**

Click or tap the input field of **File Name**, then the filename editing interface is displayed. Input the filename with the pop-up numeric keypad.

For the methods of using the numeric keypad, refer to descriptions in *Parameter Setting Method*.

- **Set the Save Path**

Click or tap the input field of **File Path**, then the disk management interface is displayed. The interface is shown in the following figure:

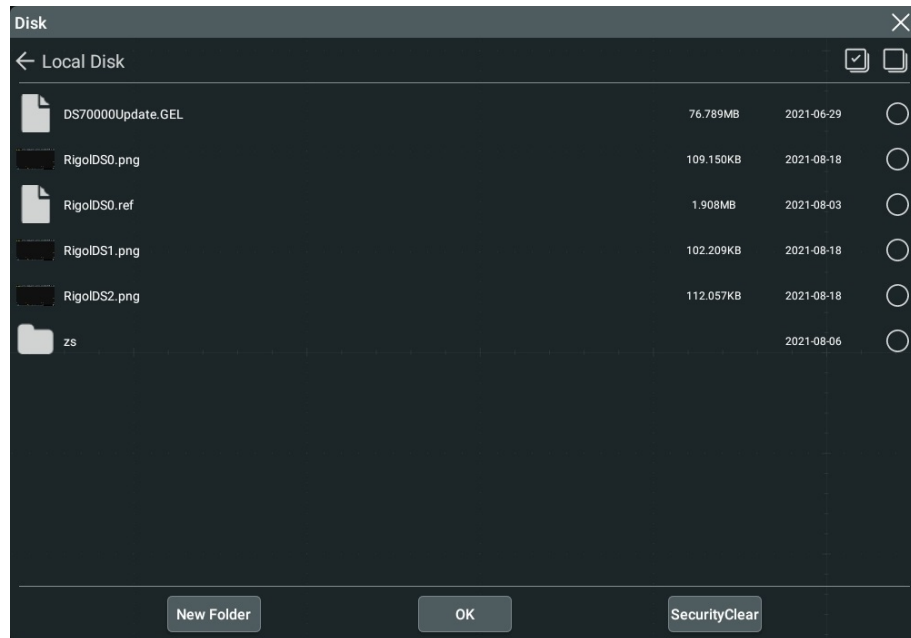

Figure 14.2 Disk Management Interface

Through the disk management menu, you can save the current reference waveform to the internal memory or external USB storage device. Only when the reference waveform is saved, can this export function be valid. For details about the disk management operation, refer to the *Disk Management* section in *Storage*. Then, click or tap **Save** to complete the save operation.



TIP

DS70000 series oscilloscope only supports the flash memory USB storage device of FAT32 format.

For the "*.bin" format file, refer to *Binary Data Format (.bin)*.

To Import from Internal or External Memory

You can import the stored reference waveform file from the internal memory or external USB storage device to the internal instrument and display the file on the screen.

Click or tap **Import** to enter the reference waveform file loading interface.

- **Set the Format**

In the file loading interface, click or tap the drop-down button of **Format** to select "*.ref" as the loading format.

- **Set the Load Path**

Click or tap the input field of **File Path**, then the disk management interface is displayed.

Through the disk management menu, you can load the current reference waveform to the waveform view of the oscilloscope. For details about the disk management operation, refer to the *Disk Management* section in *Storage*. Then, click or tap **Load** to complete the load operation.

15 Pass/Fail Test

During the product design and manufacturing process, you usually need to monitor the variations of the signal or judge whether the product is up to standard. The pass/fail test function of DS70000 series oscilloscope can accomplish this task perfectly.

To enter the Pass/Fail menu, perform any of the following operations:

- Click or tap the function navigation icon  at the lower-left corner of the screen to open the function navigation. Then, click or tap the **Pass/Fail** icon to enter the "Pass/Fail" setting menu.
- You can also tap the **Pass/Fail** icon on the small screen to enter the "Pass/Fail" setting menu.

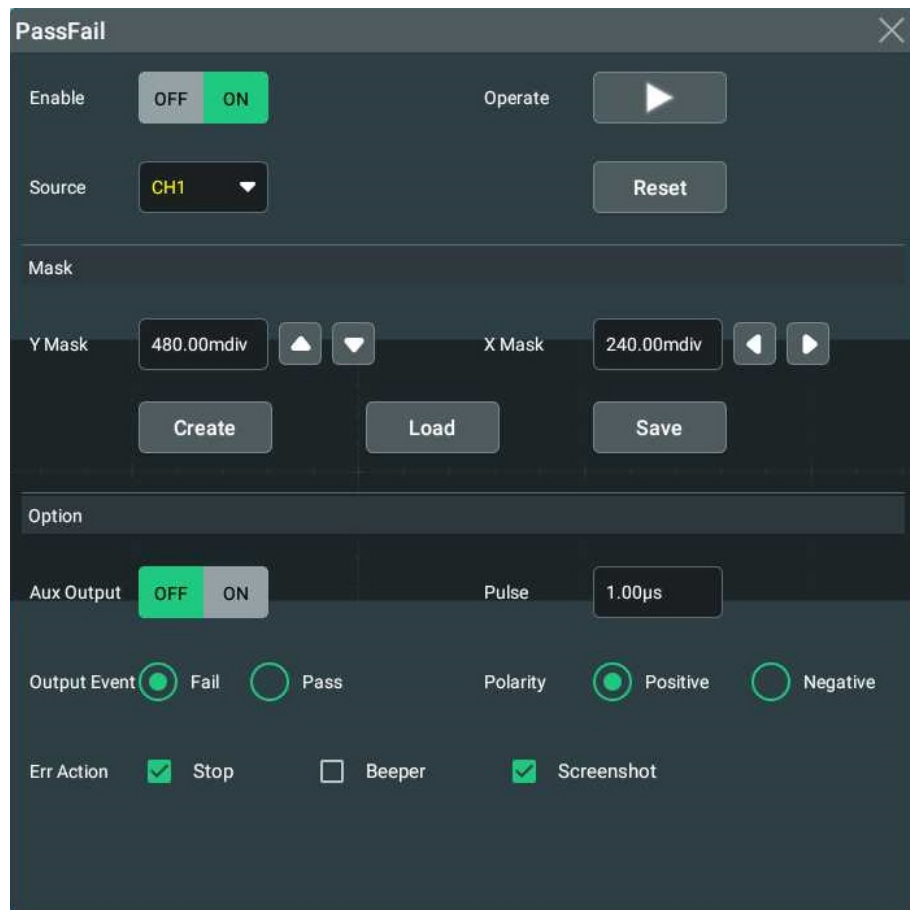

Figure 15.1 Pass/Fail Test Menu

15.1 To Enable or Disable the Pass/Fail Test Function

In the "Pass/Fail" setting menu, click or tap the ON/OFF tab for the **Enable** menu to enable or disable the pass/fail test function.

15.2 To Start or Stop the Pass/Fail Test Operation

After the Pass/Fail test function is enabled, click or tap **Operate** to start or stop the test operation.

During the test process, the oscilloscope will test the waveforms, display the test information, and output the test information based on the current of settings. You can set the test mask, the display status of the test information, and the output form of a pass/ failed test based on the selected source channel for the test. Then save the test mask range to the internal or external memory, and then recall it when needed.

TIP

- Only when the pass/fail test function is enabled, can you start or stop the pass/fail test operation, save and recall the test mask range.
- After starting the test operation, you can neither modify the source channel nor adjust the test mask.

The "**Pass/Fail**" result will be displayed at the right side of the screen under the "**Result**" list.

15.3 To Select the Source

Click or tap the drop-down button of **Source** to select the desired source from the drop-down list. The available output channels include CH1-CH4.

15.4 Mask

In the **Pass/Fail** menu, You can self-define the mask of the pass/fail test.

To Create a Mask

Click or tap **Create** to self-define the mask of the pass/fail test.

Click or tap **X Mask** and **Y Mask** respectively to set the horizontal tolerance range and vertical tolerance range with the pop-up numeric keypad. Then click or tap **Create** to apply the currently created mask (the region not covered by blue within the screen).

To Load a Mask

When the pass/fail test function is enabled, you can load the test mask files from the internal memory or external USB storage device (when detected) and apply them to the current pass/fail test function.

Click or tap **Load** to enter the file loading interface. Click or tap the input field of **File Path** to load the specified test mask files (in *.pf format) and apply them to the current pass/fail test function. For details, refer to descriptions in *Disk Management* section in *Store and Load*.

Save the Mask

When the pass/fail test function is enabled, you can save the current test mask range to the internal memory or external USB storage device (when detected) in "*.pf" format.

Click or tap **Save** to enter the file saving interface. Click or tap the input field of **File Name** and **File Path** to input the filename and select the desired file path to save the test mask file to the internal or external memory. For details, refer to descriptions in *Disk Management* section in *Store and Load*.

15.5 To Set the Output Form of the Test Results

In the **Option** menu, you can set what the oscilloscope will execute when test results are detected according to your needs.

Set the output event and Aux output

- Click or tap the ON/OFF tab for the **Aux Output** to enable or disable the Aux output. When enabled, in the **Utility** menu, the sub-menu **AUX Out** is automatically set to "PassFail". When a successful or failed event test is detected, a pulse will be output from the **[AUX OUT]** connector. If disabled, the sub-menu **AUX Out** is automatically set to "TrigOut", and the output of the **[AUX OUT]** connector is irrelevant with the pass/fail test.
- Click or tap "Pass" or "Fail" under **Output Event**.

Set the output polarity and output pulse width

Click or tap "Positive" or "Negative" under **Polarity**, then click or tap the input field of **Pulse** to set the pulse width. Its range is from 100 ns to 10 ms. By default, it is 1 μ s.

Set the error action

Click or tap the check box of **Err Action** to select one operation that the oscilloscope will execute once a pass/fail test is detected.

- **Stop:** indicates stopping sampling when a failed event is found.
- **Beeper:** indicates that the beeper sounds an alarm when a failed event is found (irrelevant with the on/off status of the beeper).
- **Screenshot:** performs the screenshot operation when a failed event is found. If an external storage device is detected, the screenshot will be saved to the external storage device directly. Otherwise, it will be saved to the local disk.

If "Screenshot" is selected, "Stop" action will be executed forcibly. The sampling will be stopped automatically. After the Screenshot operation is completed, the sampling will continue.

15.6 Display of the Statistics of the Test Results

After the "Pass/Fail" function is enabled, the test result list will be displayed at the right side of the screen. You can click or tap the icon  at the lower-right corner of the screen to hide the test result list.

The test results statistics include the number of failed frames, the number of successful frames, and total number of frames, as shown in the figure below.

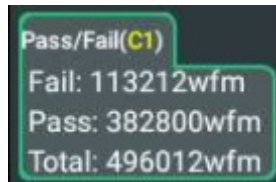

Click or tap "Pass/Fail" test result list, the following menu items can be displayed and you can perform the following operations.

- Click or tap **Reset Stat.**, then the statistics in the "Pass/Fail" test result list will be reset to 0.
- Click or tap **Setting**, then the **PassFail** setting interface is displayed.
- Click or tap **Remove**, then the pass/fail function is disabled.

16 RTSA (Option)

DS70000 supports RTSA. To enter the **RTSA** menu, perform any of the following operations:

- Click or tap the function navigation icon  at the lower-left corner of the screen, and then select **RTSA** to open the RTSA measurement display window and enter the RTSA function menu.
- Click or tap the **RTSA** icon in the quick operation menu bar at the top of the screen to open the RTSA measurement display window and enter the RTSA function menu.
- Click or tap the RTSA information label at the bottom of the screen to open the RTSA measurement display window. Click or tap the label again to enter the RTSA function menu.

In RTSA, you can set AMPT, BW, FREQ, and SPAN parameters. You can also search the peak according to the set parameters.

If you have purchased the DS70000-RTSA option, activate it according the descriptions in *To View the Option Information and the Option Installation*.

16.1 Basic Settings

In **RTSA** menu, click or tap the **Basic** tab, then you can set the relevant parameters.

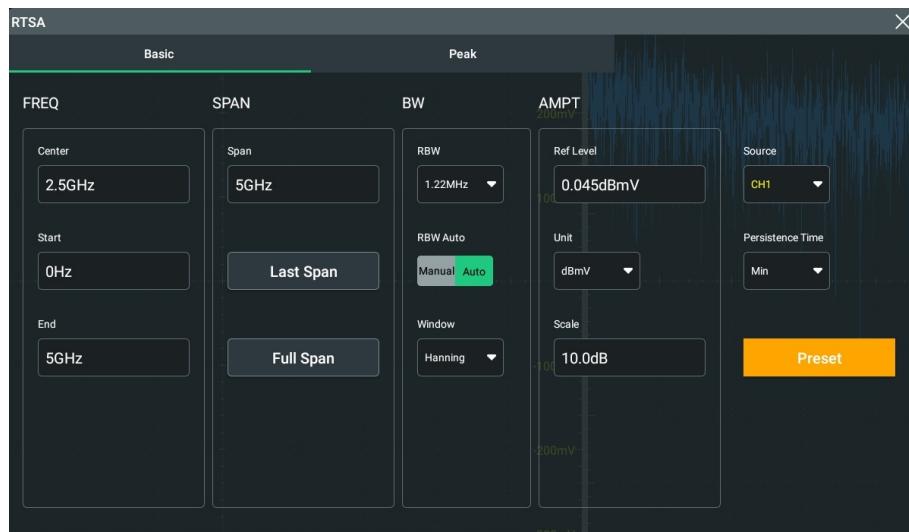

Figure 16.1 Basic Setting Menu

To Set the Source

Click or tap the drop-down button of **Source** to select the desired source from the drop-down list. The available sources for RTSA include **CH1-CH4**.

Preset

Click or tap **Preset**, and all the configurations in the RTSA menu will be restored to the default settings.

Persistence Time

Click or tap the drop-down button of **Persistence Time** to select the persistence time from the drop-down list. The available choices include Min, 100 ms, 200 ms, 500 ms, 1 s, 2 s, 5 s, 10 s, and Infinite. By default, it is Min and the persistence function is disabled.

16.1.1 **FREQ**

In RTSA, the frequency range of a channel can be expressed by either of two groups of parameters: Start Frequency/Stop Frequency; Center Frequency/Span.

Sets the frequency range of RTSA. Each time the parameters are modified, the instrument restarts to sweep.

The frequency range of a channel can be set by either of two groups of parameters:

- Start Frequency/Stop Frequency (f_{start}/f_{stop})
- Center Frequency/Span (f_{center}/f_{span})

If any of the four parameters is changed, the other three parameters will make adjustment automatically to ensure the coupling relationship among them:

$$f_{center} = (f_{start} + f_{stop})/2$$

$$f_{span} = f_{stop} - f_{start}$$

Center Freq

Click or tap the input field of **Center**, and use the pop-up numeric keypad to set the center frequency. Its range is from 5.00 kHz to 5.00 GHz. Its default value is 2.5 GHz.

- In **SPAN**, when you modify the center frequency, the start and stop frequency will be modified automatically if the **Span** value remains unchanged.
- Modifying the center frequency indicates that the frequency is changed along the current channel horizontally, and the adjustable range should be within the frequency range specified in the technical specifications of the instrument.

Start Freq

Click or tap the input field of **Start**, and use the pop-up numeric keypad to set the start frequency. The minimum value is 0.00 Hz. After configuration, the scale value at the bottom of the RTSA measurement window will be changed accordingly.

When you modify the start frequency, the span and center frequency will be changed. The changes of span will affect other system parameters. For details, please refer to the **Span** description in *SPAN*.

Stop Freq

Click or tap the input field of **End**, and use the pop-up numeric keypad to set the stop frequency. The Max. value is 5.00 GHz. After configuration, the scale value at the bottom of the RTSA measurement window will be changed accordingly.

When you Data stop frequency, the span and center frequency will be changed. The changes of span will affect other system parameters. For details, please refer to the **Span** description in *SPAN*.

16.1.2 SPAN

Span indicates the frequency span measured within the RTSA measurement window range. When you modify the span, the start frequency, the center frequency, and stop frequency will be modified automatically. For details, refer to *FREQ*. After setting the span, the sweep restarts.

Set the Span

Click or tap the input field of **Span**, and then use the pop-up numeric keypad to set the span. Its range is from 10.00 kHz to 5.00 GHz. When the span is set to a maximum value, the instrument enters full span mode.

Last Span

Click or tap **Last Span** to set the span to its last set value.

Full Span

Click or tap **Full Span**, and the span is set to its maximum value.

16.1.3 BW

Under the BW menu, you can set the parameters such as resolution bandwidth (RBW) and window.

Set RBW

RBW indicates the resolution bandwidth. It is used to distinguish two signals whose frequencies are close with each other. Reducing RBW can gain a higher frequency resolution, but will also prolong the sweep time.

Click or tap the drop-down button of **RBW** to select the RBW value from the drop-down list. The available values include 152.59 kHz, 305.18 kHz, 610.35 kHz, 1.22 MHz, 2.44 MHz, 4.88 MHz, 9.77 MHz, and Auto. By default, it is 1.22 MHz. When "Auto" is selected, the instrument will generate a value not available in the current drop-down list based on the current configurations.

RBW Mode

Click or tap "**Manual**" or "**Auto**" under **RBW Auto**.

- **Manual:** selects the desired value from the drop-down button of **RBW**.
- **Auto:** selects a proper value automatically from the available values (e.g. 152.59 kHz, 305.18 kHz, 610.35 kHz, 1.22 MHz, 2.44 MHz, 4.88 MHz, and 9.77 MHz) of the drop-down list of **RBW**. When Auto is selected for RBW mode, the value of **RBW** may be changed.

Set Window Function

Click or tap the drop-down button of **Window** to select the type of the window function. The available window type includes Hanning, Rectangular, Blackman-Harris, Hamming, Flattop, and Triangle. By default, it is Hanning. For details, refer to descriptions in *Window Function*.

16.1.4 AMPT

You can modify AMPT parameters to make the signals under test be displayed with minimal errors in the current window, easy for you to observe.

Set the Reference Level

Click or tap the input field of **Ref Level** to set the reference level with the pop-up numeric keypad. Its range and default value are related to the actually input source.

After configuring the reference level, the vertical axis of RTSA measurement result display window changes according to the configuration. The value of **Scale** also changes with the modification of **Ref Level**.

Set the Reference Level Unit

Click or tap the drop-down button of **Unit** to select the reference level unit from the drop-down list. The available units include dBmV, dB μ V, and Volts. By default, it is dBmV. Wherein, dBmV and dB μ V are for Log scale; Volts is for Linear scale.

The conversion relations between units are as follows (R indicates reference impedance):

$$dBm = 10 \lg \left(\frac{\text{Volts}^2}{R} \times \frac{1}{0.001W} \right)$$

$$dB\mu V = 20 \lg \left(\frac{\text{Volts}}{1\mu V} \right)$$

$$dBmV = 20 \lg \left(\frac{\text{Volts}}{1mV} \right)$$

$$\text{Watts} = \frac{\text{Volts}^2}{R}$$

Set the Scale

Click or tap the input field of **Scale** to set the scale with the pop-up numeric keypad. Its range is from 100.00 mdB to 20.00 dB. By default, it is 10.00 dB.

After configuring the scale value, the vertical axis of RTSA measurement result display window changes according to the configuration. The value of **Ref Level** also changes with the modification of **Scale**.

16.2 Peak Search

The peak search function enables the marker to move to the specific signal peak point, and then in combination with the function of Delta marker, it can provide a powerful analysis capability.

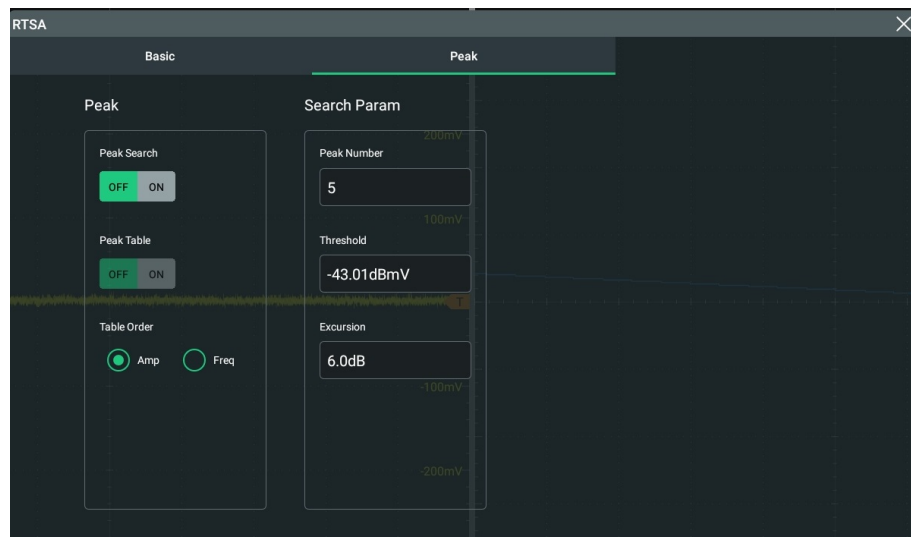

Figure 16.2 Peak Search Menu

Enable the peak search function

Click or tap the ON/OFF button for the **Peak Search** menu to enable or disable the display of the peak search window. By default, it is OFF.

Set the peak search result list

Click or tap the ON/OFF tab for the **Peak Table** menu to enable or disable the display of the peak table. By default, it is OFF.

When the peak table is turned on, the RTSA display window is split into a measurement window and a peak table display window. The peak table will be displayed at the lower section of the screen, displaying the searched parameters (frequency and amplitude) that meet the criteria.

Click or tap "**Amp**" or "**Freq**" as a sorting rule for **Table Order**.

Set the peak parameters

- Click or tap the input field of **Peak Number**, and then use the pop-up numeric keypad to set the number of peaks. Its range is from 1 to 15. Its default value is 5.
- Click or tap the input field of **Threshold**, and then use the pop-up numeric keypad to set the minimum value of the peak amplitude. Only when the peak is greater than the peak threshold, can it be judged as a peak.
- Click or tap the input field of **Excursion**, and then use the pop-up numeric keypad to set the excursion of the peak. It defines the minimum amplitude variation required for a signal to be identified as peak. Its range is from 0.00 dB to 100.00 dB. Its default value is 0 dB.

17 Protocol Decoding

You can use the protocol analysis to discover errors, debug hardware, and accelerate development easily, ensuring you to accomplish the projects with high speed and good quality. Protocol decoding is the basis of protocol analysis. Only protocol analyses with correct protocol decoding are acceptable, and only correct protocol decoding can identify more error information. This oscilloscope provides four bus decoding modules (Decode 1, Decode 2, Decode 3, and Decode 4) to make common protocol decoding (including Parallel (standard), RS232 (option), I2C (option), SPI (option), LIN (option), CAN (option), FlexRay (option), I2S (option), and 1553B (option)) for the input signals of the analog channels (CH1-CH4). As the decoding functions and setting methods of Decode1, Decode2, Decode3, and Decode4, this chapter takes Decode1 as an example for illustration.

- Click or tap the function navigation icon  at the lower-left corner of the screen, and then select **Decode** to enter the "Decode" menu.
- Tap the **Decode** icon on the small screen at the right side of the screen to enter the "Decode" menu.
- Click or tap the **Decode** icon at the top of the screen to enter the "Decode" menu.

To get the decoding option information, refer to descriptions in [Appendix A: Options and Accessories](#).

If you have purchased the decoding option, activate it according the descriptions in [To View the Option Information and the Option Installation](#).

17.1 Parallel Decoding

Parallel bus consists of clock line and data line. As shown in the figure below, CLK is the clock line, whereas Bit0 and Bit1 are the 0 bit and 1st bit on the data line respectively. The oscilloscope will sample the channel data on the rising edge, falling edge, or the rising/falling edge of the clock and judge each data point (logic "1" or logic "0") according to the preset threshold level.

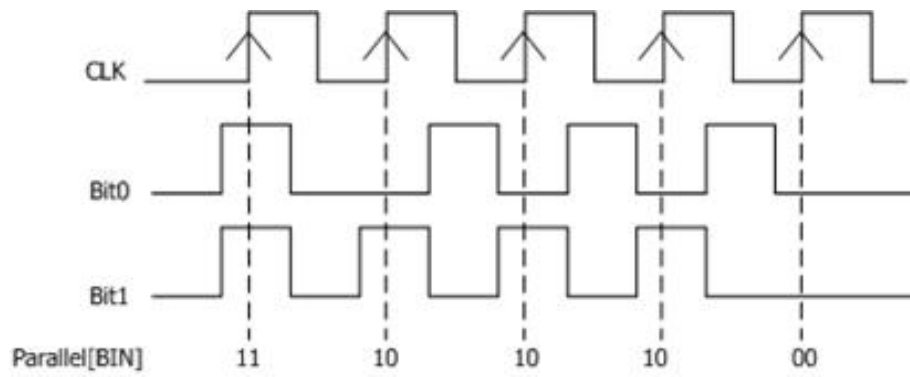

Figure 17.1 Schematic Diagram of Parallel Decoding

In the **Decode** menu, click or tap the drop-down button of **Bus Type** to select **Parallel**, then configure the parameters for Parallel decoding.

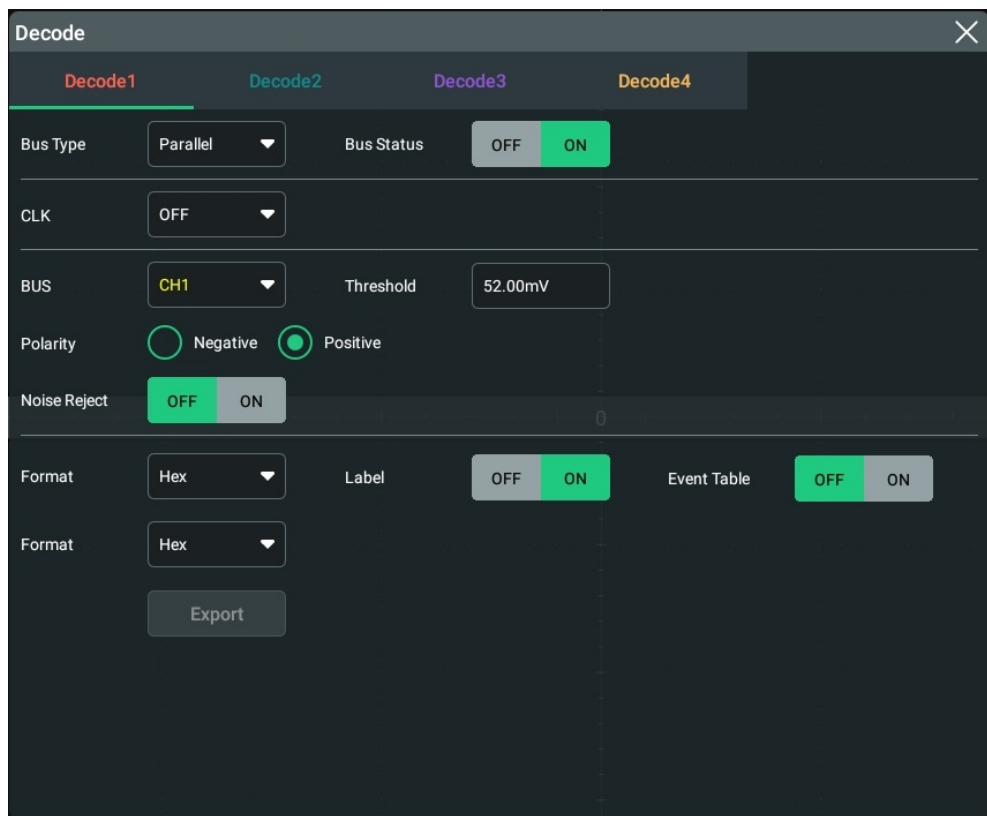

Figure 17.2 Parallel Decoding Menu

Bus Status

Click or tap the ON/OFF button for the **Bus Status** menu item to enable/disable the bus decoding.

17.1.1 Clock Setting (CLK)

Clock Setting (CLK)

Click or tap the drop-down button of **CLK** select the desired source of the clock channel (CH1-CH4) from the drop-down list. If "OFF" is selected, no clock channel is set, and sampling is performed when a hop occurs to the data of the data channel during decoding.

Threshold

When the clock signal is an analog channel (CH1-CH4), you need to set a threshold. Click or tap the input field of **Threshold**, and then use the pop-up numeric keypad to set the threshold. The range of the threshold is related to the current vertical scale and offset.

CLK Edge

In **CLK Edge** menu, click or tap to select to sample the channel data on the rising edge, falling edge, or both edges of the clock signal.

- **Rising:** samples the channel data on the rising edge of the clock.
- **Falling:** samples the channel data on the falling edge of the clock.
- **Both:** samples the channel data on the rising edge or the falling edge of the clock.

17.1.2 Bus Setting

Set the Bus

Click or tap drop-down button of **BUS** to select the digital bus (CH1-CH4) for Parallel decoding from the drop-down list.

Table 17.1 Bus Setting

Bus	Width	Bit X	Channel	Remarks
CH1	1	0	CH1	Width, Bit X, and CH are set automatically, and you cannot modify them.
CH2	1	0	CH2	Width, Bit X, and CH are set automatically, and you cannot modify them.
CH3	1	0	CH3	Width, Bit X, and CH are set automatically, and you cannot modify them.
CH4	1	0	CH4	Width, Bit X, and CH are set automatically, and you cannot modify them.
User	1 to 4, 1 for default	1 (Default)	CH1~CH4	Bit1 to Bit4 are set to CH1 to CH4 respectively.

Set the Threshold Level

To judge logic "1" and logic "0" of the buses, you need to set a threshold for each analog channel (CH1~ CH4). When the channel signal amplitude is greater than the preset threshold, it is judged as logic "1"; otherwise logic "0".

Click or tap the input field of **Threshold**, and then use the pop-up numeric keypad to set the threshold. The range of the threshold is related to the current vertical scale and offset.

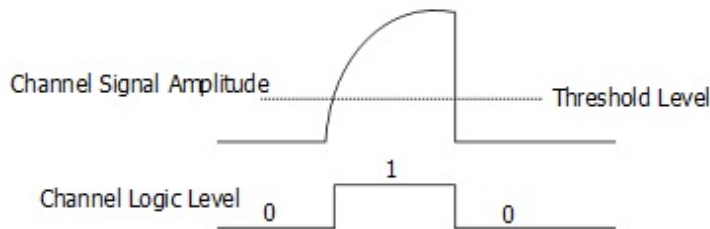

Endian

In **Endian** menu, click or tap to select "Invert" or "Normal" as the endian of the bus.

Polarity

In **Polarity** menu, click or tap to select "Positive" or "Negative" as the data polarity.

17.1.3 Display-related Setting

In **Decode** menu, set the following display-related parameters.

Set the Display Format

Click or tap the drop-down button of **Format** to select the display format of the bus data from the drop-down list. The available options include "Hex", "Dec", "Bin", or "ASCII".

Set the Label Display

Click or tap the ON/OFF tab for the **Label** menu to enable or disable the label display of the decoding bus. When enabled, the bus label will be displayed at the upper-left side of the bus (when the bus display is enabled). The label shows the current bus type.

17.1.4 Event Table

The event table displays the decoded data and the corresponding decoding information in time order in the form of a table. It can be used to observe relatively

longer decoded data. The decoding information includes the decoded data, the corresponding line number, and time information.

Open or Close the Event Table

Click or tap the ON/OFF tab for the **Event Table** menu to enable or disable the display of the event table. When enabled, the following event table is displayed, as shown in the figure below. You can also click or tap the icon  at the upper-right corner of the table to close the event table.

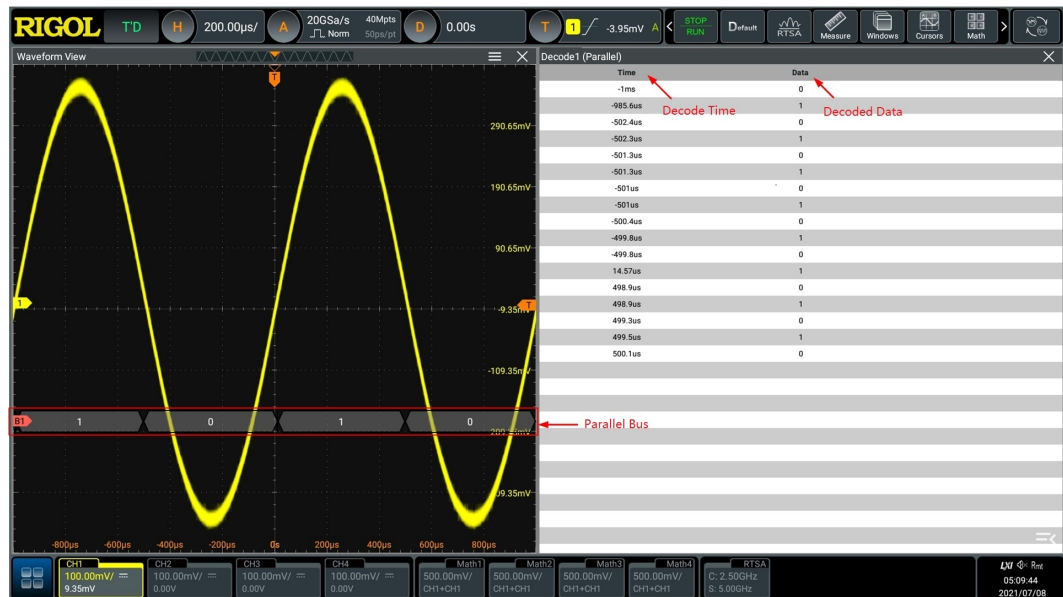

Figure 17.3 Parallel Decoding Event Table



TIP

- When you adjust the horizontal time base, the waveform displayed on the screen will also change, and the total number of lines containing the decoding information in the event table will also be changed.
- The displayed decoded data information in the bus is related to the value of the horizontal time base. Reducing the horizontal time base can help you view the detailed information.

Set the Event Table Format

Click or tap the drop-down button of **Format** to select the display format of "Data" in the event table from the drop-down list. The available options include "Hex", "Dec", "Bin", or "ASCII".

17.2 RS232 Decoding (Option)

RS232 serial bus consists of the transmitting data line (TX) and the receiving data line (RX).

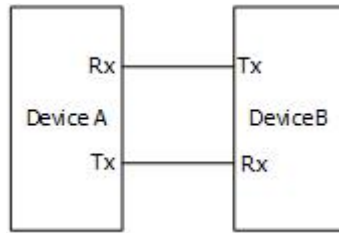

Figure 17.4 Schematic Diagram of RS232 Serial Bus

The industry standard of RS232 uses "Negative Logic", i.g. high level is logic "0" and low level is logic "1".

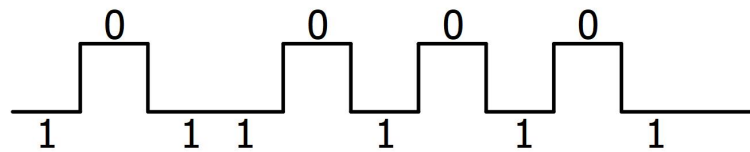

Figure 17.5 Schematic Diagram of Negative Logic

In RS232, baud rate is used to represent the transmission rate (namely bits per second) of the data. You need to set the start bit, data bits, check bit (optional), and stop bits for each frame of data.

Start Bit	Data Bit	Check Bit	Stop Bit
-----------	----------	-----------	----------

- **Start Bit:** indicates when to output data.
- **Data Bit:** indicates the number of data bits actually contained in each frame of data.
- **Check Bit:** used to check whether the data are properly transmitted.
- **Stop Bit:** indicates when to stop outputting data.

In the **Decode** menu, click or tap the drop-down button of **Bus Type** to select **RS232**, then configure the parameters for RS232 decoding.

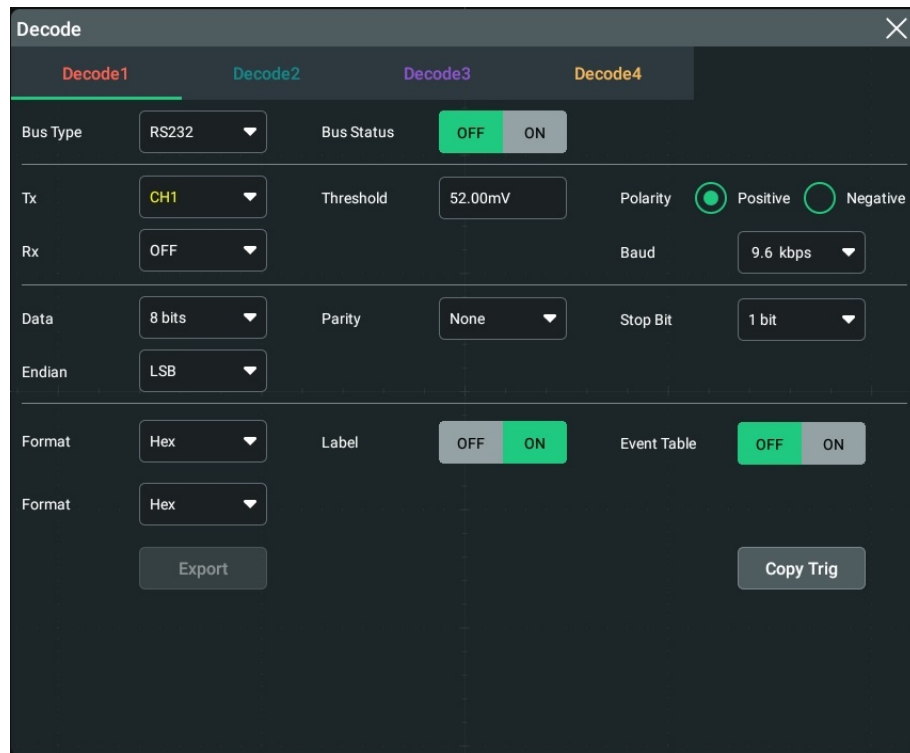

Figure 17.6 RS232 Decoding Menu

Click or tap the ON/OFF button for the **Bus Status** menu item to enable/disable the bus decoding.

Quickly apply trigger settings to decoding

Copy trig indicates applying the trigger settings to the specified decoding setting.

Click or tap **Copy Trig** to apply the trigger settings to the specified decoding setting.

17.2.1 Source Setting

Set the Tx source and the threshold

Click or tap drop-down button of **Tx** to select the desired source from the drop-down list. The sources include CH1-CH4.

Click or tap the input field of **Threshold**, and then use the pop-up numeric keypad to set the threshold of Tx source. The range value is from -5.00 V to 5.00 V. Its default value is 0 V.

When you modify the threshold of the Tx source channel, a dotted line displaying the current threshold level is displayed on the screen. It disappears in about 2 s after you stop modifying the threshold.

Set the Rx source and the threshold

Use the same method to select the **Rx** source and set the threshold. The default state of **Rx** is OFF.

Polarity

Click or tap "Positive" or "Negative" under **Polarity**.

- **Positive:** Uses negative logic. High level is logic "0" and low level is logic "1".
- **Negative:** Uses positive logic. High level is logic "1" and low level is logic "0".

Set the baud rate

Click or tap the drop-down button of **Baud** to select the preset baud rate from the drop-down list. The available baud rates include 50 bps, 75 bps, 110 bps, 134 bps, 150 bps, and etc.

The oscilloscope supports users to self-define the baud rate. Click or tap the drop-down button of **Baud** to select "User" from the drop-down list. Then set the baud rate with the pop-up numeric keypad.

17.2.2 To Set Data Package

Data

Click or tap the drop-down button of **Data** to select the data bits from the drop-down list. The available data bits are 5 bits, 6 bits, 7 bits, 8 bits, and 9 bits.

Parity

It is used to check whether the data transmission is correct. Click or tap the drop-down button of **Parity** to select the desired parity mode.

- **None:** indicates that no check bit appears during the transmission.
- **Even:** indicates that the total number of "1" in the data bit and check bit is an even number. For example, when 0x55 (01010101) is sent, "0" should be added to the check bit.
- **Odd:** indicates that the total number of "1" in the data bit and check bit is an odd number. For example, when 0x55 (01010101) is sent, "1" should be added to the check bit.

Stop Bit

Click or tap the drop-down button of **Stop Bit** to set the stop bits after each frame of data. It can be set to 1 bit, 1.5 bits, or 2 bits.

Endian

Click or tap the drop-down button of **Endian** to select the desired endian.

- **LSB:** indicates Least Significant Bit transmission sequence, i.g. the lowest bit of the data is transmitted first.

- **MSB:** indicates Most Significant Bit transmission sequence, i.g. the highest bit of the data is transmitted first.

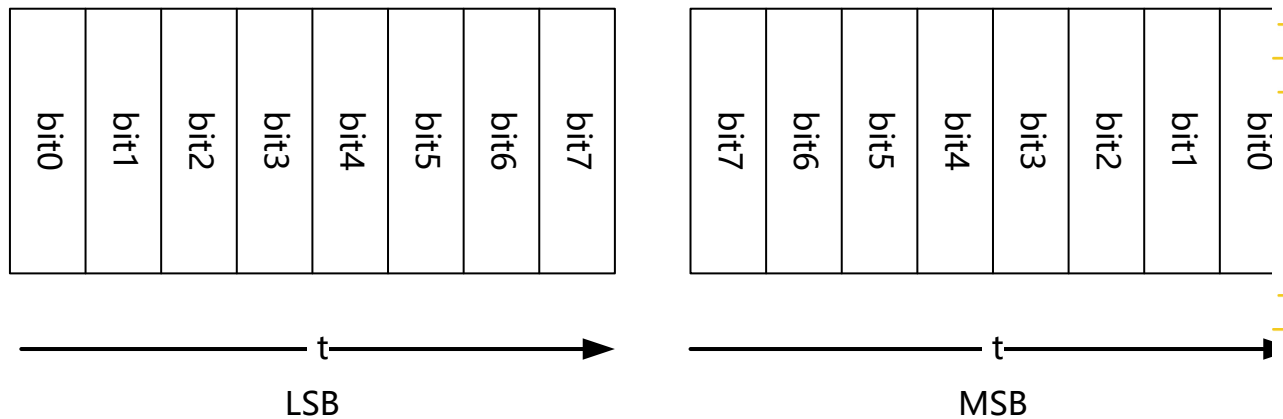

17.2.3 Display-related Setting

In **Decode** menu, set the following display-related parameters.

Set the Display Format

Click or tap the drop-down button of **Format** to select the display format of the bus data from the drop-down list. The available options include "Hex", "Dec", "Bin", or "ASCII".

Set the Label Display

Click or tap the ON/OFF tab for the **Label** menu to enable or disable the label display of the decoding bus. When enabled, the bus label will be displayed at the upper-left side of the bus (when the bus display is enabled). The label shows the current bus type.

17.2.4 Event Table

Click or tap the ON/OFF tab for the **Event Table** menu to enable or disable the display of the event table. When enabled, the following event table is displayed, as shown in the figure below. You can also click or tap the icon  at the upper-right corner of the table to close the event table.

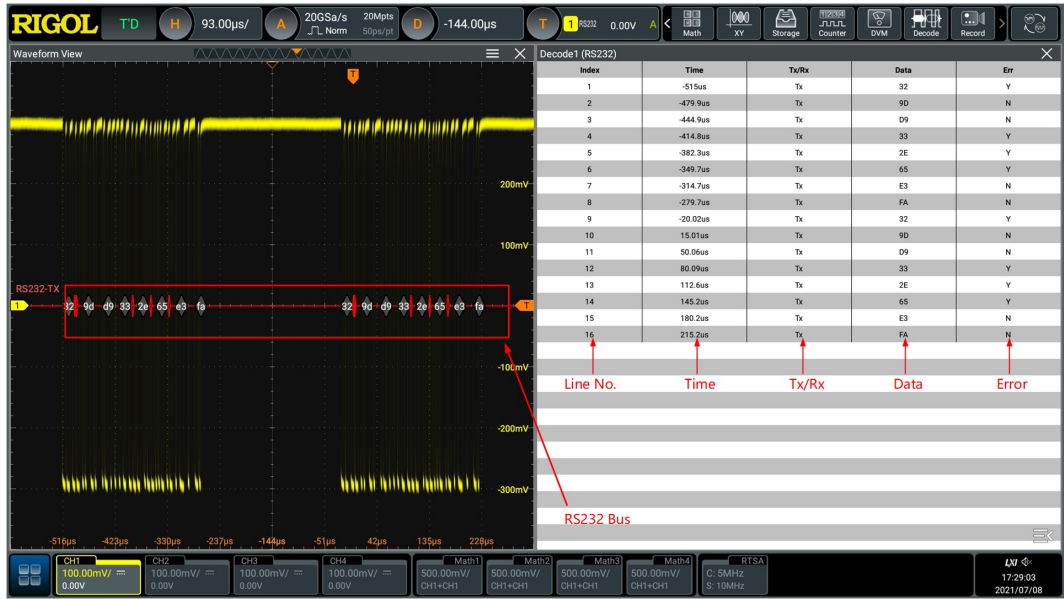

Figure 17.7 RS232 Decoding Event Table



TIP

- When you adjust the horizontal time base, the waveform displayed on the screen will also change, and the total number of lines containing the decoding information in the event table will also be changed.
- The displayed decoded data information in the bus is related to the value of the horizontal time base. Reducing the horizontal time base can help you view the detailed information.

Set the Event Table Format

Click or tap the drop-down button of **Format** to select the display format of "Data" in the event table from the drop-down list. The available options include "Hex", "Dec", "Bin", or "ASCII".

17.3 I2C Decoding (Option)

I2C serial bus consists of the clock line (SCL) and the data line (SDA).

SCL: samples SDA on the of rising or falling edge of the clock.

SDA: indicates the data channel.

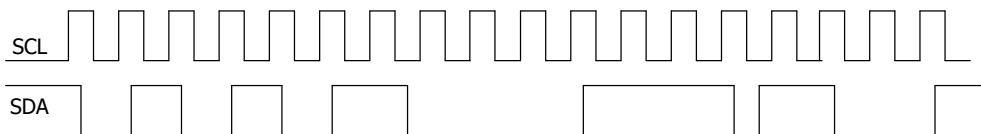

Figure 17.8 I2C Serial Bus

In the **Decode** menu, click or tap the drop-down button of **Bus Type** to select **I2C**, then configure the parameters for I2C decoding.

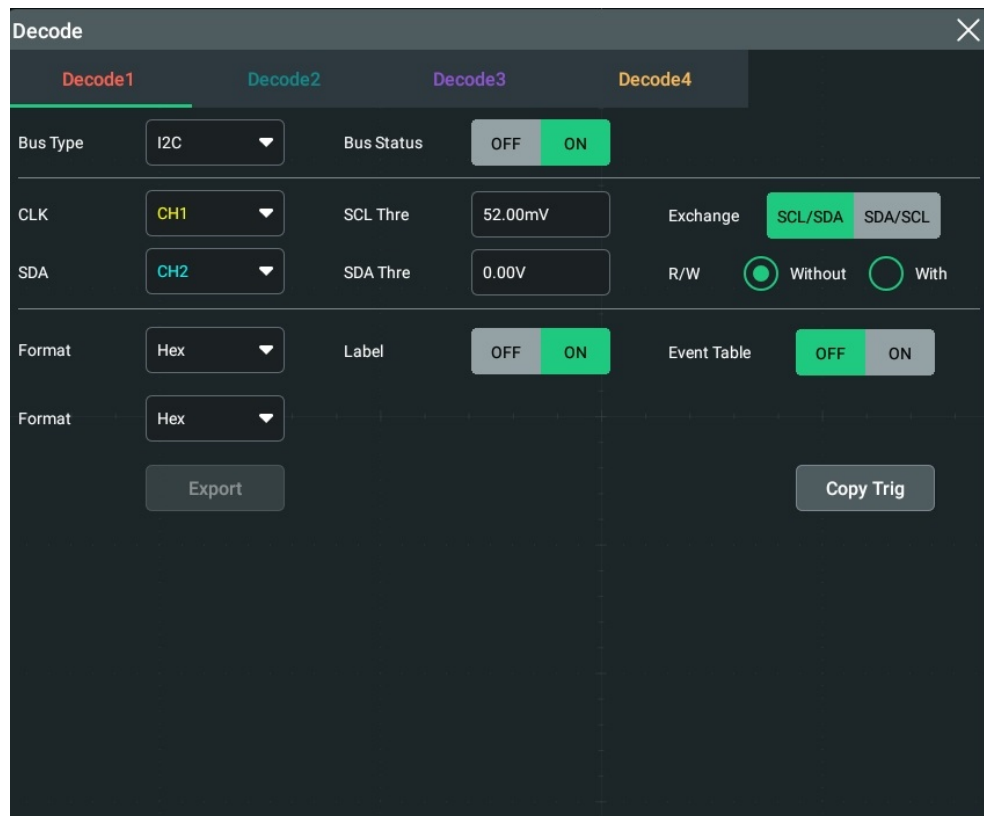

Figure 17.9 I2C Decoding Menu

Bus Status

Click or tap the ON/OFF button for the **Bus Status** menu item to enable/disable the bus decoding.

Quickly apply trigger settings to decoding

Copy trig indicates applying the trigger settings to the specified decoding setting.

Click or tap **Copy Trig** to apply the trigger settings to the specified decoding setting.

17.3.1 Source Setting

Set the clock channel source and the threshold

- Click or tap the drop-down button of **CLK** to select the desired source of the clock channel (CH1-CH4) from the drop-down list.
- Click or tap the input field of **SCL Thre**, and then use the pop-up numeric keypad to set the threshold of the clock channel.

When you modify the threshold of the clock channel, a dotted line displaying the current threshold level is displayed on the screen. It disappears in about 2 s after you stop modifying the threshold.

Set the data channel source and the threshold

- Click or tap the drop-down button of **SDA** to select the desired source of the data channel (CH1-CH4) from the drop-down list.
- Click or tap the input field of **SDA Thre**, and then use the pop-up numeric keypad to set the threshold of the data channel.

Exchange Sources

Click or tap "SCL/SDA" or "SDA/SCL" under **Exchange** to exchange the sources of the current clock channel and data channel.

Specify whether the address information includes the "R/W" bit

For I2C bus, each frame of data starts with the address information. The address information includes the read address and the write address.

Click or tap "Without" or "With" under **R/W** to select whether the address information includes the "R/W" bit. When "**With**" is selected, the "R/W" bit will be included in the address information and located at the lowest bit; when "**Without**" is selected, the "R/W" bit will not be included in the address information.

17.3.2 Display-related Setting

In **Decode** menu, set the following display-related parameters.

Set the Display Format

Click or tap the drop-down button of **Format** to select the display format of the bus data from the drop-down list. The available options include "**Hex**", "**Dec**", "**Bin**", or "**ASCII**".

Set the Label Display

Click or tap the ON/OFF tab for the **Label** menu to enable or disable the label display of the decoding bus. When enabled, the bus label will be displayed at the upper-left side of the bus (when the bus display is enabled). The label shows the current bus type.

17.3.3 Event Table

Open or Close the Event Table

Click or tap the ON/OFF tab for the **Event Table** menu to enable or disable the display of the event table. When enabled, the following event table is displayed, as

shown in the figure below. You can also click or tap the icon  at the upper-right corner of the table to close the event table.

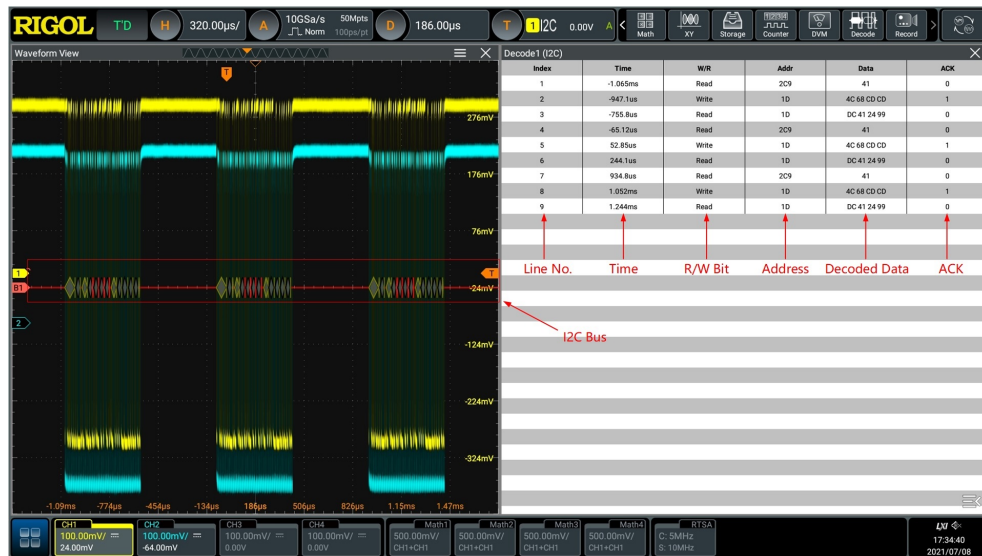

Figure 17.10 I2C Decoding Event Table



TIP

- When you adjust the horizontal time base, the waveform displayed on the screen will also change, and the total number of lines containing the decoding information in the event table will also be changed.
- The displayed decoded data information in the bus is related to the value of the horizontal time base. Reducing the horizontal time base can help you view the detailed information.

Set the Event Table Format

Click or tap the drop-down button of **Format** to select the display format of "Data" in the event table from the drop-down list. The available options include "Hex", "Dec", "Bin", or "ASCII".

Address information in decoding

For I2C bus, each frame of data starts with the address information (read address and write address). In the address information, "Read" indicates the read address

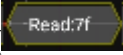
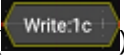
() and "Write" indicates the write address (). You can decide whether to include or exclude the "R/W" bit for the address information.

Error expressions in decoding

In I2C decoding, when ACK (acknowledgment) is 1, ACK error occurs. When the

detected ACK is 1, red error report information  (the display form is related to the value of the horizontal time base) is displayed.

17.4 SPI Decoding (Option)

SPI bus is based on the master— slave configuration and usually consists of chip select line (CS), clock line (CLK), and data line (SDA). Wherein, the data lines include the master input/slave output (MISO) data line and master output/slave input (MOSI) data line. The oscilloscope samples the channel data on the rising or falling edge of the clock signal (if the source is an analog channel, the oscilloscope will also judge each data point (logic "1" or logic "0") according to the preset threshold level).

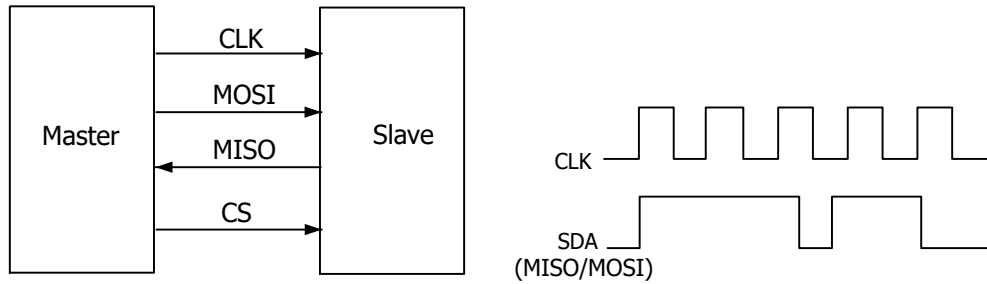

Figure 17.11 SPI Serial Bus

In the **Decode** menu, click or tap the drop-down button of **Bus Type** to select **SPI**, then configure the parameters for SPI decoding.

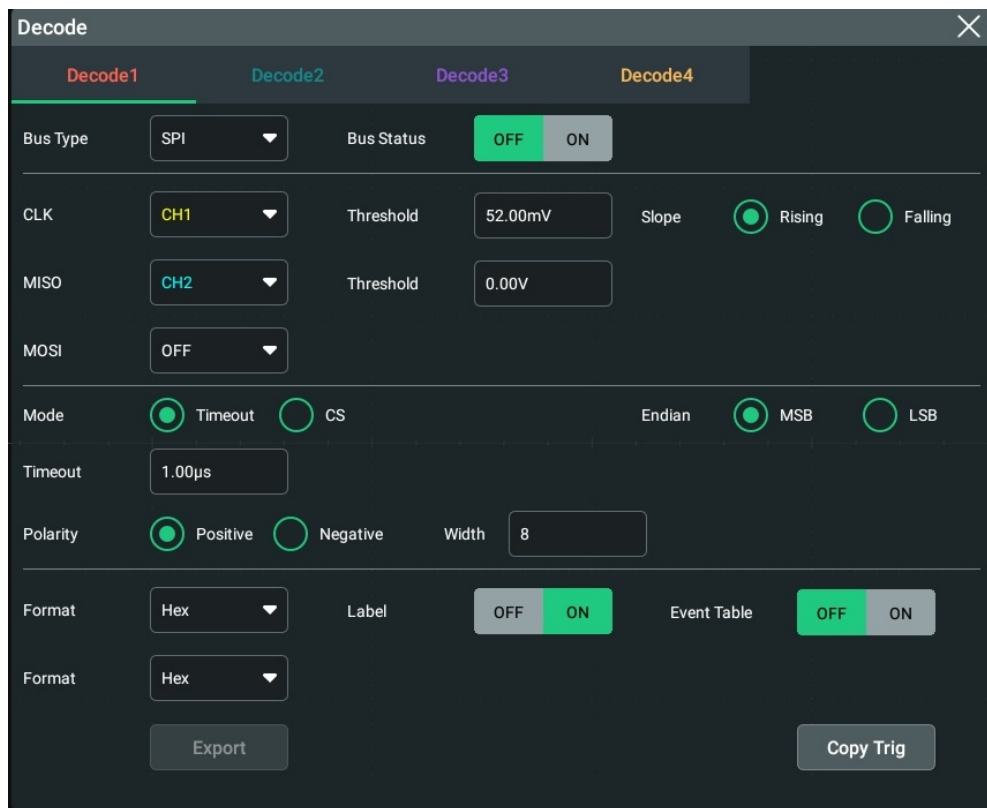

Figure 17.12 SPI Decoding Menu

Bus Status

Click or tap the ON/OFF button for the **Bus Status** menu item to enable/disable the bus decoding.

Quickly apply trigger settings to decoding

Copy trig indicates applying the trigger settings to the specified decoding setting.

Click or tap **Copy Trig** to apply the trigger settings to the specified decoding setting.

17.4.1 To Set the Source

Set the Clock Signal

- Click or tap the drop-down button of **CLK** to select the desired source of the clock channel from the drop-down list. The sources include CH1-CH4.
- Click or tap the input field of **Threshold** at the right side of the **CLK** menu, and then use the pop-up numeric keypad to set the threshold of the clock channel.
- Click or tap "Rising" or "Falling" under **Slope** to set the instrument to sample MISO and MOSI on the CLK.

MISO and MOSI Setting

- Click or tap drop-down button of **MISO** to select the desired source of MISO from the drop-down list. The sources include CH1-CH4 and OFF.
- Click or tap the input field of **Threshold** at the right side of **MISO**, and then use the pop-up numeric keypad to set the threshold of the MISO channel.
- Click or tap drop-down button of **MOSI** to select the desired source of MOSI from the drop-down list. The sources include CH1-CH4 and OFF.



TIP

The source channels of MISO and MOSI cannot be set to "OFF" at the same time.

17.4.2 To Set Mode and Data

Mode

Click or tap "Timeout" or "CS" under **Mode**.

- **Timeout:**

you can perform frame synchronization according to the timeout, and the timeout value must be greater than half of the clock cycle. Click or tap the input field of **Timeout**, and then use the pop-up numeric keypad to set the timeout value. The adjustable range of the timeout value is from 8 ns to 10 s. By default, it is 1 μ s.

- **CS:**

contains a chip select line (CS). You can perform frame synchronization according to CS. When "CS" is selected,

- Click or tap drop-down button of **CS** to select the desired source from the drop-down list. The sources include CH1-CH4.
- Click or tap the input field for the **Threshold** menu item to set the threshold with the pop-up numeric keypad.
- In **CS Polarity** menu, click or tap to select "**Positive**" or "**Negative**".

Endian

Click or tap the drop-down button of **Endian** to select the desired endian.

- **LSB:** indicates Least Significant Bit transmission sequence, i.g. the lowest bit of the data is transmitted first.
- **MSB:** indicates Most Significant Bit transmission sequence, i.g. the highest bit of the data is transmitted first.

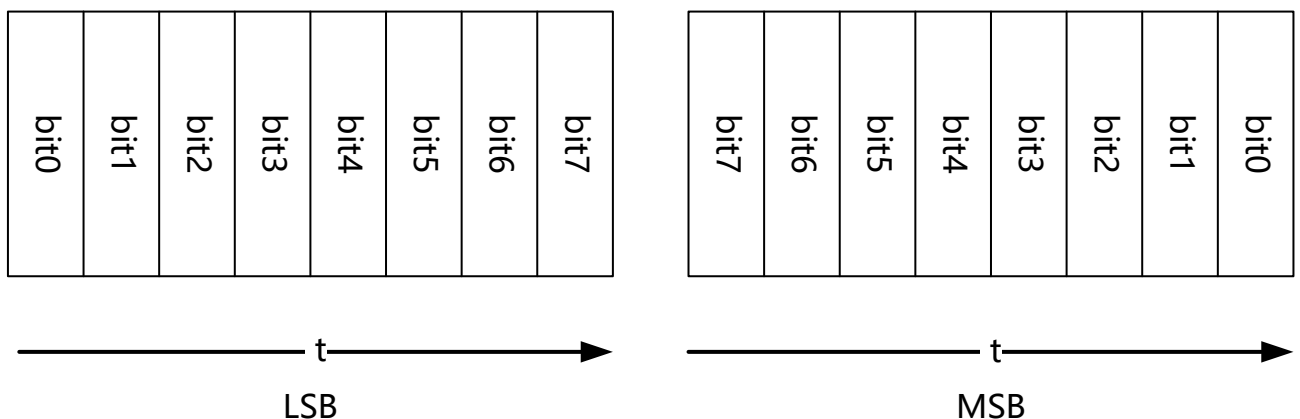

Polarity

In **Polarity** menu, click or tap to select "**Positive**" or "**Negative**".

Width Setting

Click or tap the input field of **Width**, and then use the pop-up numeric keypad to set the bits of each frame of data. The setting range is from 4 to 32. By default, it is 8.

17.4.3 Display-related Setting

In **Decode** menu, set the following display-related parameters.

Set the Display Format

Click or tap the drop-down button of **Format** to select the display format of the bus data from the drop-down list. The available options include "Hex", "Dec", "Bin", or "ASCII".

Set the Label Display

Click or tap the ON/OFF tab for the **Label** menu to enable or disable the label display of the decoding bus. When enabled, the bus label will be displayed at the upper-left side of the bus (when the bus display is enabled). The label shows the current bus type.

17.4.4 Event Table

Open or Close the Event Table

Click or tap the ON/OFF tab for the **Event Table** menu to enable or disable the display of the event table. When enabled, the following event table is displayed, as shown in the figure below. You can also click or tap the icon  at the upper-right corner of the table to close the event table.

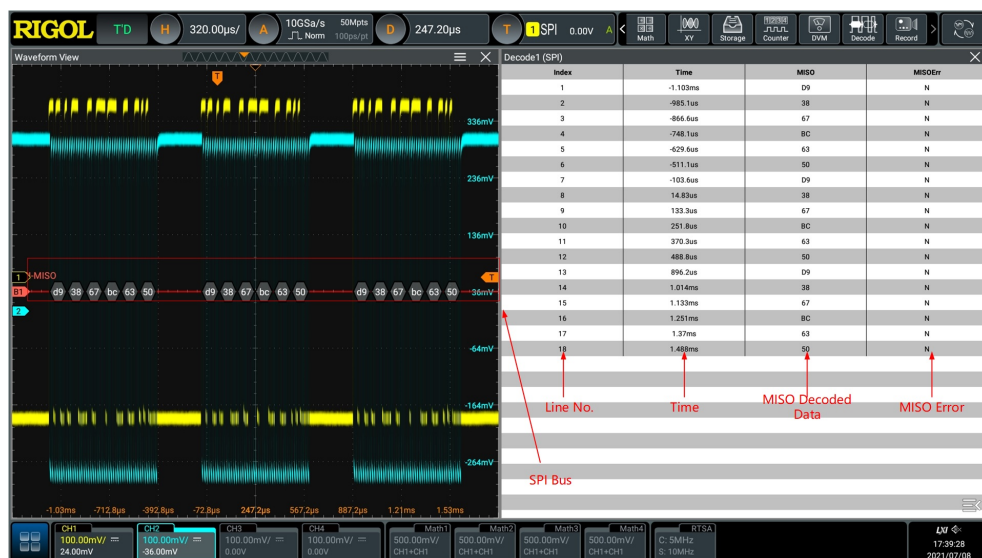

Figure 17.13 SPI Decoding Event Table



TIP

- When you adjust the horizontal time base, the waveform displayed on the screen will also change, and the total number of lines containing the decoding information in the event table will also be changed.
- The displayed decoded data information in the bus is related to the value of the horizontal time base. Reducing the horizontal time base can help you view the detailed information.

Set the Event Table Format

Click or tap the drop-down button of **Format** to select the display format of "Data" in the event table from the drop-down list. The available options include "Hex", "Dec", "Bin", or "ASCII".

17.5 LIN Decoding (Option)

The oscilloscope samples the LIN signal, and judges each data point to be logic "1" or logic "0" according to the preset threshold level. The LIN decoding is required to specify the LIN signal protocol version.

In the **Decode** menu, click or tap the drop-down button of **Bus Type** to select **LIN**, then configure the parameters for LIN decoding.

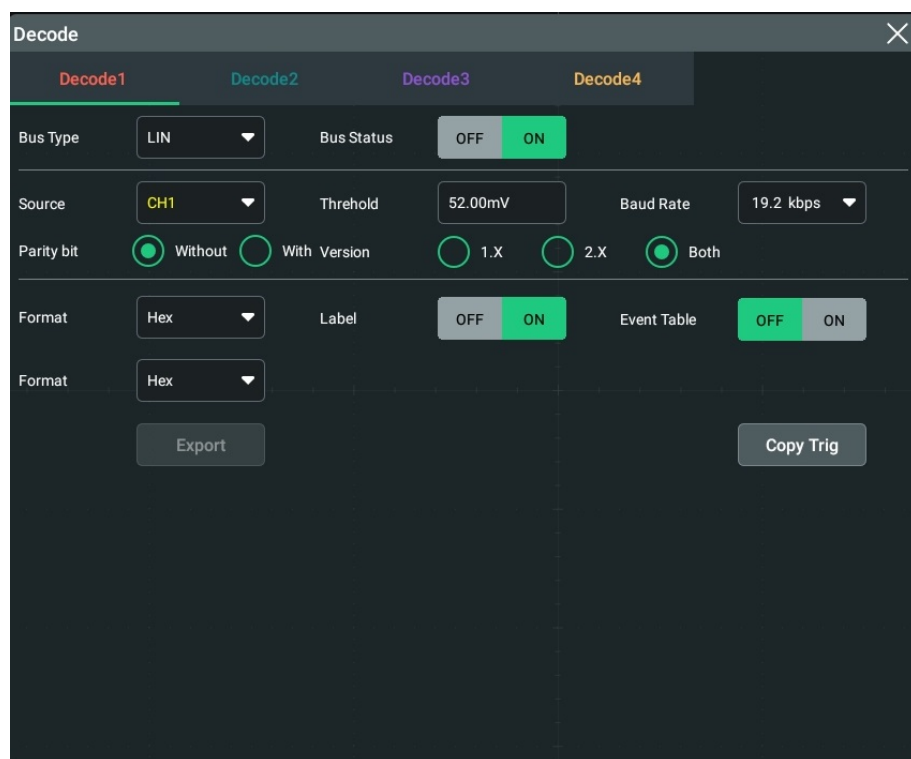

Figure 17.14 LIN Decoding Menu

Bus Status

Click or tap the ON/OFF button for the **Bus Status** menu item to enable/disable the bus decoding.

Quickly apply trigger settings to decoding

Copy trig indicates applying the trigger settings to the specified decoding setting.

Click or tap **Copy Trig** to apply the trigger settings to the specified decoding setting.

17.5.1 Signal Configuration

Set the source and the threshold

- Click or tap drop-down button of **Source** to select the desired source from the drop-down list. The sources include CH1-CH4.
- Click or tap the input field of **Threshold**, and then use the pop-up numeric keypad to set the threshold of the source channel.

When you modify the threshold of the clock channel, a dotted line displaying the current threshold level is displayed on the screen. It disappears in about 2 s after you stop modifying the threshold.

Set the signal

- Click or tap the drop-down button of **Baud Rate** from the drop-down list. The available baud rates include 2.4 kbps, 4.8 kbps, 9.6 kbps, 10.0 kbps, 19.2 kbps, and etc.
- In **Parity bit** menu, click or tap **"With"** or **"Without"** to select whether the data contain the parity bit.
- In **Version** menu, select the protocol version that matches the LIN bus signal. The available versions include **"1.X"**, **"2.X"**, and **"Both"**.

17.5.2 Display-related Setting

In **Decode** menu, set the following display-related parameters.

Set the Display Format

Click or tap the drop-down button of **Format** to select the display format of the bus data from the drop-down list. The available options include **"Hex"**, **"Dec"**, **"Bin"**, or **"ASCII"**.

Set the Label Display

Click or tap the ON/OFF tab for the **Label** menu to enable or disable the label display of the decoding bus. When enabled, the bus label will be displayed at the upper-left side of the bus (when the bus display is enabled). The label shows the current bus type.

17.5.3 Event Table

Open or Close the Event Table

Click or tap the ON/OFF tab for the **Event Table** menu to enable or disable the display of the event table. When enabled, the following event table is displayed, as shown in the figure below. You can also click or tap the icon  at the upper-right corner of the table to close the event table.



Figure 17.15 LIN Decoding Event Table



TIP

- When you adjust the horizontal time base, the waveform displayed on the screen will also change, and the total number of lines containing the decoding information in the event table will also be changed.
- The displayed decoded data information in the bus is related to the value of the horizontal time base. Reducing the horizontal time base can help you view the detailed information.

Set the Event Table Format

Click or tap the drop-down button of **Format** to select the display format of "Data" in the event table from the drop-down list. The available options include "**Hex**", "**Dec**", "**Bin**", or "**ASCII**".

Interpret the Decoded LIN Data

- Break (Sync Break): expressed in Hex, identified as "Break:".
- SYNC (Sync): expressed in Hex, identified as "SYNC:".
- ID (Frame ID): expressed in Hex, identified as "ID:".
- Data (Data): Its display format is the same as that of the bus data (Hex, Dec, Bin, or ASCII), identified as "Data:".
- CRC (Cyclic Redundancy Check): expressed in Hex, identified as "CRC:". When errors occur, it is displayed as a red patch for the checksum error.
- Wakeup (wake up symbol): identified as "Wakeup:".

17.6 CAN Decoding (Option)

The oscilloscope samples the CAN or CAN-FD signal at the specified sample position, and judges each data point to be logic "1" or logic "0" according to the preset threshold level. You need to specify the CAN or CAN-FD signal type and sample position for CAN decoding.

In the **Decode** menu, click or tap the drop-down button of **Bus Type** to select **CAN**, then configure the parameters for CAN decoding.

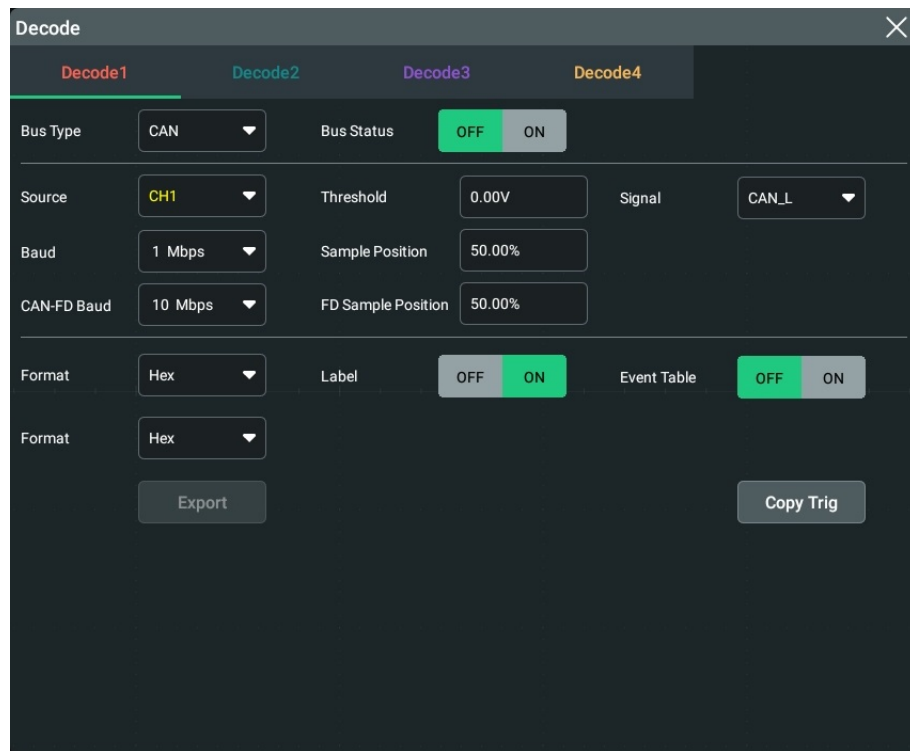

Figure 17.16 CAN Decoding Menu

Bus Status

Click or tap the ON/OFF button for the **Bus Status** menu item to enable/disable the bus decoding.

Quickly apply trigger settings to decoding

Copy trig indicates applying the trigger settings to the specified decoding setting.

Click or tap **Copy Trig** to apply the trigger settings to the specified decoding setting.

17.6.1 Signal Configuration

Set the source and the threshold

- Click or tap drop-down button of **Source** to select the desired source from the drop-down list. The sources include CH1-CH4.

- Click or tap the input field of **Threshold**, and then use the pop-up numeric keypad to set the threshold of the source channel.

When you modify the threshold of the clock channel, a dotted line displaying the current threshold level is displayed on the screen. It disappears in about 2 s after you stop modifying the threshold.

Select the Signal Type

Click or tap the drop-down button of **Signal** to select a signal type that matches the CAN bus signal. The available signal types include CAN_H, CAN_L, Rx, Tx, and Diff.

- CAN_H**: indicates the actual CAN_H bus signal.
- CAN_L**: indicates the actual CAN_L bus signal.
- Rx**: indicates the Receive signal from the CAN bus transceiver.
- Tx**: indicates the Transmit signal from the CAN bus transceiver.
- DIFF**: The CAN differential bus signals connected to an analog source channel by using a differential probe. Connect the probe's positive lead to the CAN_H bus signal and connect the negative lead to the CAN_L bus signal.

Specify the Standard Signal Rate

Click or tap the drop-down button of **Baud** to select the preset baud rate from the drop-down list. The available baud rates include 10.0 kbps, 19.2 kbps, 20.0 kbps, 33.3 kbps, 38.4 kbps, 50.0 kbps, and etc.

Sample Position

Sample position is a point within a bit's time. The oscilloscope samples the bit level at this point. The sample position is represented by the proportion of "the time from the start of the bit to the sample point" to the "bit time", as shown in the figure below.

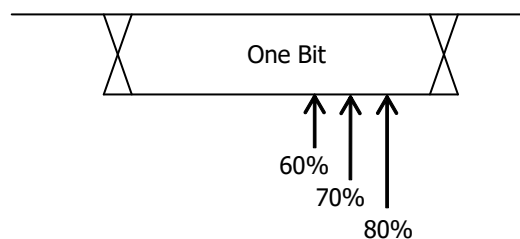

Figure 17.17 Sample Position

Click or tap the input field of **Sample Position** to set it by using the pop-up numeric keypad. The settable range is from 10% to 90%.

Set the CAN-FD Baud

CAN-FD baud is a dedicated parameter configured for the CAN-FD decoding. Click or tap the drop-down button of **CAN-FD Baud** to select the variable baud rate from the drop-down list. The available baud rates include 1 Mbps, 2 Mbps, 3 Mbps, 4 Mbps, and etc.

Set the FD Sample Position

FD sample position is a dedicated parameter configured for the CAN-FD decoding. Click or tap the input field of **FD Sample Position** to set it by using the pop-up numeric keypad. The settable range is from 10% to 90%.

17.6.2 Display-related Setting

In **Decode** menu, set the following display-related parameters.

Set the Display Format

Click or tap the drop-down button of **Format** to select the display format of the bus data from the drop-down list. The available options include "Hex", "Dec", "Bin", or "ASCII".

Set the Label Display

Click or tap the ON/OFF tab for the **Label** menu to enable or disable the label display of the decoding bus. When enabled, the bus label will be displayed at the upper-left side of the bus (when the bus display is enabled). The label shows the current bus type.

17.6.3 Event Table

Open or Close the Event Table

Click or tap the ON/OFF tab for the **Event Table** menu to enable or disable the display of the event table. When enabled, the following event table is displayed, as

shown in the figure below. You can also click or tap the icon  at the upper-right corner of the table to close the event table.

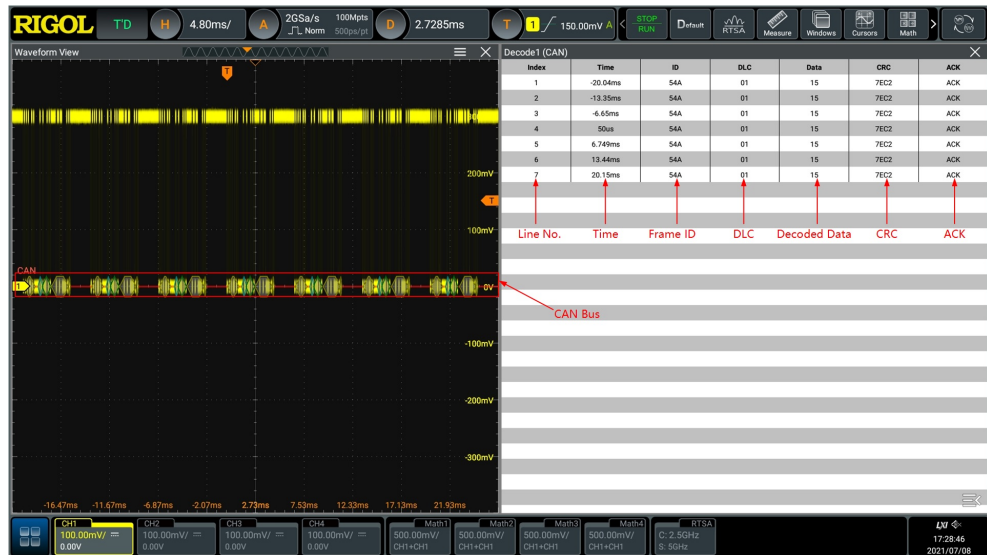

Figure 17.18 CAN Decoding Event Table



TIP

- When you adjust the horizontal time base, the waveform displayed on the screen will also change, and the total number of lines containing the decoding information in the event table will also be changed.
- The displayed decoded data information in the bus is related to the value of the horizontal time base. Reducing the horizontal time base can help you view the detailed information.

Set the Event Table Format

Click or tap the drop-down button of **Format** to select the display format of "Data" in the event table from the drop-down list. The available options include "Hex", "Dec", "Bin", or "ASCII".

Interpret the Decoded CAN Data

- Frame ID: expressed in Hex, identified as "ID:".
- DLC (Data Length Code): expressed in Hex, identified as "DLC:".
- Data: Its display format is the same as that of the bus data (Hex, Dec, Bin, or ASCII), identified as "Data:".
- CRC (Cyclic Redundancy Check): expressed in Hex, identified as "CRC:".
- ACK (Acknowledgement): identified as "ACK". When errors (ACK is detected to be 1) occur, displayed as a red patch.
- R (remote frame): identified as "R:".

- Stuff (Bit filling error): identified as "Stuff".

17.7 FlexRay Decoding (Option)

FlexRay is a type of differential serial bus configured with three consecutive segments (i.g. packet header, payload, and packet trailer). The oscilloscope samples the FlexRay signal at the specified sample position and judges each data point as logic "1" or logic "0" according to the preset threshold level. The FlexRay decoding is required to specify the signal type and baud rate.

In the **Decode** menu, click or tap the drop-down button of **Bus Type** to select **FlexRay**, then configure the parameters for FlexRay decoding.

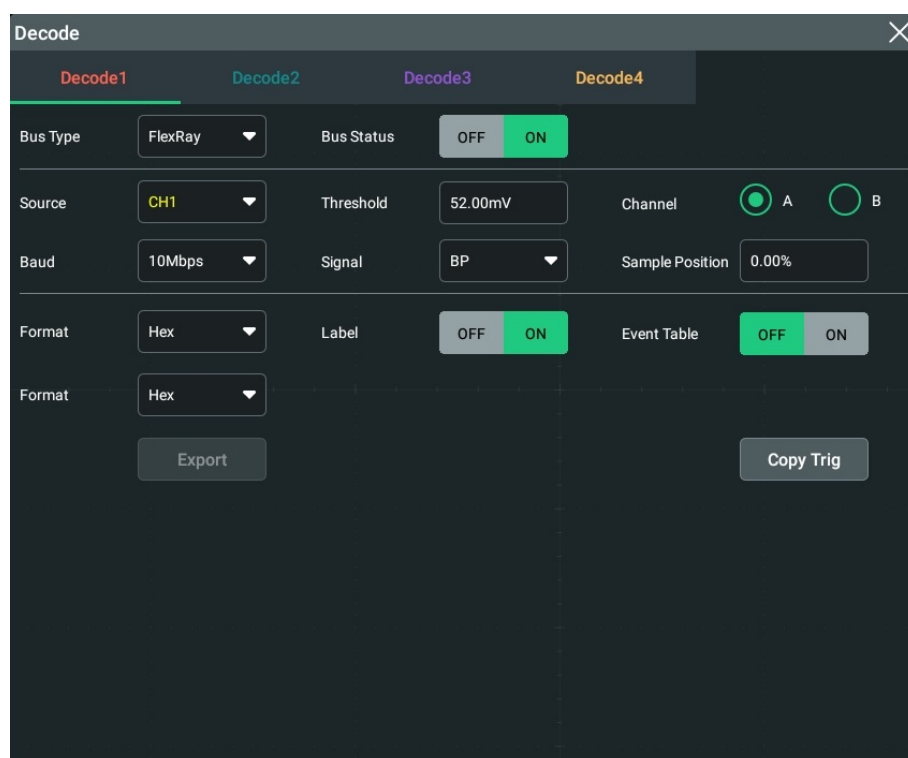

Figure 17.19 FlexRay Decoding Menu

Bus Status

Click or tap the ON/OFF button for the **Bus Status** menu item to enable/disable the bus decoding.

Quickly apply trigger settings to decoding

Copy trig indicates applying the trigger settings to the specified decoding setting.

Click or tap **Copy Trig** to apply the trigger settings to the specified decoding setting.

17.7.1 Signal Configuration

Set the source and the threshold

- Click or tap drop-down button of **Source** to select the desired source from the drop-down list. The sources include CH1-CH4.
- Click or tap the input field of **Threshold**, and then use the pop-up numeric keypad to set the threshold of the source channel.

When you modify the threshold of the clock channel, a dotted line displaying the current threshold level is displayed on the screen. It disappears in about 2 s after you stop modifying the threshold.

To Select the Signal

Click or tap "A" or "B" under **Channel** to select a channel that matches the actual FlexRay bus signal.

Specify the Signal Rate

Click or tap the drop-down button **Baud** to select a FlexRay baud rate that matches the FlexRay bus signal. The available baud rate includes "2.5 Mbps", "5 Mbps", and "10 Mbps".

Set the Signal Type

Click or tap the drop-down button **Signal** to select a signal type that matches the actual FlexRay bus signal. The available signal types include "BP", "BM", and "RX/TX".

Sample Position

Sample position is a point within a bit's time. The oscilloscope samples the bit level at this point. The sample position is represented by the proportion of "the time from the start of the bit to the sample point" to the "bit time", as shown in the figure below.

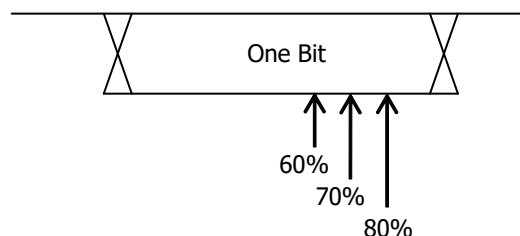

Figure 17.20 Sample Position

Click or tap the input field of **Sample Position** to set it by using the pop-up numeric keypad. The settable range is from 10% to 90%.

17.7.2 Display-related Setting

In **Decode** menu, set the following display-related parameters.

Set the Display Format

Click or tap the drop-down button of **Format** to select the display format of the bus data from the drop-down list. The available options include "Hex", "Dec", "Bin", or "ASCII".

Set the Label Display

Click or tap the ON/OFF tab for the **Label** menu to enable or disable the label display of the decoding bus. When enabled, the bus label will be displayed at the upper-left side of the bus (when the bus display is enabled). The label shows the current bus type.

17.7.3 Event Table

Open or Close the Event Table

Click or tap the ON/OFF tab for the **Event Table** menu to enable or disable the display of the event table. When enabled, the following event table is displayed, as shown in the figure below. You can also click or tap the icon  at the upper-right corner of the table to close the event table.



Figure 17.21 FlexRay Decoding Event Table



TIP

- When you adjust the horizontal time base, the waveform displayed on the screen will also change, and the total number of lines containing the decoding information in the event table will also be changed.

- The displayed decoded data information in the bus is related to the value of the horizontal time base. Reducing the horizontal time base can help you view the detailed information.

Set the Event Table Format

Click or tap the drop-down button of **Format** to select the display format of "Data" in the event table from the drop-down list. The available options include "Hex", "Dec", "Bin", or "ASCII".

Interpret the decoded FlexRay frame data

- TSS: transmission start sequence, identified as "TSS:".
- Sync Frame: identified as "SYNC:".
- ID (Frame ID): expressed in Hex, identified as "ID:".
- PL (Payload Length): expressed in Hex, identified as "PL:".
- HCRC (Header Cyclic Redundancy Check): expressed in Hex, identified as "HCRC:". When error occurs, it is displayed as a red patch.
- CYC (Cycle Number): expressed in Hex, identified as "CYC:".
- Data: Its display format is the same as that of the bus data (Hex, Dec, Bin, or ASCII), identified as "Data:".
- TCRC (Header Cyclic Redundancy Check): expressed in Hex, identified as "TCRC:". When error occurs, it is displayed as a red patch.

17.8 I2S Decoding (Option)

The oscilloscope samples the I2S signal, and judges each data point to be logic "1" or logic "0" according to the preset threshold level. I2S decoding is required to specify the serial clock, channel signal, and the data's source channel. You need to set Alignment, WS Low, and other parameters.

In the **Decode** menu, click or tap the drop-down button of **Bus Type** to select **I2S**, then configure the parameters for I2S decoding.

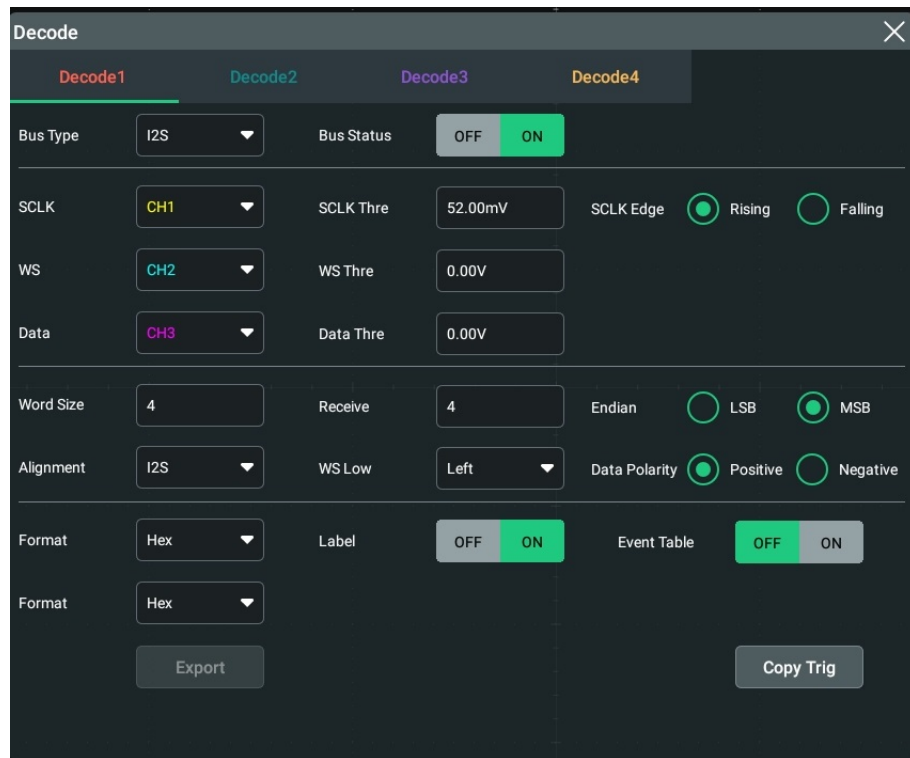

Figure 17.22 I2S Decoding Menu

Bus Status

Click or tap the ON/OFF button for the **Bus Status** menu item to enable/disable the bus decoding.

Quickly apply trigger settings to decoding

Copy trig indicates applying the trigger settings to the specified decoding setting.

Click or tap **Copy Trig** to apply the trigger settings to the specified decoding setting.

17.8.1 Source Setting

Set the SCLK source and threshold

- Click or tap the drop-down button of **SCLK** to select the desired channel (CH1-CH4) from the drop-down list as the serial clock source.
- Click or tap the input field of **SCLK Thre**, and then use the pop-up numeric keypad to set the threshold of the SCLK. When you modify the threshold of the clock channel, a dotted line displaying the current threshold level is displayed on the screen. It disappears in about 2 s after you stop modifying the threshold.
- In **SCLK Edge** menu, click or tap to select "Rising" or "Falling" as the desired clock edge.

Set the WS source and threshold

- Click or tap the drop-down button of **WS** to select the desired channel (CH1-CH4) from the drop-down list as the WS source.
- Click or tap the input field of **WS Thre**, and then use the pop-up numeric keypad to set the threshold of the WS signal. When you modify the WS threshold, a dotted line displaying the current threshold level is displayed on the screen. It disappears in about 2 s after you stop modifying the threshold.

Set the SDA source and threshold

- Click or tap the drop-down button of **SDA** to select the desired SDA source (CH1-CH4) from the drop-down list.
- Click or tap the input field of **Data Thre**, and then use the pop-up numeric keypad to set the threshold of the data signal. When you modify the data threshold, a dotted line displaying the current threshold level is displayed on the screen. It disappears in about 2 s after you stop modifying the threshold.

17.8.2 Bus Setting

Set the word size

Click or tap the input field of **Word Size**, and then use the pop-up numeric keypad to set the word size. Its range is from 4 to 32.

Set the receiver word size

Click or tap the input field of **Receive**, and then use the pop-up numeric keypad to set the receiver word size. Its range is from 4 to 32.

Set the endian

In **Endian** menu, click or tap to select "**LSB**" or "**MSB**". By default, it is "MSB".

Set the alignment mode

Click or tap the drop-down button of **Alignment** to select the alignment way for data signal. The available choices include "**I2S**", "**LJ**", and "**RJ**".

Set the audio polarity

Click or tap the drop-down button of **WS Low** to select "**Left**" or "**Right**".

Set the data polarity

In **Data Polarity** menu, click or tap to select "**Positive**" or "**Negative**".

17.8.3 Display-related Setting

In **Decode** menu, set the following display-related parameters.

Set the Display Format

Click or tap the drop-down button of **Format** to select the display format of the bus data from the drop-down list. The available options include "Hex", "Dec", "Bin", or "ASCII".

Set the Label Display

Click or tap the ON/OFF tab for the **Label** menu to enable or disable the label display of the decoding bus. When enabled, the bus label will be displayed at the upper-left side of the bus (when the bus display is enabled). The label shows the current bus type.

17.8.4 Event Table

Open or Close the Event Table

Click or tap the ON/OFF tab for the **Event Table** menu to enable or disable the display of the event table. When enabled, the following event table is displayed, as shown in the figure below. You can also click or tap the icon  at the upper-right corner of the table to close the event table.

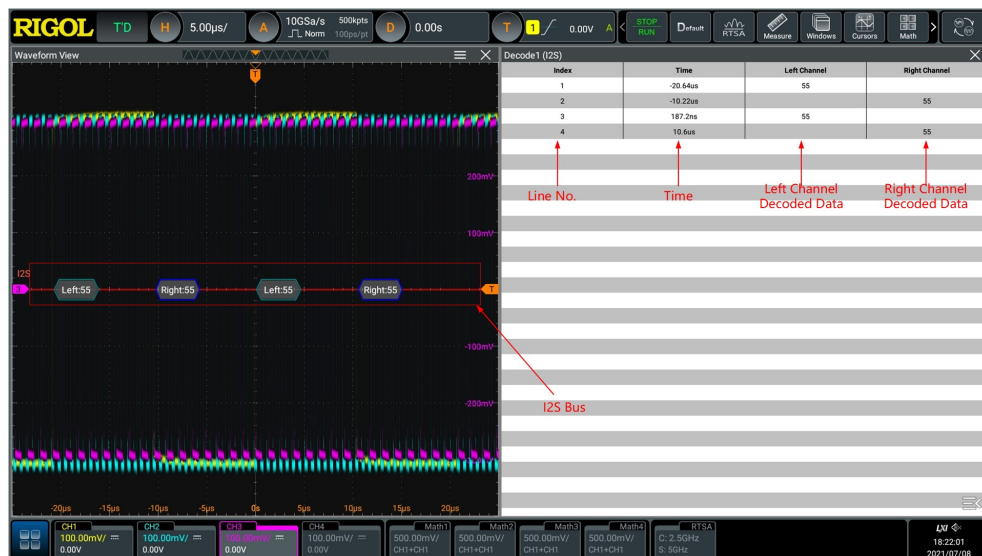

Figure 17.23 I2S Decoding Event Table



TIP

- When you adjust the horizontal time base, the waveform displayed on the screen will also change, and the total number of lines containing the decoding information in the event table will also be changed.
- The displayed decoded data information in the bus is related to the value of the horizontal time base. Reducing the horizontal time base can help you view the detailed information.

Set the Event Table Format

Click or tap the drop-down button of **Format** to select the display format of "Data" in the event table from the drop-down list. The available options include "Hex", "Dec", "Bin", or "ASCII".

17.9 1553B Decoding (Option)

The oscilloscope samples the 1553B signal, and judges each data point to be logic "1" or logic "0" according to the preset threshold level. 1553B decoding is required to specify the data channel source and the threshold.

In the **Decode** menu, click or tap the drop-down button of **Bus Type** to select **1553B**, then configure the parameters for 1553B decoding.

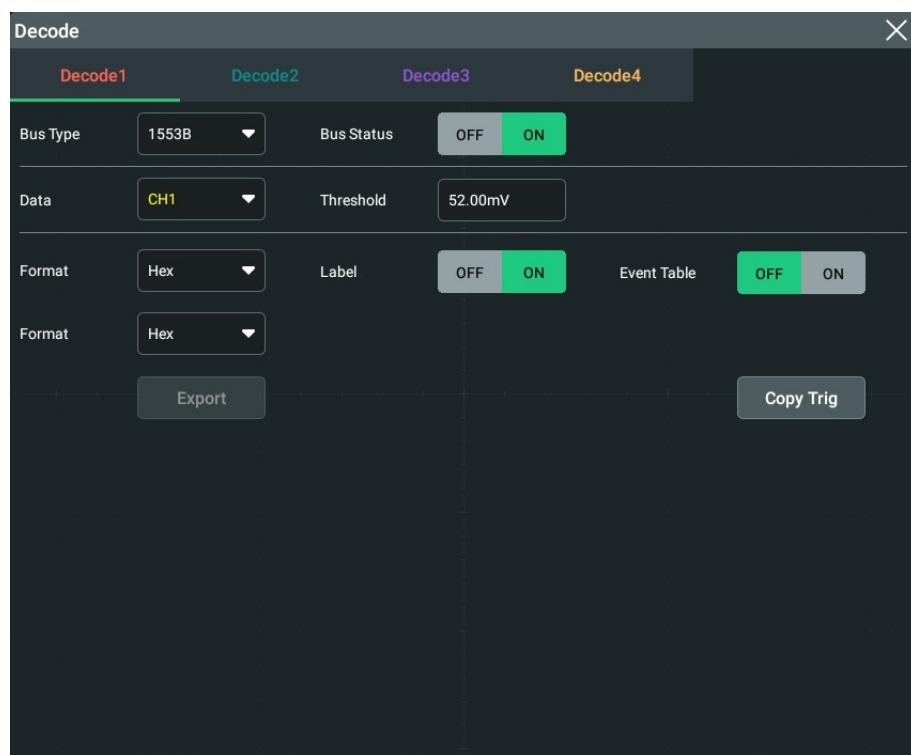

Figure 17.24 1553B Decoding Menu

Bus Status

Click or tap the ON/OFF button for the **Bus Status** menu item to enable/disable the bus decoding.

Quickly apply trigger settings to decoding

Copy trig indicates applying the trigger settings to the specified decoding setting.

Click or tap **Copy Trig** to apply the trigger settings to the specified decoding setting.

17.9.1 To Set the Data Channel Source and the Threshold

Select the Data Channel

Click or tap the drop-down button of **Data** to select the desired data channel source (CH1-CH4) from the drop-down list.

Set the Threshold

Click or tap the input field of **Threshold**, and then use the pop-up numeric keypad to set the threshold of the source channel.

When you modify the threshold of the channel, a dotted line displaying the current threshold level is displayed on the screen. It disappears in about 2 s after you stop modifying the threshold.

17.9.2 Display-related Setting

In **Decode** menu, set the following display-related parameters.

Set the Display Format

Click or tap the drop-down button of **Format** to select the display format of the bus data from the drop-down list. The available options include "Hex", "Dec", "Bin", or "ASCII".

Set the Label Display

Click or tap the ON/OFF tab for the **Label** menu to enable or disable the label display of the decoding bus. When enabled, the bus label will be displayed at the upper-left side of the bus (when the bus display is enabled). The label shows the current bus type.

17.9.3 Event Table

Open or Close the Event Table

Click or tap the ON/OFF tab for the **Event Table** menu to enable or disable the display of the event table. When enabled, the following event table is displayed, as

shown in the figure below. You can also click or tap the icon  at the upper-right corner of the table to close the event table.

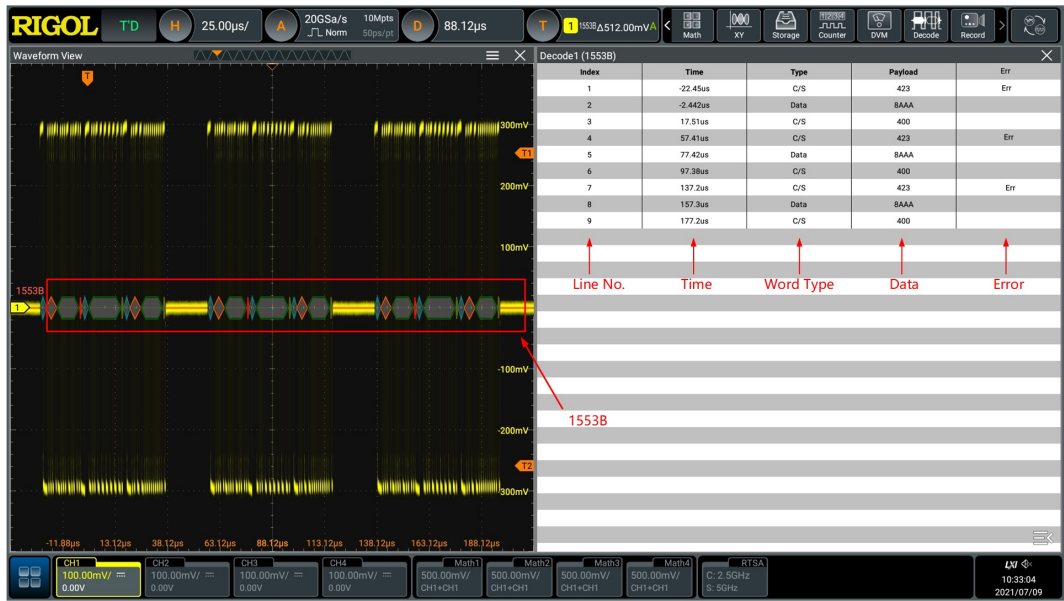

Figure 17.25 1553B Decoding Event Table



TIP

- When you adjust the horizontal time base, the waveform displayed on the screen will also change, and the total number of lines containing the decoding information in the event table will also be changed.
- The displayed decoded data information in the bus is related to the value of the horizontal time base. Reducing the horizontal time base can help you view the detailed information.

Set the Event Table Format

Click or tap the drop-down button of **Format** to select the display format of "Data" in the event table from the drop-down list. The available options include "Hex", "Dec", "Bin", or "ASCII".

Interpret the Decoded 1553B Data

- C/S: command/status word. It is expressed in "C/S" form.
- RTA: remote terminal address of the command/status word. It is expressed in "RTA:" form.
- C/S data: the rest data value of the command/status word. Its display format is the same as that of the bus data (Hex, Dec, Bin, or ASCII), displayed as "C/S:".
- Parity bit: displayed as a yellow-green patch; when errors occur, displayed as a red patch.

- Data word data: data of the data word. Its display format is the same as that of the bus data (Hex, Dec, Bin, or ASCII), displayed as "Data:".

18 Serial Bus Compliance Analysis (Option)



DS70000 series supports serial bus compliance analysis.

If you have purchased the Compliance Test option, activate it according the descriptions in [To View the Option Information and the Option Installation](#).

18.1 USB2.0 Compliance Analysis

This series oscilloscope supports USB2.0 signal quality compliance analysis function. It is available to use when you have purchased and activated the DS70000-USBC option.

To enter the "USB2.0 Compliance Analysis" interface, perform the following operations.

- Click or tap  > **USB2.0 Analysis** to enter the "USB2.0 Compliance Analysis" interface.
- Click or tap  > **Windows** (you can also click or tap the **Windows** icon on the quick operation toolbar at the upper-right corner of the screen) to enter the "Add Window" interface, as shown in [Figure 19.1](#).

Click or tap to select **USB Analysis** under the Diagram menu. Its preview and parameter setting item is displayed at the upper part of the "Add Window"

interface. Click or tap  at the upper-right corner of the window to enter the "USB2.0 Compliance Analysis" menu.

You can select the DUT, configure the acquired signal information, save and analyze the test results.



TIP

This function works with the fixture. For the specific fixture type, software, and test connection diagram, please refer to [USB 2.0 Signal Quality Compliance Test Fixture](#).

18.1.1 DUT

In the **DUT** tab, select the desired type under "DUT", "Signal Type", and "Test Point".

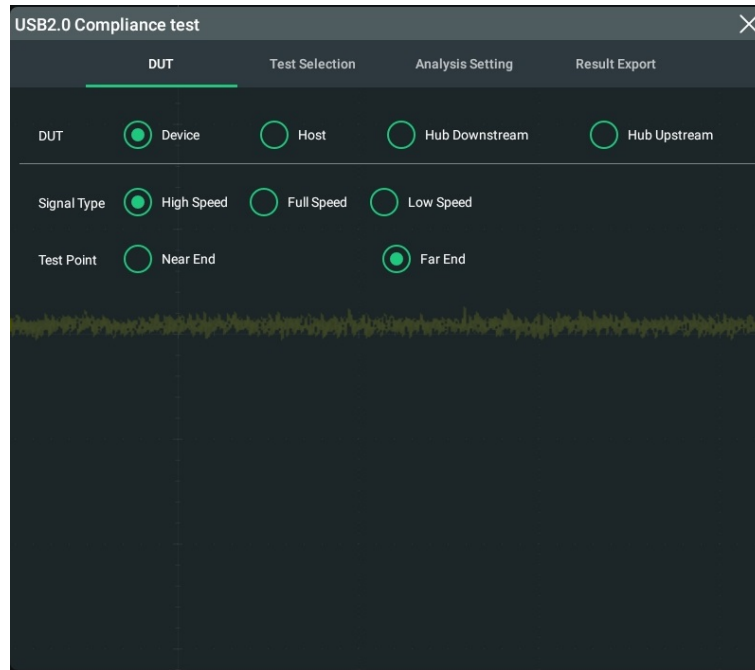

DUT

Selects "Device", "Host", "Hub Downstream", or "Hub Upstream".

Signal Type

Selects "High Speed", "Full Speed", or "Low Speed".

Test Point

When the signal type is "High Speed", you can select "Near End" or "Far End" as the test point according to the test scenario. Whether you select "Near End" or "Far End", it determines the test port of the DUT, as shown in the figure below.

- "Near End" should be selected in the following conditions: no USB cable is available before the the DUT and the host; the test point is located in TP3; Template1 is selected for the eye template according to USB2.0 protocol.
- "Far End" should be selected in the following conditions: A USB cable is available before the the DUT and the host; the test point is located in TP2; Template2 is selected for the eye template according to USB2.0 protocol.

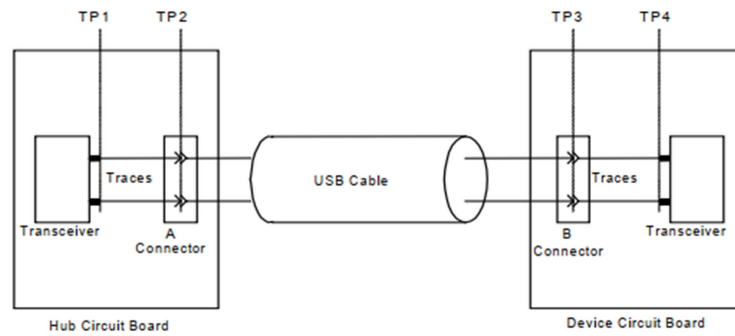
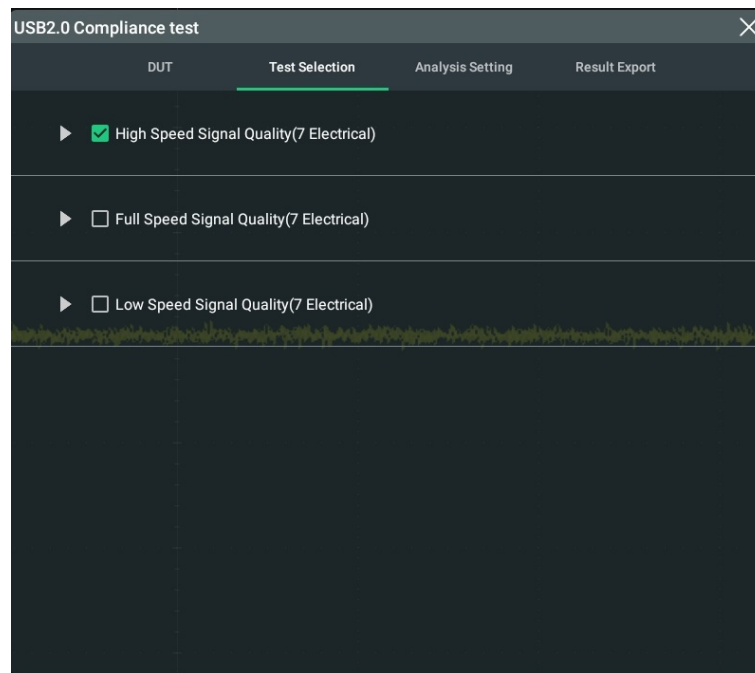

Figure 18.1 USB2.0 Test Model

18.1.2 Test Selection

Click or tap the **Test Selection** tab to select the desired item. When you select a different signal type in the **DUT** tab, the default test selection item is different.



High Speed Signal Quality(7 Electrical)

When you select "High Speed" for the "Signal Type" in the "DUT" tab, "High Speed Signal Quality(7 Electrical)" is selected, by default, under the Test Selection tab. Click or tap the "Triangle" icon to unfold the test items. The following table lists the measuring items, Maximum, Minimum, and Standard Number of the high speed signal.

Table 18.1 High-speed Signal Quality Compliance Test Item

Measuring Item	Minimum	Maximum	Standard Number
SYNC Width	32 bits	32 bits	EL_2
EOP Width	39.5 bits (7.5 bits) ^[1]	40.5 bits (8.5 bits) ^[1]	EL_2
Signal Rate	479.76 Mb/s	480.24 Mb/s	EL_2
Rise Time	500 ps	N/A	EI_2
Fall Time	500 ps	N/A	EL_2
Edge Monotonicity	0	50 mV	EL_7
Rise Edge Rate	N/A	1600 V/us	EI_2
Fall Edge Rate	N/A	1600 V/us	EI_2
Paired JK Jitter	-100 ps	100 ps	EI_4
Paired KJ Jitter	-100 ps	100 ps	EI_4
Consecutive Jitter	-100 ps	100 ps	EI_4
Signal Eye Violation Points	0	0	EI_4

NOTE

[1]: data enclosed by brackets in the EOP Width field are non-start frame data.

**Full Speed Signal Quality(7 Electrical)**

When you select "Full Speed" for the "Signal Type" in the "DUT" tab, "Full Speed Signal Quality(7 Electrical)" is selected, by default, under the Test Selection tab. Click or tap the "Triangle" icon to unfold the test items. The following table lists the measuring items, Maximum, Minimum, and Standard Number of the full speed signal.

Table 18.2 Full-speed Signal Quality Compliance Test Item

Measuring Item	Minimum	Maximum	Standard Number
SYNC Width	8 bits	8 bits	EL_2

Measuring Item	Minimum	Maximum	Standard Number
EOP Width	160 ns	175 ns	EL_2
Signal Rate	11.97 Mb/s	12.03 Mb/s	EL_2
Rise Time	4 ns	20 ns	EL_2
Fall Time	4 ns	20 ns	EL_2
Cross Volt	1.3 V	2.0 V	EL_2
Rise Edge Rate	100 V/us	720 V/us	EL_2
Fall Edge Rate	100 V/us	720 V/us	EL_2
Paired JK Jitter	-1 ns	1 ns	EL_4
Paired KJ Jitter	-1 ns	1 ns	EL_4
Consecutive Jitter	-2 ns	2 ns	EL_4
Signal Eye Violation Points	0	0	EL_4

Low Speed Signal Quality(7 Electrical)

When you select "Low Speed" for the "Signal Type" in the "DUT" tab, "Low Speed Signal Quality(7 Electrical)" is selected, by default, under the Test Selection tab. Click or tap the "Triangle" icon to unfold the test items. The following table lists the measuring items, Maximum, Minimum, and Standard Number of the low speed signal.

Table 18.3 Low-speed Signal Quality Compliance Test Item

Measuring Item	Minimum	Maximum	Standard Number
SYNC Width	8 bits	8 bits	EL_2
EOP Width	1.25 us	1.5 us	EL_2
Signal Rate	1.4775 Mb/s	1.5225 Mb/s	EL_2
Rise Time	75 ns	300 ns	EL_2
Fall Time	75 ns	300 ns	EL_2
Cross Volt	1.3 V	2.0 V	EL_2

Measuring Item	Minimum	Maximum	Standard Number
Rise Edge Rate	6.67 V/us	38.4 V/us	EL_2
Fall Edge Rate	6.67 V/us	38.4 V/us	EL_2
Paired JK Jitter	-10 ns	10 ns	EL_4
Paired KJ Jitter	-10 ns	10 ns	EL_4
Consecutive Jitter	-25 ns	25 ns	EL_4
Signal Eye Violation Points	0	0	EL_4

18.1.3 Analysis Setting

Click or tap the **Analysis Setting** tab. In the **Analysis Setting** interface, select the connection mode, source, and view the configuration information.

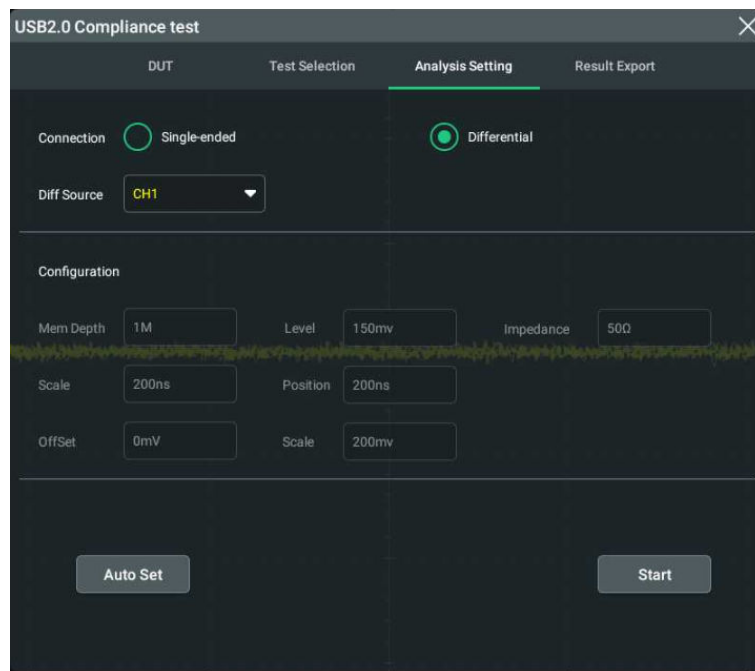

Connection

- When performing the "high speed" signal quality compliance test, you need to select "Single-ended" or "Differential" for the "Connection" item.
- When performing the "low speed" or "full speed" signal quality compliance test, select "Single-ended" for the "Connection" item.

Source

- When "Single-ended" is selected,
 - Click or tap the drop-down button of "Source Dp" to select the desired channel (CH1, CH2, CH3, or CH4).
 - Click or tap the drop-down button of "Source Ds" to select the desired channel (CH1, CH2, CH3, or CH4).
- When "Differential" is selected,
 - Click or tap the drop-down button of "Differential" to select the desired channel (CH1, CH2, CH3, or CH4).

Signal Configuration

The configuration information is different for different types of the signal types, as shown in the following table.

Table 18.4 Signal Configuration

Configuration	High Speed Signal	Full Speed Signal	Low Speed Signal
Memory Depth	1 M	1 M	1 M
Trigger Level	150 mV	1 V	1 V
Impedance	50 Ω	1 M Ω	1 M Ω
Scale	200 ns/div	1 us/div	10 us/div
Offset	200 ns	3 us	30 us
Position	0 mV	0 mV	0 mV
Scale	200 mV/div	1000 mV/div	1000 mV/div

Auto Set

Click or tap **Auto Set** to configure the signal information automatically.

Launch the Test

Click or tap **Start** to start the USB2.0 signal quality compliance analysis test.

18.1.4 Result Export

In the **Result Export** tab, you can view or save the USB2.0 signal quality compliance analysis test results.

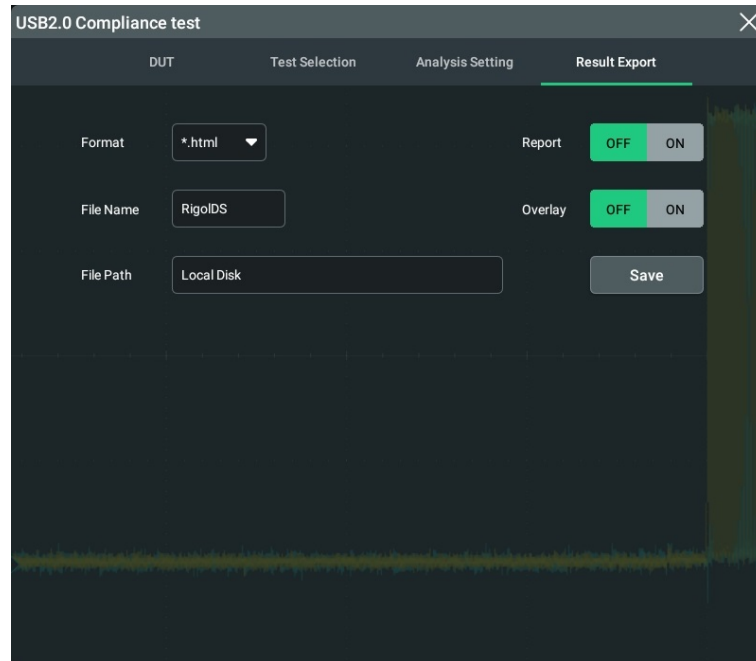

Format

Displays the saved file format. It is saved in "*.html" format.

Report

Click or tap ON or OFF under "Report" to enable or disable the display of the analysis report. When enabled, the test report results are displayed at the right section of the screen.



Figure 18.2 USB2.0 Signal Quality Compliance Analysis Test Result

Set the File Saving Parameters

- Set the filename

Click or tap the input field of **File Name** to input the file name to be saved with the pop-up virtual keypad.

- **Set the file path**

Click or tap the input field of **File Path**, then the disk management interface is displayed. You can click or tap the saved file to view the saved image file. For detailed operations, refer to descriptions in *Disk Management*.



- **Overlay**

Click or tap the ON/OFF button for the **Overlay** menu to enable or disable the overwriting function. When enabled, the existing file in the specified file path will be overwritten by the newly saved file that has the same filename as the existing one.

18.2 LAN Compliance Analysis

This series oscilloscope supports Ethernet signal quality compliance analysis function. It is available to use when you have purchased and activated the DS70000-ENETC option.

To enter the "LAN Compliance Analysis" interface, perform the following operations.

- Click or tap  > **LAN Analysis** to enter the "LAN Compliance Analysis" interface.
- Click or tap  > **Windows** (you can also click or tap the **Windows** icon on the quick operation toolbar at the upper-right corner of the screen) to enter the "Add Window" interface, as shown in *Figure 19.1*.

Click or tap to select "LAN Analysis" under the **Diagram** menu. Its preview and parameter setting item is displayed at the upper part of the "Add Window" interface. Click or tap the drop-down button of **Type** to select "100Base-T" or "1000Base-T", then click or tap **Add**. The "100Base-T Test Results" or "1000Base-

T Test Results" window is displayed. Click or tap  at the upper-right corner of the window to enter the "LAN Compliance Analysis" menu.



TIP

This function works with the LAN signal compliance analysis fixture. For the specific fixture type, software, and test connection diagram, please refer to *Ethernet Compliance Analysis Test Fixture (TF-ENET-STP User Guide)*.

18.2.1 To Select the Signal Type

In the "LAN Compliance Analysis" interface, click or tap the drop-down button of **Signal Type** to select the desired signal type.

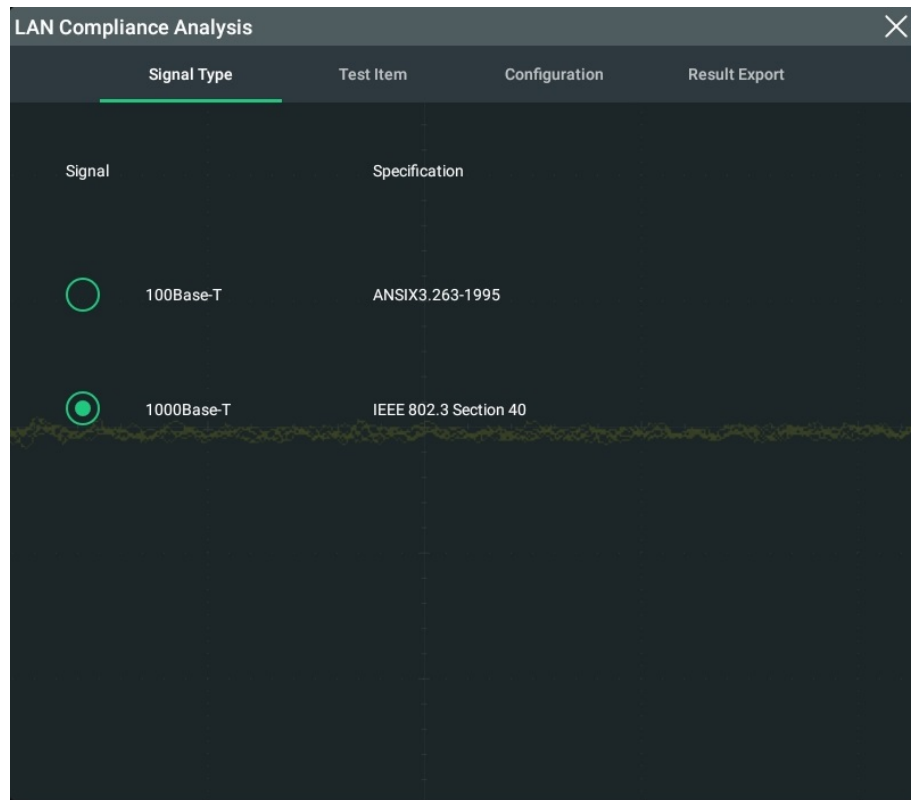





Figure 18.3 Signal Type

Click or tap the specified signal type to perform the LAN compliance analysis test.

- 100Base-T: indicates the 100Base-T signal which complies with the protocol ANSIX3.263-1995.
- 1000Base-T: indicates the 1000Base-T signal which complies with the protocol IEEE 802.3 Section40.

18.2.2 To Select the Test Item

After selecting the signal type, click or tap **Test Item** in the "LAN Compliance Analysis" interface to enter the test item menu, as shown in [Figure 18.4](#) and [Figure 18.5](#). The test items for the 100Base-T and 1000Base-T signals are different.

Click or tap the icon  to unfold all the sub-items. Click or tap to select the checkbox . When it turns out be , the specified test item is selected.

18.2.2.1 100Base-T Signal Test Items

Select 100Base-T as the signal type. The Test Item menu is shown in the following figure.

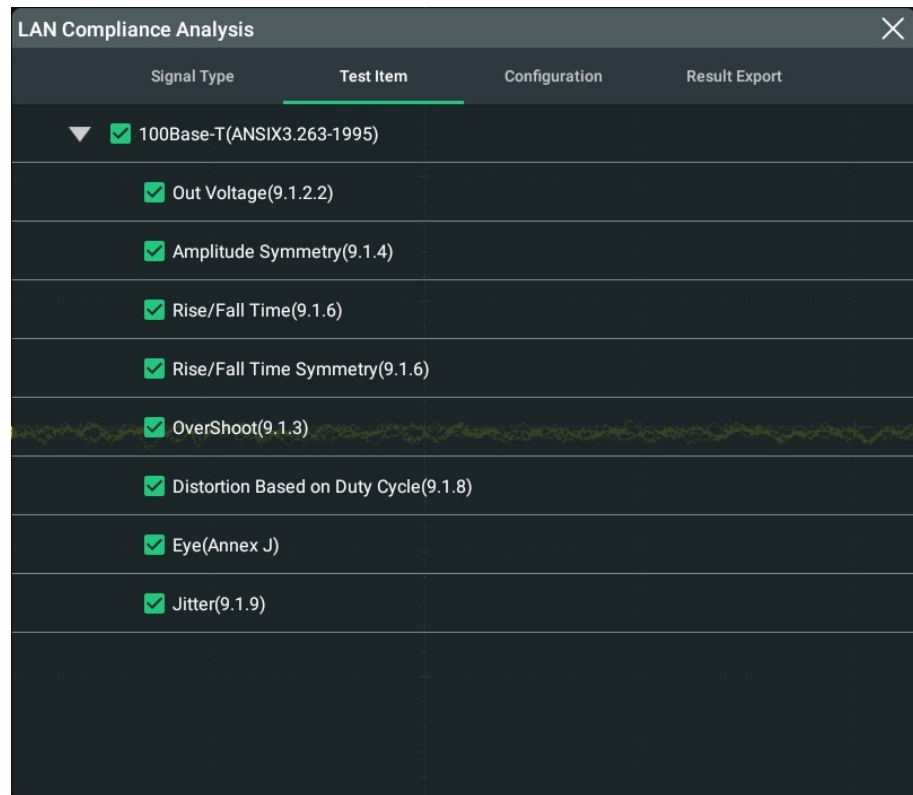

Figure 18.4 100Base-T Signal Test Items

The pass conditions for the test items are shown in the following table.

Table 18.5 Pass Conditions for the Test Items of the 100Base-T Signal Type

Test Item	Description	Pass Conditions	
		Min.	Max.
Out Voltage	+Vout	950 mV	1050 mV
	-Vout	-1050 mV	-950 mV
Amplitude Symmetry	Signal Amplitude Symmetry	0.98	1.02
Rise/Fall Time	Rise Time Test for Positive Pulse (+Ve)	3 ns	5 ns
	Rise Time Test for Negative Pulse (-Ve)		
	Fall Time Test for Positive Pulse (+Ve)		

Test Item	Description	Pass Conditions	
		Min.	Max.
	Fall Time Test for Negative Pulse (-Ve)		
Rise/Fall Time Symmetry	Rise/Fall Time Symmetry Test for Positive Pulse (+Ve)	0 ps	500 ps
	Rise/ Fall Time Symmetry Test for Negative Pulse (-Ve)		
OverShoot	Overshoot Test for Positive Pulse (+Ve)	0%	5%
	Overshoot Test for Negative Pulse (-Ve)		
Distortion Based on Duty Cycle	Duty Distortion Test	0 ps	500 ps
Eye	Eye Diagram	N/A	N/A
Jitter	Jitter Test with Positive Polarity (+Ve)	0 ns	1.4 ns
	Jitter Test with Negative Polarity (-Ve)		

18.2.2.2 1000Base-T Signal Test Items

Select 1000Base-T as the signal type. The Test Item menu is shown in the following figure.

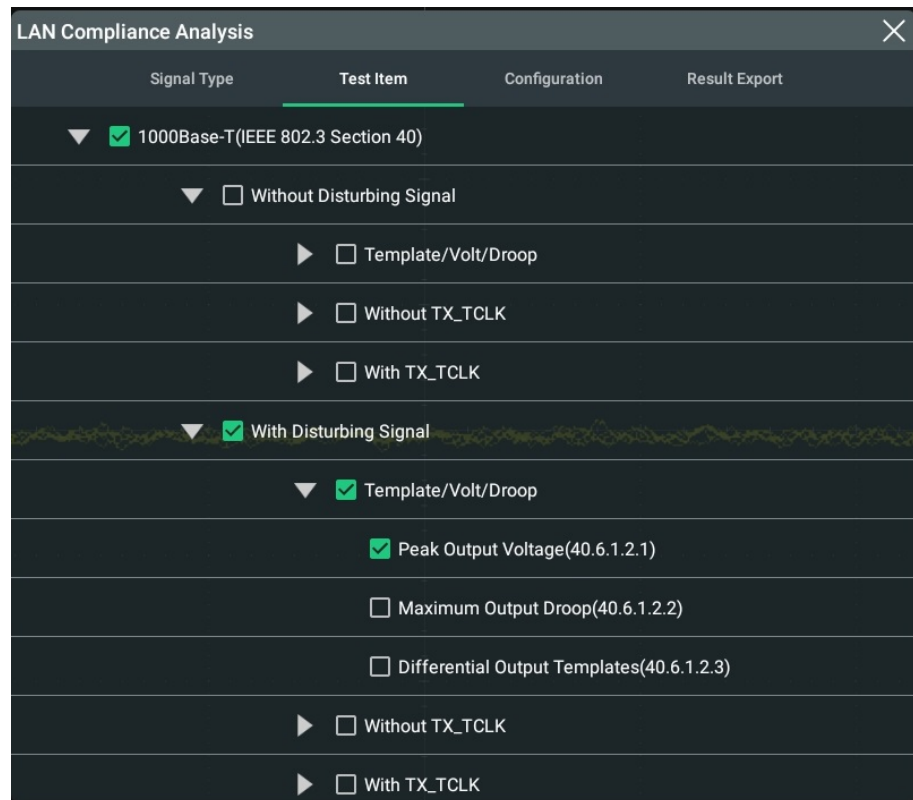

Figure 18.5 1000Base-T Signal Test Items

According to the rules of IEEE 802.3 standards for the 1000BASE-T physical layer compliance test, the DUT is required to perform a series of compliance testings in the four test modes. In the generated analysis report, you can query the pass/fail condition and test results of each test project. To obtain the report, refer to [Result Report](#).

Test Mode 1

Includes Voltage, Droop, and Template.

- Peak Output Voltage (40.6.1.2.1)
- Maximum Output Droop(40.6.1.2.2)
- Differential Output Templates (40.6.1.2.3)

Two test scenarios: With Disturbing Signal and Without Disturbing Signal

- Without Disturbing Signal > Template/Volt/Droop:

Test Mode 1 under the scenario without the disturbing signal

- With Disturbing Signal > Template/Volt/Droop:

Test Mode 1 under the scenario with the disturbing signal

Test Mode 1 needs to test A, B, C, D, F, G, H, and J test points of the waveforms.

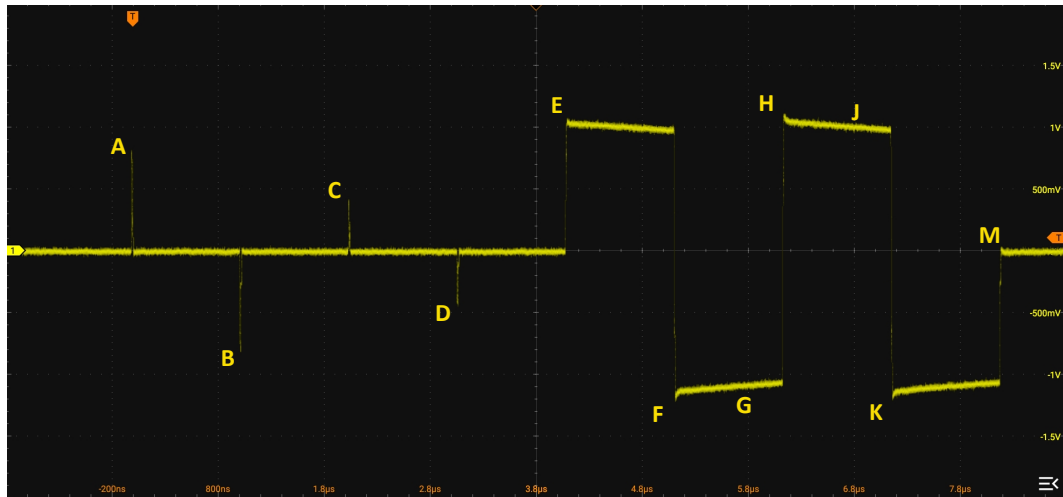

Figure 18.6 Typical Waveform of Test Mode 1 Signal

The pass conditions for the test item are shown in the following table.

Table 18.6 Pass Conditions for Test Mode 1

Test Item	Test Contents	Pass Conditions	
		Min.	Max.
Peak Output Voltage	Peak Differential Output Voltage A	0.67 V	0.82 V
	Peak Differential Output Voltage B		
	% Diff A & B	0%	1%
	% Diff C & (A and B)	0%	2%
	% Diff D & (A and B)		
Differential Output Templates	Test A, B, C, D, F, and H	-	-
Maximum Output Droop	Max. Output Droop (Point F and Point G)	73.1%	-
	Max. Output Droop (Point H and Point J)		

Test Mode 2

Includes the Jitter Master Mode test. Four test scenarios are available based on whether having the clock signal or being filtered.

- Without TX_TCLK > Unfiltered Jitter Master Mode (40.6.1.2.5):
Jitter Master Mode test without the clock signal and unfiltered
- Without TX_TCLK > Filtered Jitter Master Mode (40.6.1.2.2):
Jitter Master Mode test without the clock signal and filtered
- With TX_TCLK > Unfiltered Jitter Master Mode (40.6.1.2.5):
Jitter Master Mode test with the clock signal and unfiltered
- With TX_TCLK > Filtered Jitter Master Mode (40.6.1.2.2):
Jitter Master Mode test with the clock signal and filtered

Table 18.7 Pass Conditions for Test Mode 2

Test Item	Clock Signal	Filter	Pass Conditions	
			Min.	Max.
Jitter Master Mode	Without TX_TCLK	Unfiltered	0 ns	1.4 ns
	Without TX_TCLK	Filtered	0 ns	0.3 ns
	With TX_TCLK	Unfiltered	0 ns	1.4 ns
	With TX_TCLK	Filtered	0 ns	0.3 ns

Test Mode 3

Includes the Jitter Slave Mode test. Four test scenarios are available based on whether having the clock signal or being filtered.

- Without TX_TCLK > Unfiltered Jitter Slave Mode (40.6.1.2.5):
Jitter Slave Mode test without the clock signal and unfiltered
- Without TX_TCLK > Filtered Jitter Slave Mode (40.6.1.2.2):
Jitter Slave Mode test without the clock signal and filtered
- With TX_TCLK > Unfiltered Jitter Slave Mode (40.6.1.2.5):
Jitter slave mode test with the clock signal and unfiltered
- With TX_TCLK > Filtered Jitter Slave Mode (40.6.1.2.2):
Jitter Slave Mode test with the clock signal and filtered

Table 18.8 Pass Conditions for Test Mode 3

Test Item	Clock Signal (TX_TCLK)	Filtered/Unfiltered	Pass Conditions	
			Min.	Max.
Jitter Slave Mode	Without TX_TCLK	Unfiltered	0 ns	1.4 ns
	Without TX_TCLK	Filtered	0 ns	0.4 ns
	With TX_TCLK	Unfiltered	0 ns	1.4 ns
	With TX_TCLK	Filtered	0 ns	0.4 ns

Test Mode 4

Includes the transmitter distortion and common-mode output voltage tests.

- Transmitter Distortion (40.6.1.2.4):
- Common > Common-mode Output Voltage (40.8.3.3):

Four test scenarios are available for transmitter distortion based on whether having the clock signal and the disturbing signal.

- Without Disturbing Signal > Without TX_TCLK:
Transmitter distortion test without disturbing signal and without the clock signal
- Without Disturbing Signal > With TX_TCLK:
Transmitter distortion test without disturbing signal and with the clock signal
- Without Disturbing Signal > Without TX_TCLK:
Transmitter distortion test with disturbing signal and without the clock signal
- Without Disturbing Signal > Without TX_TCLK:
Transmitter distortion test with disturbing signal and with the clock signal

Table 18.9 Pass Conditions for Test Mode 4

Test Item	Pass Conditions	
	Min.	Max.
Transmitter Distortion	0 mV	10 mV
Common-mode Output Voltage	0 mV	50 mV

18.2.3 Configuration Menu

After selecting a test item, click or tap the **Configuration** tab to enter the Configuration menu, as shown in the following figure.

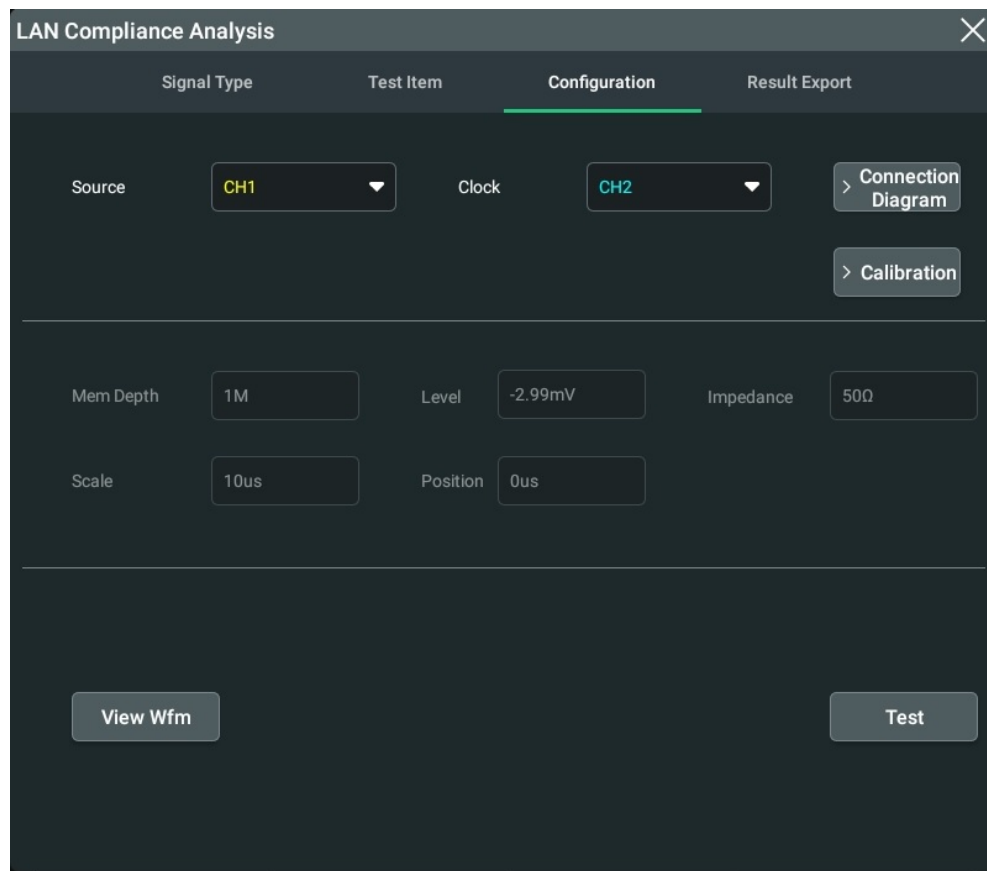

Figure 18.7 Configuration Menu

18.2.3.1 To Configure the Source

As the test signals required for different test items in the LAN compliance analysis test are different, you need to configure different sources for different test items. For DS70000, the available source channels are CH1-CH4.



TIP

The source configuration shall be consistent with the source specified in the test connection diagram.

Configure the Source

For the following test items, only one source channel is required to be configured to obtain the data signal under test.

- All the test items of the 100Base-T signal.

- The following test items of the 1000Base-T signal. They include
 - Without Disturbing Signal > Template/Volt/Droop
 - With Disturbing Signal > Template/Volt/Droop
 - Without Disturbing Signal > Without TX_TCLK > Transmitter Distortion
 - With Disturbing Signal > Without TX_TCLK > Transmitter Distortion
 - Common > Common-mode Output Voltage

Configure the Source and the Clock Source

For the following test items, you need to configure one source channel to obtain the data signal and one clock source to obtain the clock signal. The channels selected for the source channel and the clock channel should differ.

- Without Disturbing Signal > With TX_TCLK > Transmitter Distortion
- With Disturbing Signal > With TX_TCLK > Transmitter Distortion

Configure the Data Source

In the jitter test without the clock signal, only one source channel is required to be configured to obtain the data source in the master or slave mode.

- Without TX_TCLK > Unfiltered Jitter Master Mode
- Without TX_TCLK > Unfiltered Jitter Slave Mode
- Without TX_TCLK > Filtered Jitter Master Mode
- Without TX_TCLK > Filtered Jitter Slave Mode

Configure the Master Clock Source

In the unfiltered jitter master test with the clock signal, only one master clock source is required to be configured to obtain the clock signal in the jitter master mode.

Test item: With TX_TCLK > Unfiltered Jitter Master Mode

Configure the Master Clock Source and the Slave Clock Source

In the unfiltered jitter slave test with the clock signal, configure one master clock source and one slave clock source to obtain the clock signal in the jitter master mode and jitter slave mode respectively. The channels selected for master clock source and slave clock source are different.

Test item: With TX_TCLK > Unfiltered Jitter Slave Mode

Configure the Master Clock Source and the Data Source

In the filtered jitter master test with the clock signal, you need to switch the device under test. The test signals obtained before and after switching the device are different.

- Before switching the device, obtain the clock signal of the master device working in normal mode.
- After switching to another device, obtain the clock signal and data signal of the device working in master mode. Configure one master clock source and one data source. The channels for the two sources are different.

Test item: With TX_TCLK > Filtered Jitter Master Mode

Configure the Data/Master Clock Source and the Slave Clock Source

In the filtered jitter slave test with the clock signal, you need to switch the device under test. The test signals obtained before and after switching the device are different.

- Before switching the device, obtain the clock signal of the master device and the slave device working in normal mode. One master clock source and one slave clock source are required to be configured. The channels for the two sources are different.
- After switching to another device, obtain the clock signal and data signal of the device working in slave mode. Configure one data source and one slave clock source respectively. The channels selected for data source and slave clock source are different.

Test item: With TX_TCLK > Filtered Jitter Slave Mode

18.2.3.2 Connection Diagram

In the Configuration menu, click or tap **Connection Diagram** to enter the Connection Diagram menu, as shown in the figure below. The diagram shows the connection methods for the specified test item and the corresponding test procedures, guiding you to perform the test.

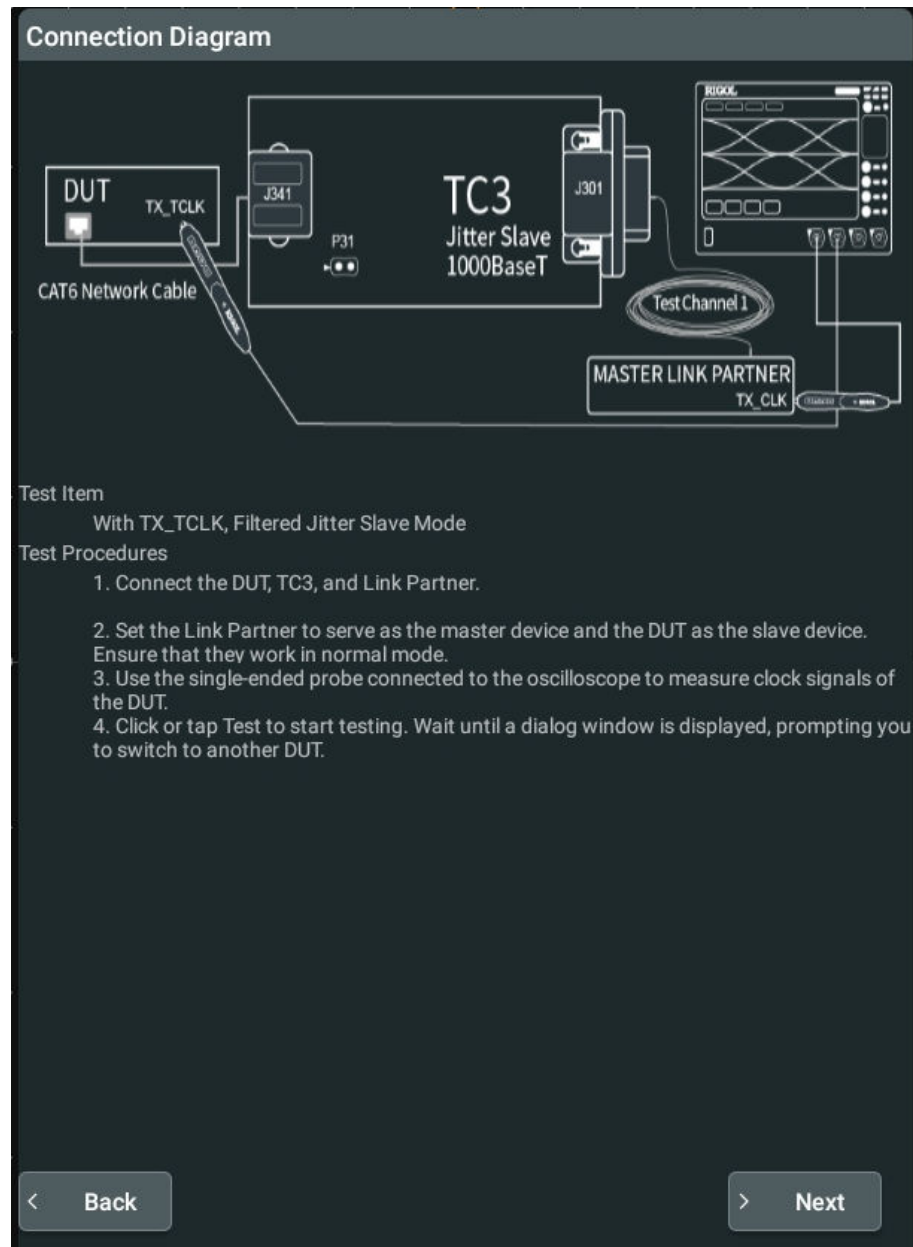

Figure 18.8 Connection Diagram

Click or tap **Back** to return to the Configuration menu.

In the filtered jitter master/slave mode with the clock signal, you need to switch the device. In the Connection Diagram menu, click or tap **Next** or **Last** to view the connection diagram and test procedures after switching the device or before switching the device.

18.2.3.3 Fixture Calibration

In the Configuration menu, click or tap **Calibration** to enter the fixture calibration menu, as shown in the figure below.

The screenshot shows a 'DUT Calibration' dialog box with a close button (X) in the top right corner. It is divided into two main sections: 'Disturbing Signal' and 'DUT Calibration'.

Disturbing Signal Section:

	Expected Value	Measured Value	Action
Frequency	31.25MHz	31.25MHZ	Measure
Amplitude	1.4V	1.40V	Default

DUT Calibration Section:

	Expected Value	Measured Value	Action
TC2 Amplitude	750mV	750.00mV	Measure
TC5 Amplitude	500mV	500.00mV	Measure
Amplitude Attenuati	1.5X	1.50X	Default

At the bottom of the dialog, there are three buttons: '< Back', 'Apply', and '> Connection Diagram'.

Figure 18.9 Fixture Calibration

For the test items with the disturbing signal, perform calibration for the disturbing signal and the fixture.

Connection Diagram

In the Calibration menu, click or tap **Connection Diagram** to enter the Connection Diagram menu. The Connection Diagram interface shows the calibration connection diagram for the disturbing signal, TC2, and TC5. Below the diagram are the calibration procedures. You can drag up and down the page to view the complete information.

Click or tap **Back** to return to the Fixture Calibration menu.

Calibration for Disturbing Signals

The Expected Value shows the ideal frequency and amplitude value of a disturbing signal.

Connect the device for calibrating the disturbing signal according to the connection diagram, then perform the test according to the test procedures. Click or tap **Test** to start testing for the actual disturbing signal. After completing the test, the measured

frequency and amplitude values of the disturbing signal are displayed in the "Measured Value" field. Compare the measured value and the expected value. If they are not close to each other, modify the amplitude and frequency of the disturbing signal to test again until they are approximately equivalent.

If the disturbing signal does not need to be calibrated, click or tap **Default**, and the expected value will be used as the measured value of the disturbing signal.

Fixture Calibration

The Expected Value field shows the ideal measured value of the TC2 amplitude, TC5 amplitude, and amplitude attenuation.

Connect the device for calibrating TC2 and TC5 according to the connection diagram, then perform the test according to the test procedures. Click or tap **Test** to start testing. After completing the test, the measured TC2 amplitude value, TC5 amplitude value, and amplitude attenuation value are displayed in the "Measured Value" field.

If the fixture does not need to be calibrated, click or tap **Default**, and the expected value will be used as the measured value of TC2 and TC5.

Apply

After completing the test for the disturbing signal, TC2, and TC5, click or tap **Apply** to complete the calibration configuration.

Back

Click or tap **Back** to return to the Configuration menu.

18.2.3.4 To Launch the Test

In the "Configuration" tab, you can preview the current test waveform and view the current waveform configuration parameters. You can also launch the test for the specified test item.

Preview the Waveform

Click or tap **View Wfm** to preview the waveform for the specified test item in the waveform view to ensure that the waveform is properly output.

Launch the Test

Click or tap **Test** to start the LAN compliance analysis test.

Configure Parameters

After the specified signal type and test item are selected, the waveform parameters of the oscilloscope such as level, scale, and impedance can be seen in the Configuration menu, as shown in *Figure 18.7*. The configuration parameters for different test items are different.

**TIP**

These parameters displayed in the "Configuration" menu are the parameters for the previewed test waveform. After starting the test, the parameters will be automatically adjusted.

18.2.4 Result Report

You can view the LAN compliance analysis test report of the DS70000 series and save it to the local path.

In the "LAN Compliance Analysis" interface, click or tap **Result Export** to enter the result export menu.

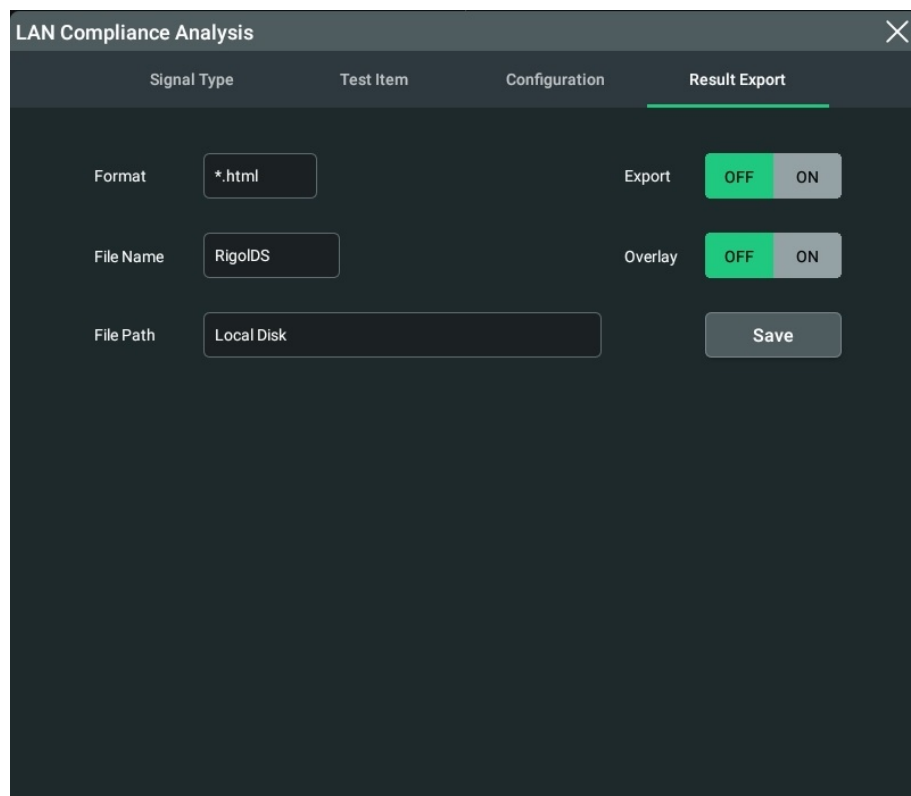
**Format**

The report can only be saved in "*.html" format.

Result Report

Click or tap ON or OFF under "Report" to enable or disable the display of the analysis report. When enabled, the test report results as shown in the figure below are displayed at the right section of the screen.

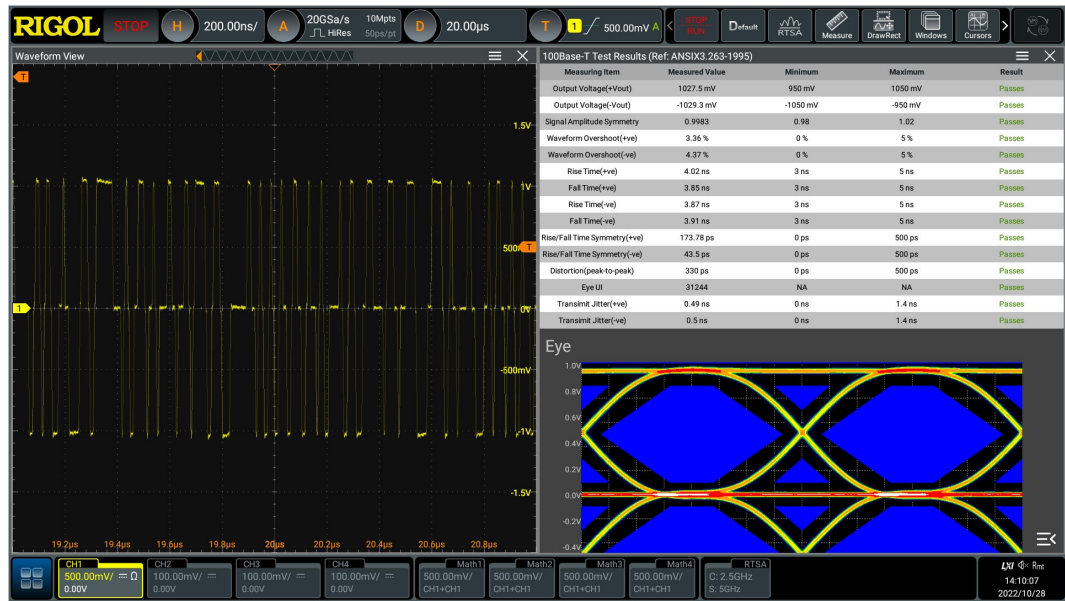

Figure 18.10 LAN Compliance Analysis Test Report

Set the File Saving Parameters

- **Set the filename**

Click or tap the input field of **File Name** to input the file name to be saved with the pop-up virtual keypad.

- **Set the file path**

Click or tap the input field of **File Path**, then the disk management interface is displayed. You can click or tap the saved file to view the saved image file. For detailed operations, refer to descriptions in *Disk Management*.

- **Overlay**

Click or tap the ON/OFF button for the **Overlay** menu to enable or disable the overwriting function. When enabled, the existing file in the specified file path will be overwritten by the newly saved file that has the same filename as the existing one.

19 Multi-pane Windowing

DS70000 supports multi-pane windowing. Users can add multiple windows and result display windows for display and view.

Click or tap the function navigation icon  at the lower-left corner of the screen. Then click or tap **Windows** to enter the "Add Window" interface. You can also click or tap the "Windows" icon in the quick operation bar at the top of the screen to enter the "Add Window" interface. As shown in the figure below:

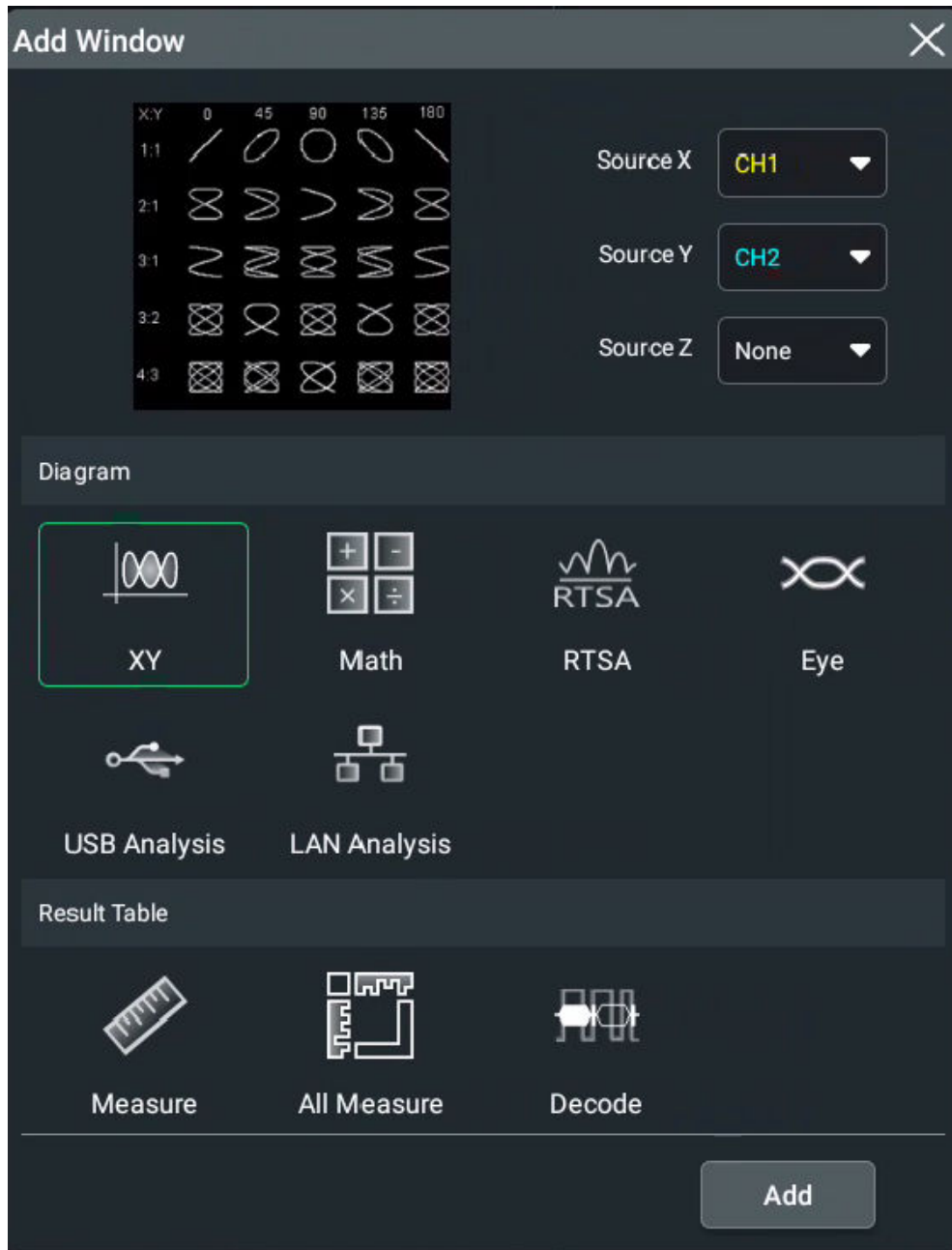

Figure 19.1 "Add Window" Menu

Add Diagram Windows

1. First, click or tap "XY", "Math", "RTSA", "Eye", "USB Analysis", or "LAN Analysis" under the **Diagram** menu. When a diagram is selected, its preview and parameter setting items can be displayed at the upper part of the "Add Window" interface.
2. You can set the corresponding parameters according to your needs. For detailed setting methods, refer to descriptions of relevant chapters.
3. Click or tap **Add**, then the selected diagram is displayed on the screen.

Add Result Table Window

Click or tap "**Measure**", "**All Measure**", or "**Decode**" under the **Result Table** menu, then click or tap **Add**. The corresponding measurement results will be displayed on the screen.

20 Waveform Recording and Playing

Waveform recording/playing function can play the recorded waveforms of the analog input channels (CH1-CH4), enabling you to analyze the waveforms better.

20.1 Common Settings

Click or tap the function navigation icon  at the lower-left corner of the screen to open the function navigation. Then, click or tap the **Record** icon to enter the "Record" menu. You can also tap the **Record** icon on the small screen at the right side of the front panel or the quick operation bar at the top of the screen to enter the "Record" menu.

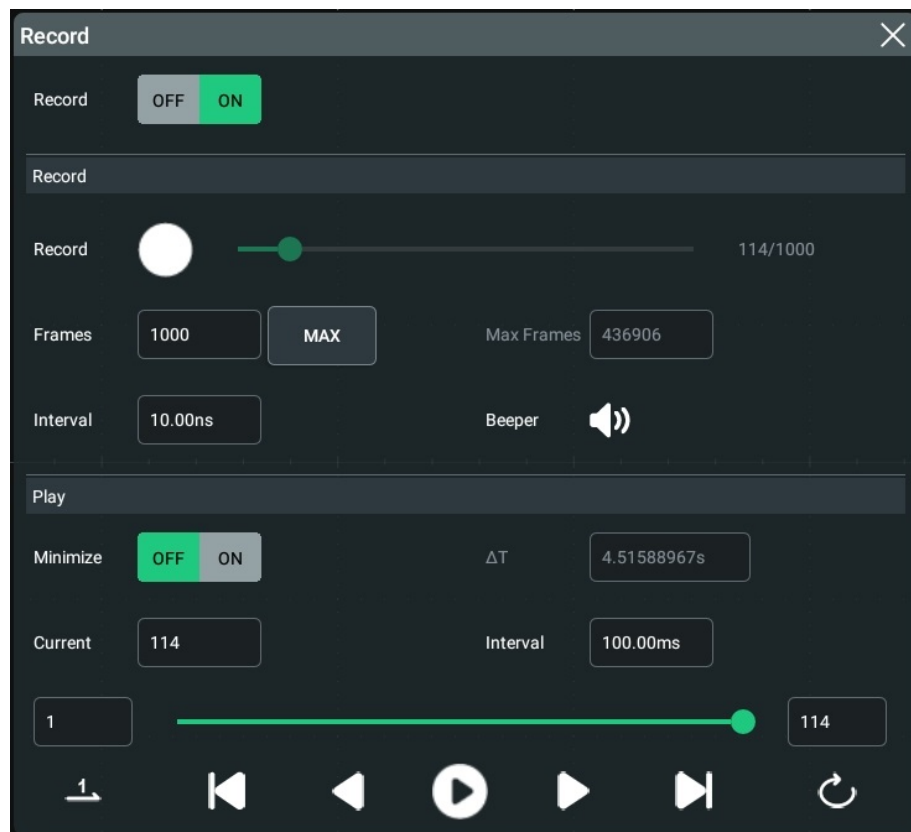









Figure 20.1 Waveform Recording Interface



1. Recording Operation

Click or tap the ON/OFF tab for the **Record** menu to enable or disable the waveform recording function. Before recording the waveform, you can refer to descriptions in *Record Options* to set the waveform recording parameters.

- Click or tap the **Record** button  under the **Record** menu to start recording the waveforms. Then the record icon turns  from .
- During the recording, you can view the recording information under the **Play** menu. In the **Play** menu, the input field of **Current** shows the number of currently recorded frames. Under **Current** is the play progress bar. The left input field is the start frame and the right input field is the total number of currently recorded frames. ΔT indicates the time interval between the current frame and the first frame during the recording process.
- After the recording is completed,  turns out to be  and recording stops automatically.
- During recording, you can also click or tap  to suspend recording manually.

2. Play Operation

Click or tap the play icon  under **Play** to start playing the recorded waveforms.

Then the play icon turns from the play action  to the pause action . For details about playing, refer to descriptions in *Play Option*. During waveform playing, the value of **Current** changes dynamically. During playing, you can also click or tap the icon  again to suspend playing manually.

20.2 Record Options

During the waveform recording, the oscilloscope records the waveforms of the currently enabled channel at a specified interval until you manually stops the recording operation or the number of recorded frames has reached the set value.

Before recording the waveforms, set the following parameters.

1. Interval

The recording interval indicates the time interval between the frames during the recording process.

Click or tap **Interval**, then use the pop-up numeric keypad to set the time interval between frames. The available range is from 10 ns to 10 s.

2. Frames

The recording frames refer to the number of frames that can be recorded actually. After starting the recording operation, the oscilloscope stops the recording operation automatically when the number of recorded frames reaches the set value.

Click or tap **Frames** to set the number of waveform frames to be recorded currently. The range available is from 1 to the maximum number of frames that can be recorded currently.

3. Max Frames

The input field of **Max Frames** displays the maximum number of frames that can be recorded currently. Click or tap **Max**, and the maximum number of recorded waveform frames is automatically input into the input field of Frames.

As the capacity of the waveform memory is fixed, the more the number of points each frame of waveform has, the less the number of waveform frames that can be recorded. Therefore, the maximum number of recorded frames is related to the currently selected "memory depth" (refer to *Memory Depth*). The current memory depth refers to the number of waveform points per frame. $\text{Memory Depth} = \text{Sample Rate} \times \text{Horizontal Time Base} \times \text{Number of Grids in the Horizontal Direction}$. Therefore, the Max value of waveform recording is also related to the "Sample Rate" and "Horizontal Time Base". This oscilloscope supports up to 2,000,000 frames real-time and ceaseless waveforms recording.

4. Beeper



: the beeper sounds at the end of recording.



: the beeper does not sound at the end of recording.

20.3 Play Option

Waveform playing function can play back the waveforms currently recorded. In **Play** menu, click or tap the ON/OFF tap for the **Minimize** menu to select whether to minimize the window. When you click or tap **ON**, the play window is minimized, making the interface more simplified, easy for observation and operation. As shown in the figure below:

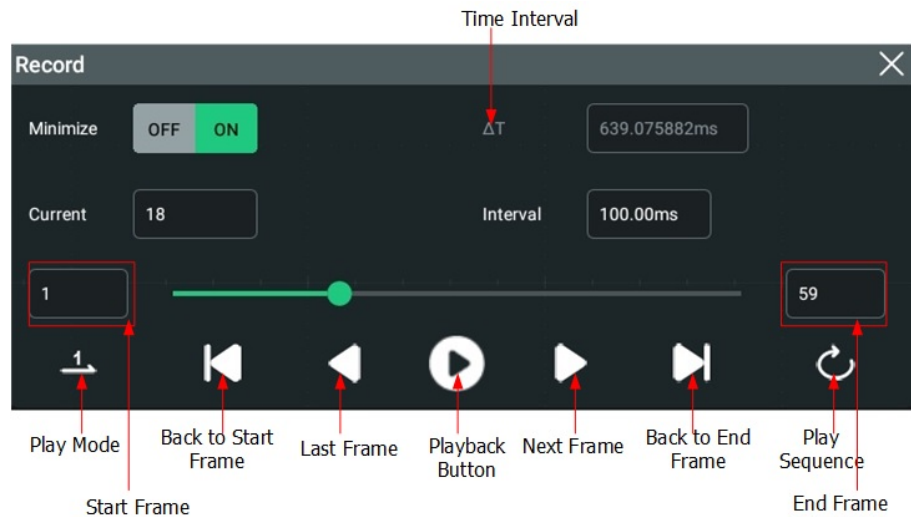

Figure 20.2 Play Operation Interface

Before playing the waveforms, set the following parameters.

1. Play Mode

You can play the waveforms in single mode (1) or cycle mode (↻).

- 1: plays from the start frame to the end frame, and then stops automatically.
- ↻: plays from the start frame to the end frame, then such playback operation is repeated until you stop it manually.

2. Play Sequence

You can play back the waveforms clockwise (↻) or counterclockwise (↺).

- ↻: plays from the start frame to the end frame.
- ↺: plays from the end frame to the start frame.

3. Interval

The playback interval indicates the time interval between the frames during the playing process.

Click or tap **Interval**, then use the pop-up numeric keypad to set the time interval between frames. The available range is from 1 ms to 10 s.

4. Start Frame

Click or tap the input field of "Start Frame" in *Figure 20.2* to set the start frame for playing back the waveforms. The default is 1, and the maximum value is the maximum number of frames recorded.

5. End Frame

Click or tap the input field of "End Frame" in *Figure 20.2* to set the end frame for playing back the waveforms. The default is the number of frames of the recorded waveforms.

21 Display Control

In the **Display** setting menu, you can set the type, persistence time, waveform intensity, grid type, grid brightness, and etc.

- Click or tap the function navigation icon  at the lower-left corner of the screen, and then select **Display** to enter the "Display" menu.
- Tap the **Display** icon on the small screen at the right side of the screen to enter the "Display" menu.

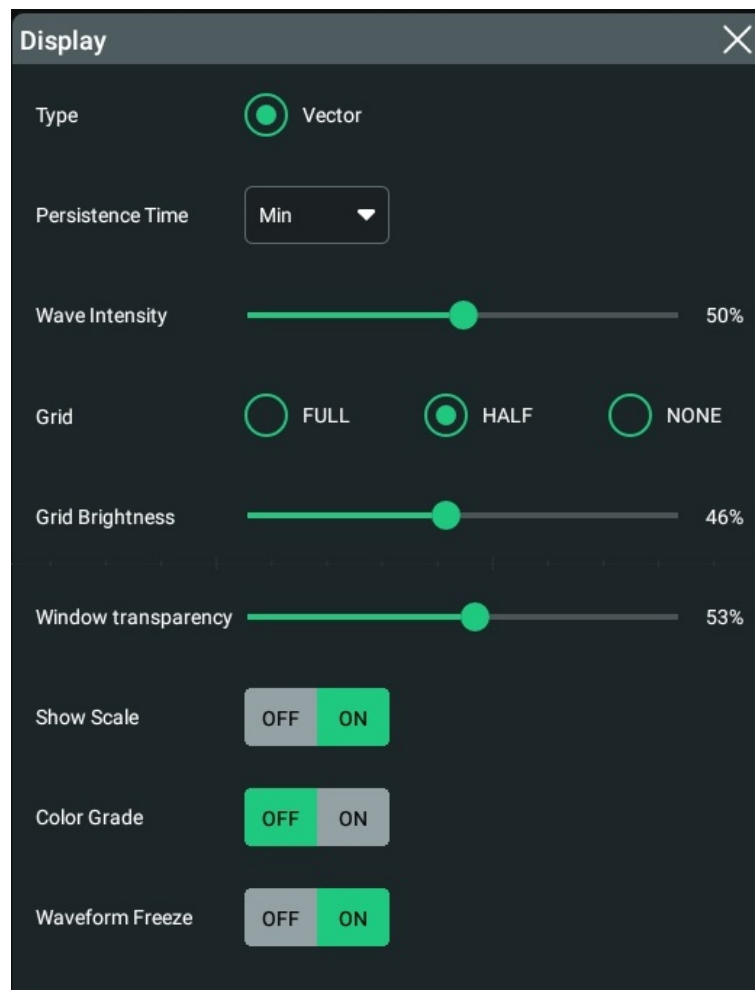

Figure 21.1 Display Setting Menu

21.1 Display Type

In the **Display** setting menu, click or tap "Vector" under **Type** to select the waveform display mode.

For the Vector type, the sample points are connected by lines and displayed. In most cases, this mode can provide the most vivid waveform for you to view the steep edge of the waveform (such as square waveform).

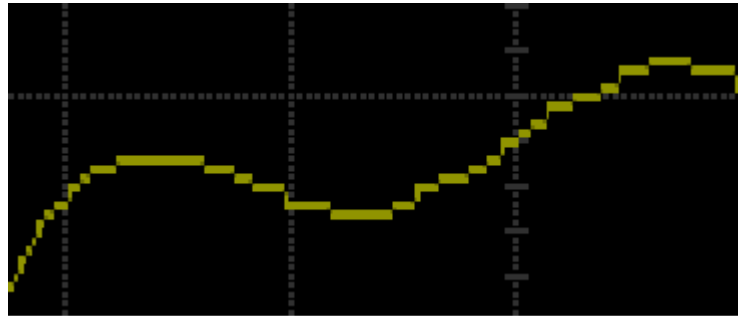

Figure 21.2 Vector Display

21.2 Persistence Time

In the **Display** setting menu, click or tap the drop-down button of **Persistence Time** to select the persistence time from the drop-down list. The available values are Min, specific values (i.g. 100 ms, 200 ms, 500 ms, 1 s, 2 s, 5 s, 10 s), and Infinite.

In the following part, a frequency sweep signal of the sine waveform is used to show the waveform effects in different persistence times.

- **Min**

Enables you to view waveform changing in high refresh rate.

- **Specific Values**

Enables to view glitches that change relatively slowly or glitches with lower occurrence probability. The persistence time can be set to 100 ms, 200 ms, 500 ms, 1 s, 2 s, 5 s, or 10 s.

- **Infinite**

In this mode, the oscilloscope displays the waveform newly acquired without clearing the waveforms acquired formerly. The waveforms acquired formerly will be displayed in relatively low-brightness color and the newly acquired waveforms will be displayed in normal brightness and color. Infinite persistence can be used to measure noise and jitter and to capture incidental events.

21.3 Intensity

In the **Display** setting menu, drag the slide bar of **Wave Intensity** to set the waveform intensity. The default is 50%, and the range available is from 1% to 100%.

21.4 To Set the Screen Grid

In the **Display** setting menu, click or tap "FULL", "HALF", or "NONE" for the **Grid** menu.

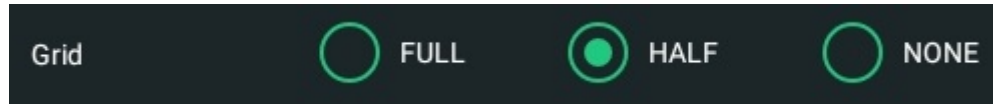

- **FULL:** turns the background grid and coordinate on.
- **HALF:** turns the background grid off.
- **NONE:** turns the background grid and coordinate off.

21.5 Display Setting

Grid Brightness

In the **Display** setting menu, drag the slide bar of **Grid Brightness** to set the grid brightness. The default is 50%, and the range available is from 1% to 100%.

Window Transparency

In the **Display** setting menu, drag the slide bar of **Window transparency** to set the window transparency. The default is 50%, and the range available is from 0% to 100%.

21.6 Show Scale

In the **Display** setting menu, click or tap the ON/OFF tab for the **Show Scale** menu to enable or disable scale display on the screen. By default, it is ON.

21.7 Color Grade

In the **Display** setting menu, click or tap the ON/OFF tab for the **Color Grade** menu to enable or disable the color grade display of the analog channel waveforms on the screen. By default, it is OFF.

When enabled, different colors are displayed on the screen to indicate the times of data acquisition or acquisition probability.

21.8 Waveform Freeze

In the **Display** setting menu, click or tap the ON/OFF tab for the **Waveform Freeze** menu to enable or disable the waveform freeze function. By default, it is ON.

When enabled, the oscilloscope displays the waveform after multiple sampling and superposition when sampling is stopped by clicking or tapping the **STOP/RUN** icon at the top of the screen. If disabled, the last triggered waveform is displayed.

22 Storage

You can save the current setups, waveforms, screen image, and parameters of the oscilloscope to the internal memory or external USB storage device (such as USB storage device) in various formats and load the stored setups or waveforms when needed. Also you can load the upgrade software to the system and perform the upgrade operation for the instrument.

You can also copy, delete, or rename the specified type of file from the internal memory or external USB storage device via the disk management menu.

This oscilloscope provides two USB HOST interfaces on the front panel and two USB HOST interfaces on the rear panel, which can all be connected to the USB storage device for external storage. The USB storage devices connected are marked as "Removable USB Disk (D)", "Removable USB Disk (E)", "Removable USB Disk (F)", "Removable USB Disk (G)", and etc.



TIP

This oscilloscope only supports the flash memory USB storage device of FAT32 format.

22.1 To Enter the Storage Menu

To enter the storage setting menu, perform the following operations:

- Click or tap the function navigation icon  at the lower-left corner corner of the screen, and then select **Storage** to enter the storage setting menu.
- Tap the **Storage** icon on the small screen to enter the storage setting menu.
- Click or tap the **Storage** icon in the quick operation bar of the large screen to enter the storage setting menu.

In the **Storage** setting menu, there are three sub-menus (Save, Load, and Upgrade) for you to choose. Click or tap to enter the specified sub-menu and configure the corresponding parameters.

22.2 To Save a File

In the **Storage** menu, click or tap the **Save** tab to enter the save setting menu. In this menu, you can save the image, waveform or setup files.

22.2.1 Save Image

In the **Storage** menu, click or tap the **Save** tab to enter the save operation menu. In this menu, click or tap the drop-down button of **Choose** to select "**Save Image**" to

enter the "Save Image" setting menu. Set the relevant parameters and save the image to the internal or external memory.

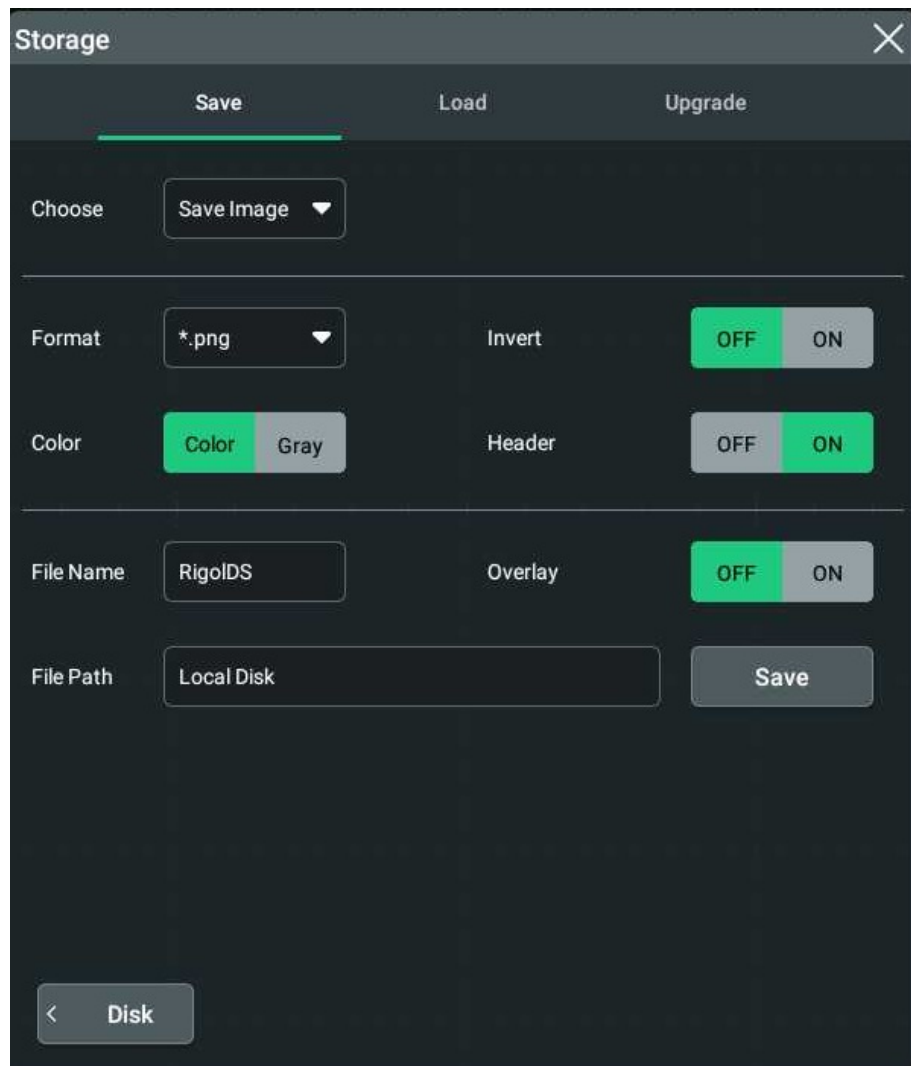

Figure 22.1 Image Saving Setting Menu

Set the image format

- **Format:**

Click or tap the drop-down button of **Format** to select **"*.png"**, **"*.bmp"**, or **"*.jpg"** from the drop-down list. Then the screen image will be saved to the internal or external memory in ".png", ".bmp", or ".jpg" format.

- **Invert:**

Click or tap the ON/OFF button for the **Invert** menu to enable or disable the image invert function.

- **Color:**

Click or tap **"Color"** or **"Gray"** for **Color** to select the desired storage color.

- **Header:**

Click or tap the ON/OFF tab for the **Header** menu to enable or disable the display of the header. If you select "ON", the instrument model and the image creation date will be displayed in the header of the image when you save the image file.

Set the file saving parameters

- **Set the filename**

Click or tap the input field of **File Name** to input the file name to be saved with the pop-up virtual keypad.

- **Set the file path**

Click or tap the input field of **File Path**, then the disk management interface is displayed. You can click or tap the saved file to view the saved image file. For detailed operations, refer to descriptions in *Disk Management*.

- **Overlay**

Click or tap the ON/OFF button for the **Overlay** menu to enable or disable the overwriting function. When enabled, the existing file in the specified file path will be overwritten by the newly saved file that has the same filename as the existing one.

After a USB storage device (FAT32, Flash type) is connected, press  on the front panel to make a quick save. If no external USB device is found to be connected to instrument, the file is saved to the internal memory by default. If an external USB device is connected, the file is saved to the USB device by default.

22.2.2 Save Wave

In the **Storage** menu, click or tap the **Save** tab to enter the save operation menu. In this menu, click or tap the drop-down button of **Choose** to select "**Save Wave**" to enter the "Save Wave" setting menu. The main setting information (e.g. "On/Off" state of the channel, vertical scale, and horizontal time base) and waveform data of all enabled channel will be save to the internal or external memory.

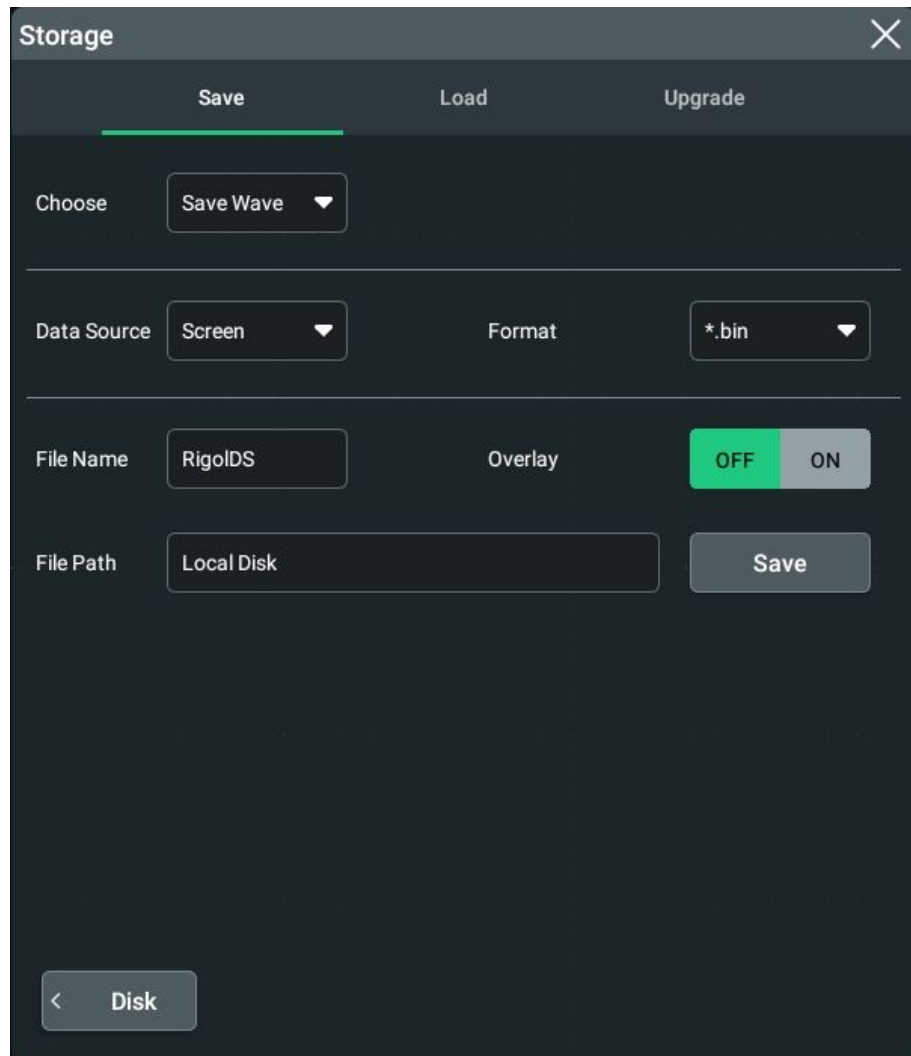

Figure 22.2 Waveform Saving Setting Menu

Set the Source of the Waveform Data and the Format of the Saved Waveform

- **Data Source**

Click or tap the drop-down button of **Data Source** to select "Screen" or "Memory" from the drop-down list.

- **Waveform Format**

Click or tap the drop-down button of **Format** to select "*.bin" or "*.csv" as the format of the saved waveform.

Set the file saving parameters

- **Set the filename**

Click or tap the input field of **File Name** to input the file name to be saved with the pop-up virtual keypad.

- **Set the file path**

Click or tap the input field of **File Path**, then the disk management interface is displayed. You can click or tap the saved file to view the saved image file. For detailed operations, refer to descriptions in *Disk Management*.

- **Overlay**

Click or tap the ON/OFF button for the **Overlay** menu to enable or disable the overwriting function. When enabled, the existing file in the specified file path will be overwritten by the newly saved file that has the same filename as the existing one.

After a USB storage device (FAT32, Flash type) is connected, press  on the front panel to make a quick save. If no external USB device is found to be connected to instrument, the file is saved to the internal memory by default. If an external USB device is connected, the file is saved to the USB device by default.

22.2.3 Save Setup

In the **Storage** menu, click or tap the **Save** tab to enter the save operation menu. In this menu, click or tap the drop-down button of **Choose** to select "**Save Setup**" to enter the "Save Setup" setting menu. Save the settings of the oscilloscope to the internal or external memory in "*.stp" format. When loading, the stored settings can be recalled.

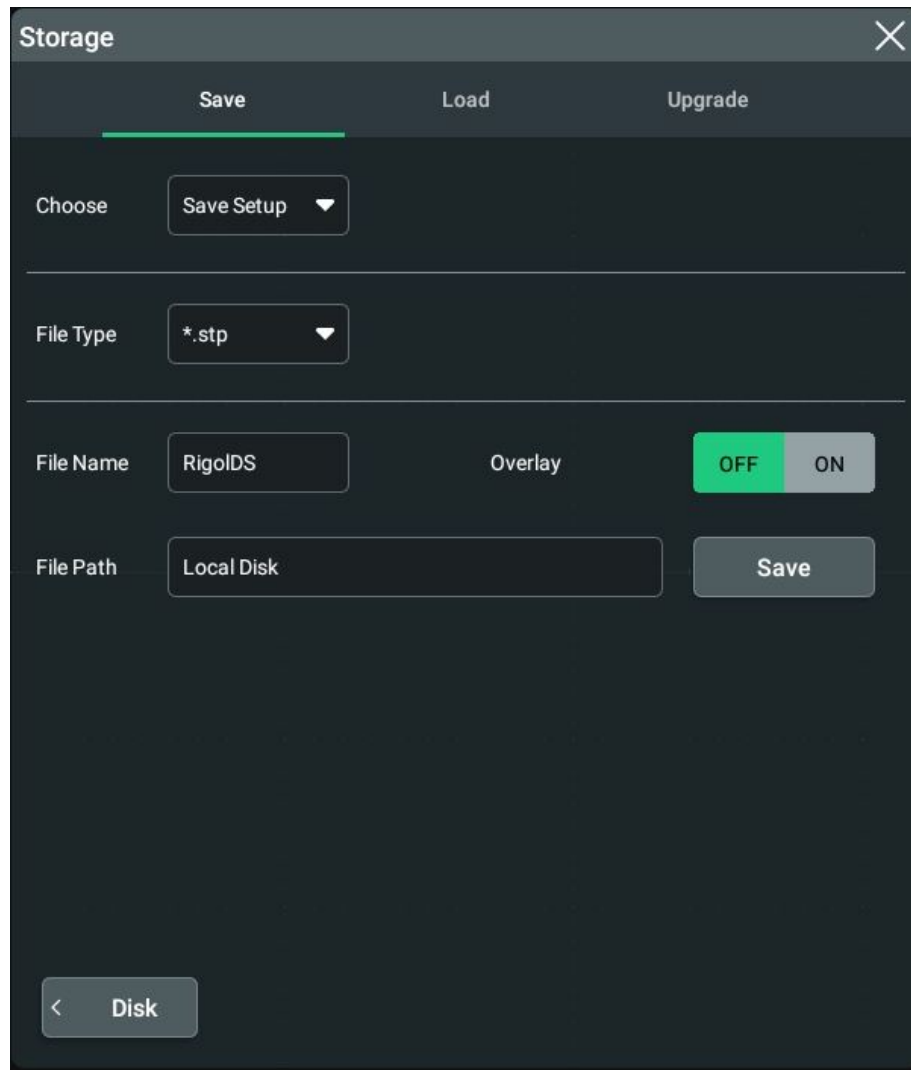

Figure 22.3 Setup Saving Setting Menu

Set the file saving parameters

- **Set the filename**

Click or tap the input field of **File Name** to input the file name to be saved with the pop-up virtual keypad.

- **Set the file path**

Click or tap the input field of **File Path**, then the disk management interface is displayed. You can click or tap the saved file to view the saved image file. For detailed operations, refer to descriptions in *Disk Management*.

- **Overlay**

Click or tap the ON/OFF button for the **Overlay** menu to enable or disable the overwriting function. When enabled, the existing file in the specified file path will

be overwritten by the newly saved file that has the same filename as the existing one.

After a USB storage device (FAT32, Flash type) is connected, press  on the front panel to make a quick save. If no external USB device is found to be connected to instrument, the file is saved to the internal memory by default. If an external USB device is connected, the file is saved to the USB device by default.

22.2.4 Binary Data Format (.bin)

Binary data format stores waveform data in binary format and provides data headers that describe these data. As data are displayed in binary format, its file size is much more smaller than that in ASCII format. If several channels are enabled, then all the displayed channels will be saved (save the first channel then save the second, and then it goes on like this until all the displayed channels are saved).

Table 22.1 BIN File Format

File Header	Waveform Header	Waveform Data Header	Channel Data	Waveform Header	Waveform Data Header	Channel Data
12 Bytes	128 Bytes	12 Bytes	n Bytes	128 Bytes	12 Bytes	n Bytes

In BIN file format, it contains the following channel data:

- CH1 Data
- CH2 Data
- CH3 Data
- CH4 Data
- Math Waveform Data

Binary Header Format

1. File Header

There is only one file header in a binary file. The file header contains the following information.

Table 22.2 File Header

Cookie	Two-byte characters, RG, indicating that the file is the RIGOL binary data file format.
Version	Two-byte, indicating the file version.

File Size	A 4-byte integer, indicating the number of bytes in the file. It includes the header.
Number of Waveforms	A 4-byte integer, indicating the number of waveforms that are stored in the file.

2. Waveform Header

It is possible to store several waveforms in the file. Each stored waveform has a waveform header. When several channels are stored, each channel can be considered as a separate waveform. The waveform header contains the information about the type of waveform data that are stored following the waveform data header.

Table 22.3 Waveform Header

Header Size	A 4-byte integer, indicating the number of bytes in the header.
Waveform Type	A 4-byte integer, indicating the type of the waveform stored in the file. 0 = Unknown 1 = Normal 2 = Peak Detection 3 = Average 4 = Not Used 5 = Not Used 6 = Logic
Number of Waveform Buffers	A 4-byte integer, indicating the number of waveform buffers required to read the data.
Number of Points	A 4-byte integer, indicating the number of waveform points in the data.
Count	A 4-byte integer, indicating the number of hits at each time interval during waveform recording when using a certain sample mode (e.g. Average) to create the waveforms. For example, when averaging, a count of 4 indicates that each waveform data point in the waveform recording has been averaged at least 4 times. The default value is 0.
X Display Range	A 4-byte float, indicating the X-axis duration of the waveform that is displayed. For time-domain waveforms, it indicates the

	duration of time across the display. If the value is zero, then no data has been acquired.
X Display Origin	An 8-byte double, indicating the X-axis value at the left edge of the screen. For time-domain waveforms, it indicates the time at the start of the display. The value is treated as a double precision 64-bit float point number. If the value is zero, then no data has been acquired.
X Increment	An 8-byte double, indicating the duration between data points on the X axis. For time-domain waveforms, it indicates the time between points. If the value is zero, then no data has been acquired.
X Origin	An 8-byte double, indicating the X-axis value of the first data point in the data recording. For time-domain waveforms, it indicates the time of the first point. The value is treated as a double precision 64-bit float point number. If the value is zero, then no data has been acquired.
X Units	<ul style="list-style-type: none"> - A 4-byte integer, indicating the unit of measurement for X values in the acquired data. - 0 = Unknown - 1 = Volts (V) - 2 = Seconds (s) - 3 = Constant - 4 Amps (A) - 5 = dB - 6 = Hz
Y Units	A 4-byte integer, indicating the unit of measurement for Y values in the acquired data. The possible values are listed above under X Units.
Date	A 16-byte character array, not used
Time	A 16-byte character array, not used
Frame	A 24-byte character array, indicating the model number and serial number of the oscilloscope in the format: MODEL#:SERIAL#.
Waveform Label	A 16-byte character array that contains the label assigned to the waveform.

3. Waveform Data Header

A waveform may have multiple data sets. Each waveform data set has a waveform data header. The waveform data header consists of information about the waveform data set. The header is stored before the data set.

Table 22.4 Waveform Data Header

Header Size	A 4-byte integer, indicating the number of bytes in the waveform data header.
Buffer Type	<ul style="list-style-type: none"> - A 2-byte integer, indicating the type of the waveform data stored in the file. - 0 = Unknown - 1 = Normal 32-bit float data - 2 = Maximum float data - 3 = Minimum float data - 4 = Not Used - 5 = Not Used - 6 = Digital unsigned 8-bit character data (for digital channels)
Bytes Per Point	A 2-byte short integer, indicating the number of bytes per data point.
Buffer Size	A 4-byte integer, indicating the size of the buffer required to hold the data points.

22.3 Load a File

In the storage setting menu, click or tap the **Load** tab to switch to the load menu. In this menu, you can load the local file to the instrument.

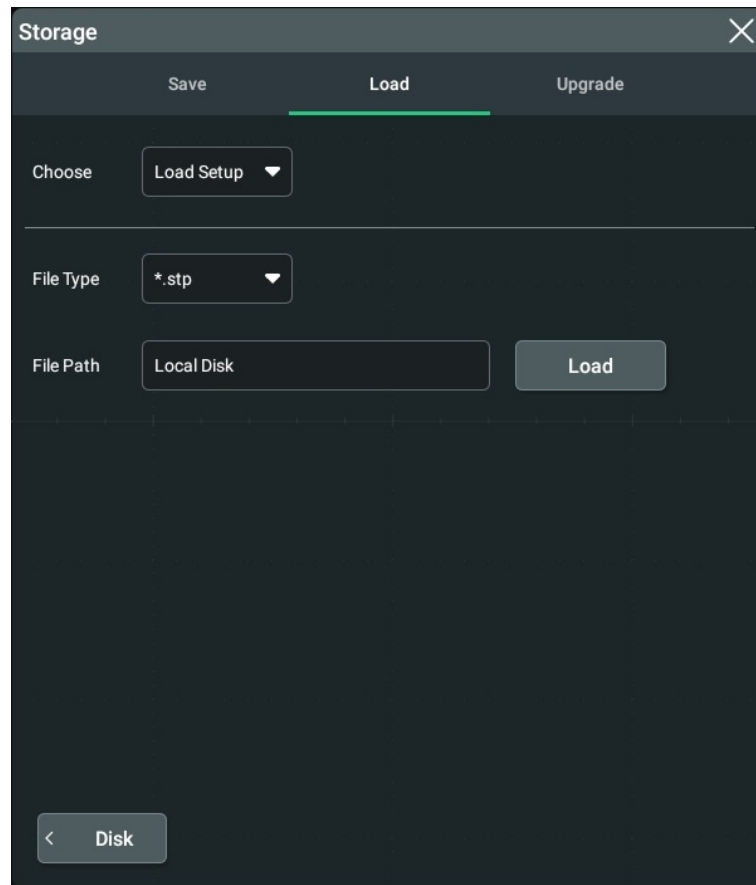

Figure 22.4 Load Setting Menu

Load Setup

Click or tap the drop-down button of **Choose** to select "Load Setup". Then, click or tap **File Path** to load the setups from the internal memory or the external USB disk. The default file type is "*.stp", and no other options are available. Select the file to be loaded from the memory. Click or tap **Load** to load the selected file.

22.4 System Upgrade

This instrument supports local upgrade and online upgrade.

Local upgrade

1. In the storage setting menu, click or tap **Upgrade** to enter the local upgrade setting menu.

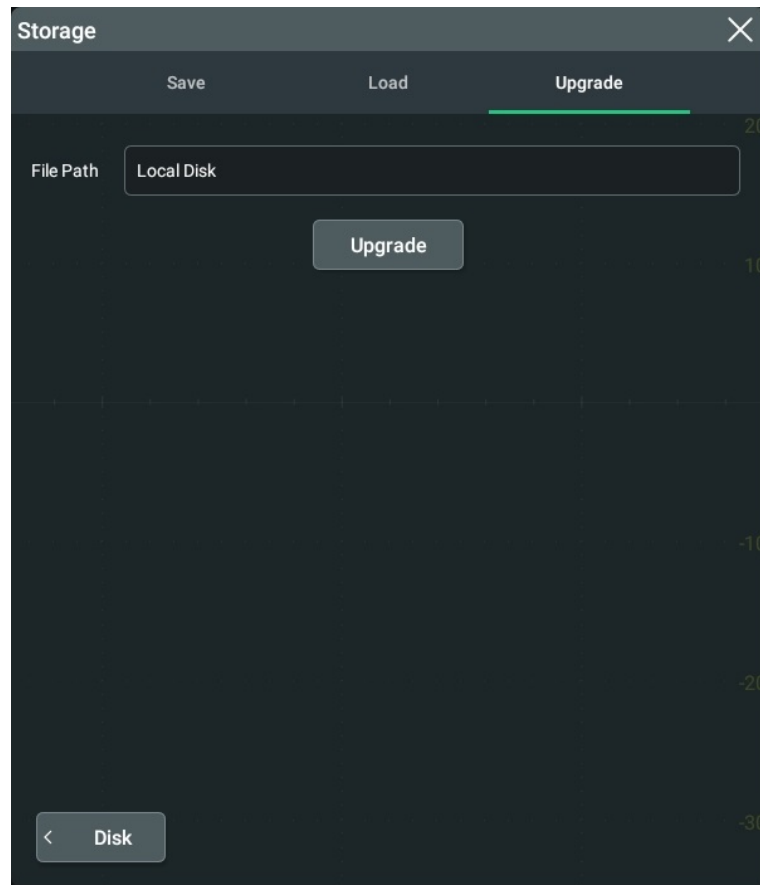



Figure 22.5 Upgrade Menu

2. Click or tap the input field of **File Path**, then the disk management interface is displayed. Select the upgrade file. For detailed operations, refer to the descriptions in *Disk Management*.
3. Click or tap **Upgrade** to complete the local upgrade.

Online upgrade

1. First ensure that the rear-panel LAN interface is connected to the network (if you do not have the access to the Internet, please ask the administrator to open the specified network authority).
2. Click or tap the function navigation icon  at the lower-left corner of the screen to enter the function navigation.
3. Then click or tap the **Upgrade** icon to perform the upgrade operation.

22.5 Disk Management

To enter the storage setting menu, perform the following operations:

- Click or tap the function navigation icon  at the lower-left corner corner of the screen, and then select **Storage** to enter the storage setting menu.
- Tap the **Storage** icon on the small screen at the right side of enter the storage setting menu.
- Click or tap the **Storage** icon at the top of the screen to enter the storage setting menu.

Then click or tap **Disk** at the lower-left corner of the "Storage" menu to enter the disk management interface, as shown in the figure below.

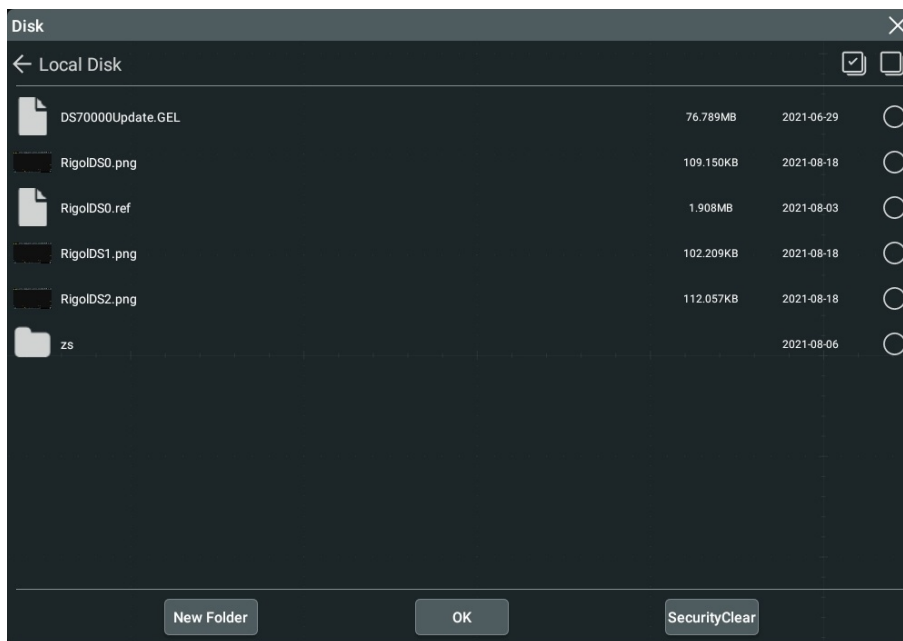

Figure 22.6 Disk Management Interface

Execute the following operations through the disk management menu:

Select a Disk

Before using the external storage device, make sure that a USB storage device (FAT32 format, flash memory) is connected correctly.

By default, the "Local Disk(C)" is selected. If an external storage device is inserted, under the "Disk" menu, two available storage disks can be selected at the upper-left corner of the "Disk" interface: Local Disk (C) and Removable USB Disk (D). If you select an external storage device, for example, if you select "Removable USB Disk (D)", the contents in USB Disk(D) will be displayed.

Create a Folder

Click or tap **New Folder**, then a folder name input keyboard is displayed.



For the methods of using the keypad, refer to descriptions in *Parameter Setting Method*. Click or tap any place on the screen to exit the keyboard.



Clear the Internal Memory Safely

Click or tap **SecurityClear**, then a prompt message "Execute secure memory wipe?" is displayed. Click or tap **OK** to clear all the files stored in the internal disk. Click or tap **Cancel** to cancel security clear operation.

Select a File

Before operating on the file or folder, first select the desired file or folder.

Click or tap the check box at the right side of the folder, if checked, it is selected, with an icon  being displayed. Click/tap the check box again or click/tap  to deselect it. The check box restores its original state.

DS70000 supports selecting multiple files or folders to operate on. You can also click or tap the icon  at the upper-right corner of the interface to select all the files and folders under the current disk. Click or tap  to cancel the select-all operation.

Cut, Copy, or Paste a File or a Folder

- **Cut a File to a Specified Folder**

Select a specified file or folder. Click or tap **Cut** to cut the specified file or folder. Then select the destination folder. Then click or tap **Paste** to paste the specified file or folder to the destination folder.

- **Copy a File to a Specified Folder**

Select a specified file or folder. Click or tap **Copy** to copy the specified file or folder. Then select the destination folder. Then click or tap **Paste** to paste the specified file or folder to the destination folder.

Delete a File or Folder

In the current folder, select the file or folder to be deleted. Click or tap **Delete**, then a prompt message "Are you sure to delete the file" is displayed. Click or tap **OK** to delete the file. Click or tap **Cancel** to cancel the deletion operation.

Rename a File or Folder

Select a specified file or folder, then click or tap **Rename** to input a new filename or folder name with the pop-up numeric keypad. Then, the rename operation is completed.

22.6 Factory Settings

Press  on the front panel or click/tap the **Default** icon at the top of the screen, then a prompt message "Restore default settings?" is displayed. Click or tap



OK to restore the instrument to its factory default settings, as shown in the table below.

Table 22.5 Factory Settings

Parameter	Factory Settings
Horizontal	
Horizontal Scale	5 ns
Horizontal Position	0 s
Delayed Sweep	OFF
Roll	Auto
Fine	OFF
Horizontal Expansion	Center
Memory Depth	10 Kpts
Vertical	
VScale	100 mV
VOffset	0 V
CH1	ON
CH2	OFF
CH3	OFF
CH4	OFF
Channel Coupling	DC
BW Limit	OFF
Attenuation	1X
Impedance	1 MΩ
Invert	OFF
Fine	OFF
Channel Unit	[V]
Display Label	OFF
Channel Delay	0 s
Bias	0 V
Acquire	
Acquisition Mode	Normal
Memory Depth	Auto
Anti-Aliasing	OFF
Trigger	
Trigger Type	Edge Trigger
Source Selection	CH1
Edge Type	Rising
Trigger Mode	Auto

Parameter	Factory Settings
Trigger Coupling	DC
Trigger Holdoff	8 ns
Noise Rejection	OFF
Display	
Display Type	Vector
Persistence Time	Min
Intensity	50%
Grid	FULL
Grid Brightness	50%
Window Transparency	50%
Show Scale	ON
Color Grade	OFF
Waveform Freeze	ON
Measure	
Mode	Normal
Indicator	OFF
Statistics	OFF
Count	1,000
Threshold Type	%
Threshold Source	CH1
Upper Threshold	90%
Mid Threshold	50%
Lower Threshold	10%
Amplitude Measurement Method	Auto
Region	Main
Save Image	
Overlay	OFF
Header	ON
Format	*.png
Invert	OFF
Color	Color
Save Wave	
Data Source	Screen
Format	*.bin
Save Setup	
File Type	*.stp
Load Setup	
File Type	*.stp

Parameter	Factory Settings
System Setting	
Load last	Default
Beeper	OFF
AUX Out	TrigOut
Vibration	ON
Screen Lock	OFF
Expand	GND
Show Time	ON
Other Setting	
Backlight of the Electronic Tag	OFF
EXT 10M IN	OFF
Auto Config	
Peak to Peak	ON
Live CH	OFF
Overlay	ON
Coupling	OFF
Quick Settings	
Operation	Save Image
Format	*.png
Invert	OFF
Color	Color
Pass/Fail Test	
Enable	OFF
Source	CH1
X Mask	240 mdiv
Y Mask	480 mdiv
Format	*.pf
Format	*.pf
File Name	RigolDS
Aux Output	OFF
Output Event	Fail
Polarity	Positive
Pulse	1 μ s
Error Action	N/A
Waveform Recording	
Waveform Recording	OFF
Record	

Parameter	Factory Settings
Interval	10 ns
Frames	1,000
Beeper	
Play	
Mode	
Sequence	
Interval	100 ms
Math Operation	
Invert	OFF
Expand	GND
Display Label	OFF
Grid	FULL
A+B	
Operation	OFF
SourceA	CH1
SourceB	CH1
Offset	0 V
Scale	500 mV
A-B	
Operation	OFF
SourceA	CH1
SourceB	CH1
Offset	0 V
Scale	500 mV
A×B	
Operation	OFF
SourceA	CH1
SourceB	CH1
Offset	0 U
Scale	500 mU
A÷B	
Operation	OFF
SourceA	CH1
SourceB	CH1
Offset	0 U
Scale	500 mU
FFT	
Operation	OFF
Source	CH1
Offset	0 dBV

Parameter	Factory Settings
VScale	20 dBV
Unit	dBm/dBV
X	Start-End
Start Freq	0 Hz
Stop Freq	10 MHz
Window Function	Hanning
Color Grade	OFF
Peak Search	OFF
Peak Number	5
Threshold	5.5 dBV
Excursion	1.8 dBV
Table Order	Amp Order
A&&B	
Operation	OFF
SourceA	CH1
SourceB	CH1
Wave Size	Medium
Thre.CH1	0 V
Thre.CH2	0 V
Thre.CH3	0 V
Thre.CH4	0 V
Sensitivity	300 mdiv
Offset	0 div
A B	
Operation	OFF
SourceA	CH1
SourceB	CH1
Wave Size	Medium
Thre.CH1	0 V
Thre.CH2	0 V
Thre.CH3	0 V
Thre.CH4	0 V
Sensitivity	300 mdiv
Offset	0 div
A^B	
Operation	OFF
SourceA	CH1
SourceB	CH1
Wave Size	Medium
Thre.CH1	0 V
Thre.CH2	0 V

Parameter	Factory Settings
Thre.CH3	0 V
Thre.CH4	0 V
Sensitivity	300 mdiv
Offset	0 div
!A	
Operation	OFF
SourceA	CH1
Wave Size	Medium
Thre.CH1	0 V
Thre.CH2	0 V
Thre.CH3	0 V
Thre.CH4	0 V
Sensitivity	300 mdiv
Offset	0 div
Intg	
Operation	OFF
Source	CH1
Scale	500 mV*s
Offset	0 V*s
Bias	0
Diff	
Operation	OFF
Source	CH1
Scale	500 mV/s
Offset	0 V/s
Smooth	5
Sqrt	
Operation	OFF
Source	CH1
Scale	500 mU
Offset	0 U
Lg	
Operation	OFF
Source	CH1
Scale	500 mU
Offset	0 U
Ln	
Operation	OFF
Source	CH1
Scale	500 mU
Offset	0 U

Parameter	Factory Settings
Exp	
Operation	OFF
Source	CH1
Scale	500 mU
Offset	0 U
Abs	
Operation	OFF
Source	CH1
Scale	500 mV
Offset	0 V
Low Pass	
Operation	OFF
Source	CH1
Scale	500 mV
Offset	0 V
ωc	20 MHz
High Pass	
Operation	OFF
Source	CH1
Scale	500 mV
Offset	0 V
ωc	20 MHz
Band Pass	
Operation	OFF
Source	CH1
Scale	500 mV
Offset	0 V
$\omega c1$	20 MHz
$\omega c2$	40 MHz
Band Stop	
Operation	OFF
Source	CH1
Scale	500 mV
Offset	0 V
$\omega c1$	20 MHz
$\omega c2$	40 MHz
AX+B	
Operation	OFF
Source	CH1
Scale	500 mV
Offset	0 V

Parameter	Factory Settings
A	1
B	0
Ref	
Current	Ref1
Source	CH1
VScale	1 V
VOffset	0 V
Label	REF1
Label Display	OFF
Color	Orange

23 System Utility Function Setting

In the **Utility** menu, you can set the I/O parameters and the system-related function parameters. To enter the "Utility" menu, perform the following operations.

- Click or tap the Notification Area at the lower-right corner of the screen. Then the **Utility** menu is displayed.
- Click or tap the function navigation icon  at the lower-left corner of the screen, then select **Utility** to enter the **Utility** menu.
- Tap the **Utility** icon on the small screen at the right side of the screen to enter the **Utility** menu.

23.1 I/O Setting

In **Utility** menu, click or tap **IO** to enter the I/O setting menu to configure the following parameters.

Network Status

Different prompts will be displayed according to the current network connection status.

- Network Config Succeeded!
- Acquiring IP...
- IP Conflict!
- DISCONNECTED!
- DHCP Config Failed
- Read Status Fail!
- CONNECTED
- Invalid IP
- IP lost
- Please wait...

MAC Address

For each instrument, the MAC address is unique. When assigning the IP address for the instrument, the system uses the MAC address to identify the instrument.

VISA Address

Displays the VISA address currently used by the instrument.

IP Configuration Type

The configuration type of the IP address can be DHCP, Auto IP, or Static IP. In different IP configuration types, the configurations for IP address and other network parameters are different.

- **DHCP**

If "DHCP" is selected, the DHCP server in the current network will assign the network parameters (e.g. IP address, Subnet, Gateway, and DNS) for the instrument.

- **Auto IP**

When "Auto IP" is selected, the instrument will acquire the IP address ranging from "169.254.0.1" to "169.254.255.254" and the subnet mask (255.255.0.0) automatically based on the current network configuration. The "Auto IP" works only when "DHCP" is not selected or connection is failed.

- **Static IP**

If "Static IP" is selected, the instrument is configured with static IP. In this case, you need to disable DHCP and Auto IP manually. Then you need to configure the parameters such as "IP address", "Subnet", "Gateway", and "DNS" manually. At this time, you can self-define the network parameters (e.g. IP address) of the instrument.

- **Set the IP address**

The format of the IP address is nnn.nnn.nnn.nnn. The range of the first segment (nnn) of the address is from 0 to 255 (except 127); wherein, the valid range is from 0 to 223. The range for the other three segments is from 0 to 255. You are recommended to ask your network administrator for an IP address available.

This setting will be saved to the non-volatile memory; if "Power On" is set to "Last", then DHCP and Auto IP are disabled at the next power-on. The instrument will load the preset IP address automatically.

- **Set the subnet mask**

The format of the subnet mask is nnn.nnn.nnn.nnn. Wherein, the range of "nnn" is from 0 to 255. You are recommended to ask your network administrator for a subnet mask available.

This setting will be saved in the non-volatile memory; if "Power On" is set to "Last", then DHCP and Auto IP are disabled at the next power-on. The instrument will load the preset subnet mask automatically.

- **Set the default gateway**

You can set this parameter in Static IP mode. The format of the gateway is nnn.nnn.nnn.nnn. The range of the first segment (nnn) is from 0 to 223 (except 127), and the range for the other three segments is from 0 to 255. You are recommended to ask your network administrator for a gate address available.

This setting will be saved in the non-volatile memory; if "Power On" is set to "Last", then DHCP and Auto IP are disabled at the next power-on. The instrument will load the preset gateway automatically.

- **Set the DNS address**

You can set this parameter in Static IP mode. The format of the DNS address is "nnn.nnn.nnn.nnn". The range for the first segment (nnn) of the address is from 0 to 223 (except 127); and the range for the other three segments is from 0 to 255. You are recommended to ask your network administrator for an address available.

Generally, you do not need to set the DNS, therefore this parameter setting can be ignored.



TIP

- When the three IP configuration types are all turned on, the priority of the parameter configuration from high to low is "DHCP", "Auto IP", and "Static IP".
- The three IP configuration types cannot be all turned off at the same time.

mDNS

Click or tap the ON/OFF tab for mDNS to enable or disable the multicast Domain Name System (mDNS). This system is used to provide the function of DNS server for service discovery in a small network without a DNS server.

Host Name

If mDNS is enabled, you need to configure the mDNS host name, supporting inputting a maximum of 26-byte strings.

GPIB

When using the GPIB interface, use the USB-GPIB interface converter(an option that requires to be ordered separately) to extend the GPIB interface, and then use the GPIB cable to connect the instrument to the PC. Configure the GPIB address. Its settable range is from 1 to 30. By default, it is 1.

Apply the Network Parameter Setting

Click or tap **Apply** to validate the current network parameter setting.

23.2 Basic Settings

In the **Utility** menu, click or tap **Setup** to enter the basic setting menu.

Language

This product supports menus in multiple languages. Both Chinese and English are available for the display of the help information, prompt messages, and interface. Click or tap the drop-down button of **Language** to select the specified system language from the drop-down list.

Load last

You can set the system configuration to be recalled when the oscilloscope is powered on again after power-off. Click or tap "Default" or "Last" for **Load last**.

- Last: returns to the setting of the system at last power-off.
- Default: returns to the factory setting of the system.

Power status

- Switch Off: After the oscilloscope is connected to power, you need to press the Power key on the front panel to power on the instrument.
- Switch On: After the the oscilloscope is connected to power, it will be powered on immediately.

Beeper

Click or tap the ON/OFF button for the **Beeper** menu item to enable/disable the beeper. When the beeper is enabled, you can hear the sound of the beeper when you perform the following operations:

- Press a key or a menu key on the front panel
- Enable the touch screen
- When a prompt message is displayed

AUX Out

You can set the type of the signal output from the **AUX OUT** connector on the rear panel.

- TrigOut: After this type is selected, at each trigger (hardware trigger), the oscilloscope outputs a signal from the **AUX OUT** connector on the rear panel that can reflect the current capture rate of the oscilloscope. If this signal is connected to a waveform display device to measure the frequency, the found measurement result is the same as the current capture rate.
- PassFail: When this type is selected, the instrument can output a positive or negative pulse via the **AUX OUT** connector when a successful or failed event is detected. Refer to descriptions in *To Set the Output Form of the Test Results*. When you enable the Aux output, the **AUX Out** menu is automatically set to

"PassFail". When the **AUX Out** menu is set to "TrigOut", then in the pass/fail test menu, the Aux Out function is automatically disabled.

Vibration

Sets whether to vibrate when you perform the touch-enabled operation on the small screen at the right side of the front panel.

Click or tap the ON/OFF button for the **Vibration** menu item to enable/disable the vibration.

Screen Lock

Sets whether to lock the front-panel keys and touch screen operation. Once the screen is locked, the touch screen function is disabled, you can no longer operate on the screen.

Click or tap the ON/OFF button for the **Screen Lock** menu item to enable or disable the screen operation. After the screen is locked, press the front-panel channel button CH1, CH3, CH2, and CH4 in sequence to unlock the screen.

Expand

Click/tap to select whether to expand or compress the waveform around the "Center" or "GND".

- **Center:** when the vertical scale is changed, the waveform will be expanded or compressed around the screen center.
- **GND:** when the vertical scale is changed, the waveform will be expanded or compressed around the signal ground level position.

Display Time

The system time (date and time) is displayed in the Notification Area at the lower-right corner of the screen. The date is displayed in "yyyy/mm/dd" format, and the time is displayed in "hh:mm:ss" format. When you save the waveform, the output file will contain the time information. Users can set the system time.

- **Date:** Click or tap the "Date" area, then the date setting interface is displayed. Select a proper date, then click or tap **OK** to confirm the date modification. Click or tap **Cancel** to cancel date modification and exit the date menu.
- **Time:** Click or tap the "Time" area, then the time setting interface is displayed.
 - Click or tap "AM" or "PM" at the left part of the interface to select an AM or PM time. The selected item is illuminated.
 - Click or tap the Hour/Minute number and then drag the hour/minute hand to modify the time.
 - After setting, click or tap **OK** to confirm the setting. Click or tap **Cancel** to cancel the time modification and exit the time menu.

23.3 About this Oscilloscope

In **Utility** menu, click or tap **About**, and then you can view the model, version, and other information about this instrument in **About** menu.

- **Model**
Indicates the product model.
- **Serial number**
Indicates the serial number of the product, the unique identification for the product.
- **Firmware**
Indicates the firmware version number of the product.
- **Hardware**
Indicates the hardware version number of the product.
- **Build**
Indicates the creation time of the software version.
- **Android.Build**
Indicates the creation time of the Android operating system.
- **Android.Version**
Indicates the version number of the Android operating system. For example, 7.1.0.
- **Launcher**
Indicates the desktop UI version number of the Android operating system.
- **WebControl**
Indicates the version number of browser remote control module.

23.4 Other Setting

EXT 10M IN

Indicates the rear-panel 10 MHz IN reference clock input interface. When ON, the interface is enabled; when OFF, the interface is disabled.

Electronic Tag

When you select ON, the backlight of the electronic tag at the upper-right corner of the front panel is illuminated; when you select OFF, the backlight turns off.

23.5 SelfCal

The self-calibration program can quickly make the oscilloscope to work in an optimal state to get the precise measurement results. You can perform self-calibration at any time, especially when the changes of the ambient temperature reach or exceed 5°C. Make sure that the oscilloscope has been warmed up or operating for more than 30 minutes before the self-calibration.

In "Utility" menu, click or tap **SelfCal**, the self-calibration menu is as shown below.

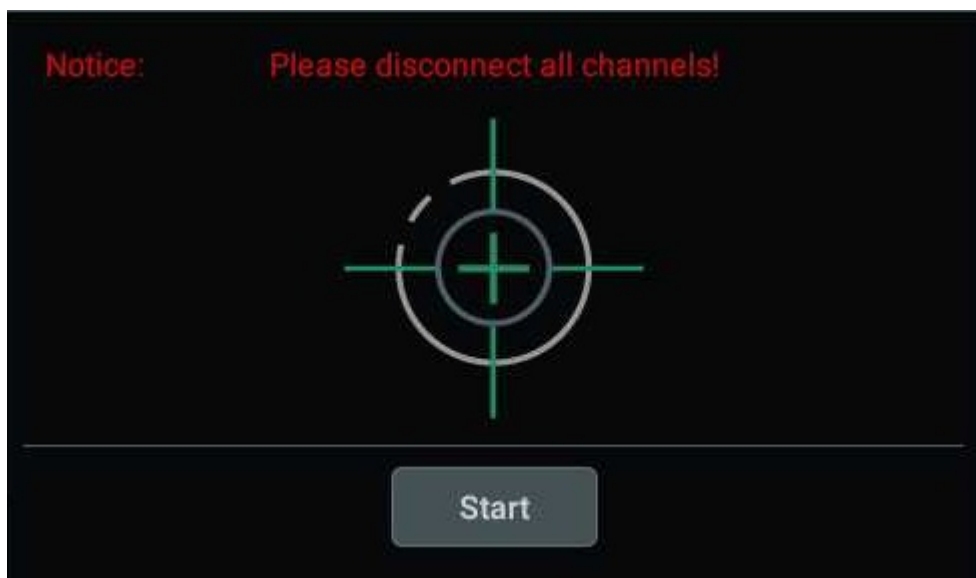

Figure 23.1 Self-calibration Menu

- Click or tap **Start**, and then the oscilloscope will start to execute the self-calibration program.
- After starting the self-calibration program, click or tap **Exit** to cancel self-calibration operation at any time.
- Click or tap **Close** to close the self-calibration information window.

23.6 Option List

In the "Utility" menu, click or tap **Option list**, then all the options that have currently been installed can be displayed. For the procedures of installing the options, refer to *To View the Option Information and the Option Installation*.

23.7 Quick Settings

In the **Utility** menu, click or tap **Quick Settings** to enter the quick setting operation menu.

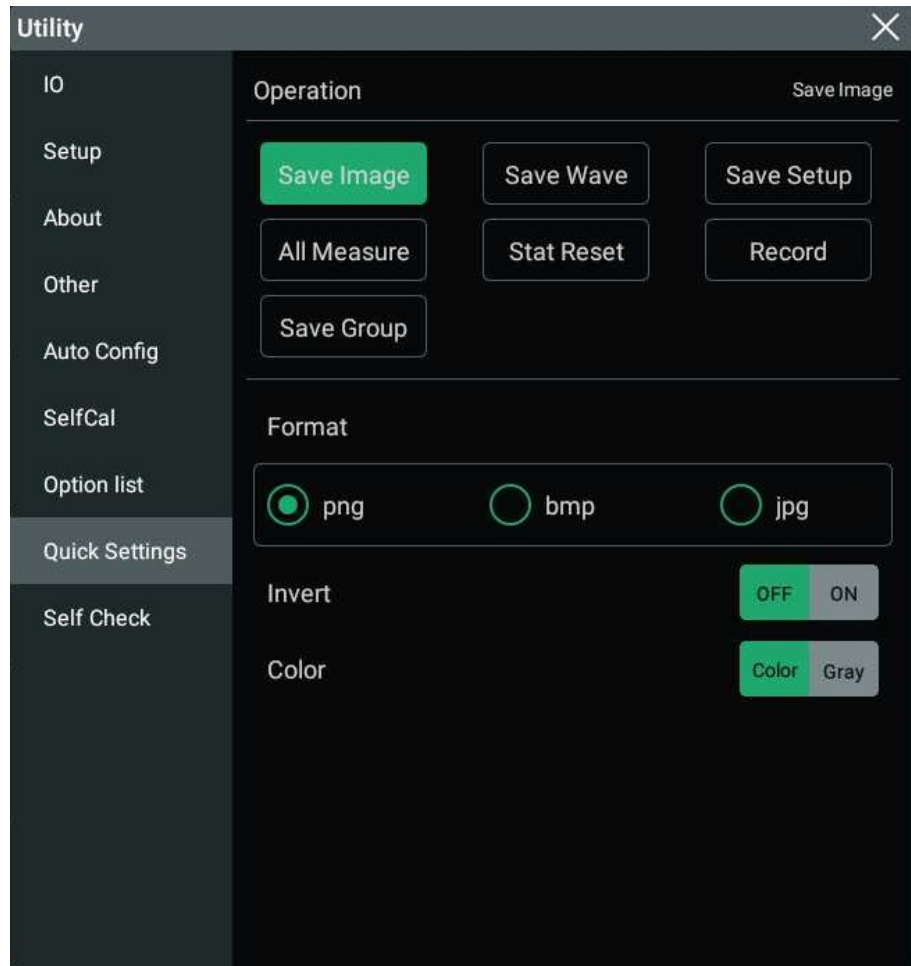

Figure 23.2 Quick Settings Menu

Save Image

- Click or tap **Save Image**, then **Operation** is set to "Save Image".
- In the **Format** menu item, the available image type can be **".*.png"**, **".*.bmp"**, or **".*.jpg"**.
- Click or tap the ON/OFF button for the **Invert** menu item to enable or disable the invert function.
- Click or tap **"Color"** or **"Gray"** for **Color** to select the desired storage color.

After setting, click or tap the button  at the upper-right corner of the instrument to capture the current screen and save the image with the specified

format. If a USB storage device is connected, by default, it is saved to the external memory, otherwise, it will be saved to the specified path in the internal memory.

Save Wave

- Click or tap **Save Wave**, then **Operation** is set to "Save Wave".
- Click or tap to select "Memory" or "Screen" under **Data Source** as the source of the saved waveform.
- The available choices under **Format** include "*.bin" and "*.csv".

After setting, click or tap the button  at the upper-right corner of the instrument to save the waveform based on the settings. If a USB storage device is connected, by default, it is saved to the external memory, otherwise, it will be saved to the specified path in the internal memory.

Save Setup

Click or tap **Save Setup**, then **Operation** is set to "Save Setup".

After setting, click or tap the button  at the upper-right corner of the instrument to save the setup file suffixed with "*.stp". If a USB storage device is connected, by default, it is saved to the external memory, otherwise, it will be saved to the specified path in the internal memory.

All Measurement

- Click or tap **All Measure**, then **Operation** is set to "All Measure".
- In **All Measure** menu item, click or tap the drop-down button to select the measurement channel (CH1-CH4).

After setting, click or tap the button  at the upper-right corner of the instrument to perform the measurement on the specified channel.

Reset Statistics

- Click or tap **Stat Reset**, then **Operation** is set to "Stat Reset".
- Under **Stat Reset**, click or tap "Measure" or "Pass/Fail" to reset the statistics of the specified function.

After setting, click or tap the button  at the upper-right corner of the instrument, then the statistics of the specified function under the **Result** list at the right side of the screen will be cleared and new measurement will be launched.

Waveform Recording

Click or tap **Record**, then **Operation** is set to "Record".

After setting, click or tap the button  at the upper-right corner of the instrument to perform the waveform recording.

Save Group

- Click or tap **Save Group**, then **Operation** is set to "Save Group".
- Under **Save Group**, select one or multiple items from "Save Image", "Save Wave", and "Save Setup".

After setting, click or tap the button  at the upper-right corner of the instrument to save the selected items based on the settings. If a USB storage device is connected, by default, it is saved to the external memory, otherwise, it will be saved to the specified path in the internal memory.

23.8 Self-check

In **Utility** menu, click or tap **Self Check** to enter the "Self Check" setting menu. You can test the following self-check items for the device.

Key Test

Click or tap **Key Test** to enter the key test interface (virtual front panel key), as shown in the figure below.

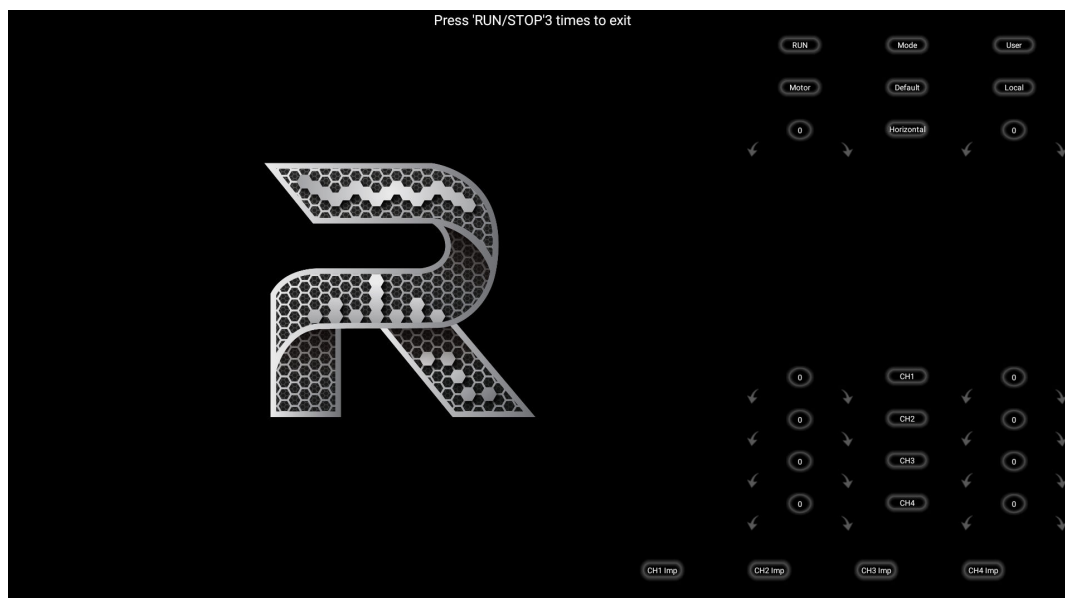

Figure 23.3 Key Test Interface

At this time, you can press the keys on the front panel to check whether the virtual keys are highlighted. If yes, it indicates that the keys work normally; if no, it indicates that there's something wrong with the keys. If the virtual key is not illuminated, the

key may fail to work. Press **RUN/STOP** for three consecutive times to exit the key test interface.

Touch Test

Click or tap **Touch Test** to enter the touch screen test interface, as shown in the figure below.

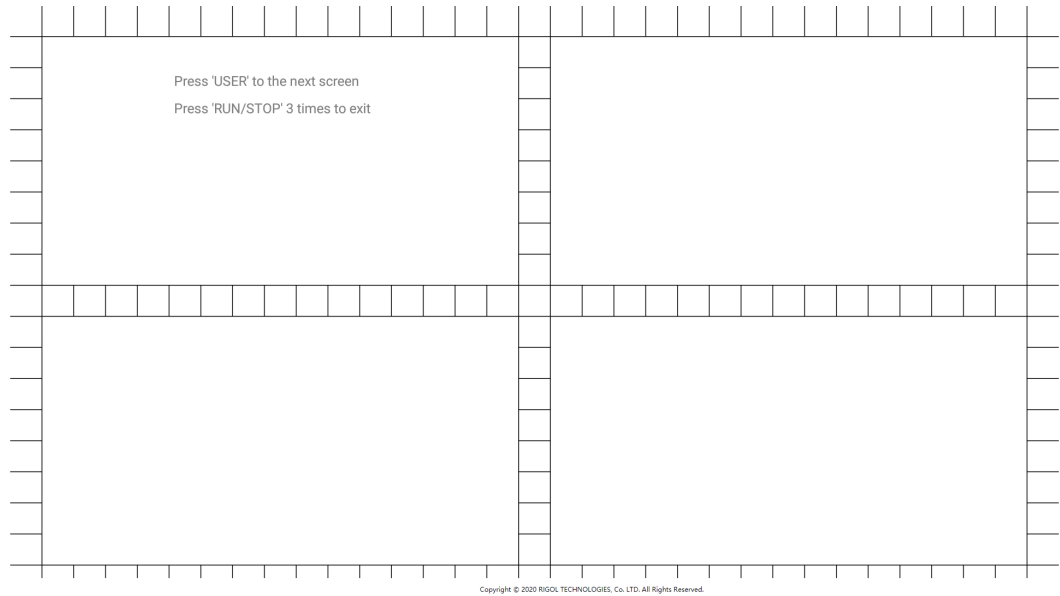

Figure 23.4 Touch Screen Test Interface

Slide with your finger on the screen. If there is a line displaying at the empty area where you slide on the screen and the box that you tap turns out to be filled with green background, it indicates that the touch function of this area is normal. Then press **USER** to switch to the next touch screen test interface, as shown in the figure below.

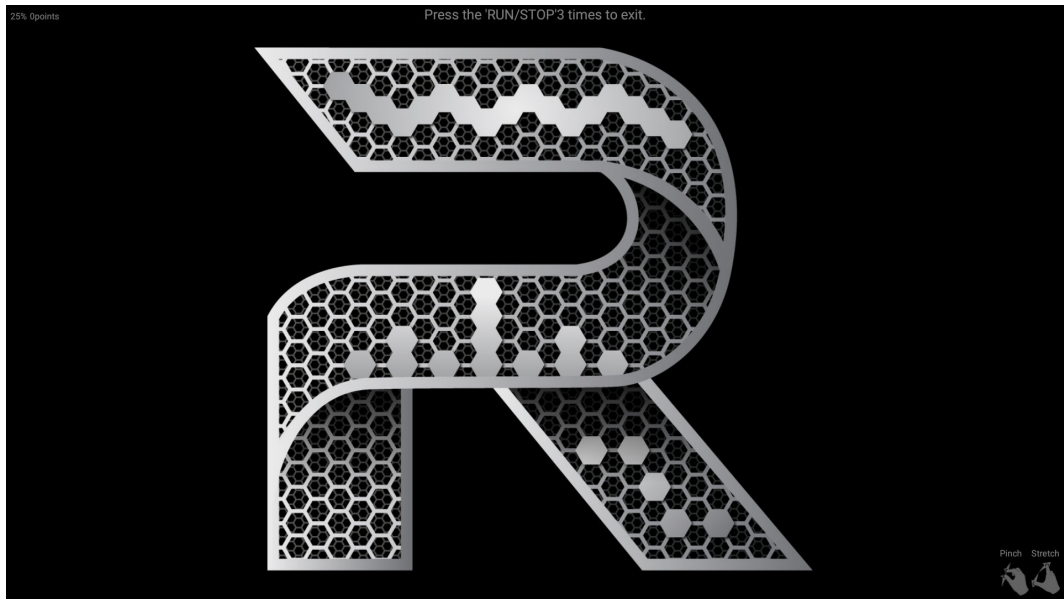

Figure 23.5 Touch-Enabled Gesture Operation Interface

At this time, you can pinch or stretch the icon **R** to zoom out or zoom in the icon to check whether the touch-enabled gestures work normally. Press **RUN/STOP** for three consecutive times to exit the touch screen test interface.

Screen Test

Click or tap **Screen Test** to enter the screen test interface and check whether the defective pixel exists.

There are 15 screen test interfaces. Press **USER** to switch to the next screen test interface. Press **RUN/STOP** for three consecutive times to exit the screen test interface.

Board Test

Click or tap **Board Test**, then the board test interface is displayed. Check whether the status of each module is in good condition.

Board Test							
Id	Item	Value	Range	Id	Item	Value	Range
0	Fan Speed	61	0~100	22	CH2_Probe	3.52V	24.2mV~3.6V
1	PCB HOTEST	70.4°	0°~80°	23	CH3_Probe	3.52V	24.2mV~3.6V
2	PCB FAN IN	51.6°	0°~80°	24	CH4_Probe	3.51V	24.2mV~3.6V
3	KUC_TEMP	35.9°	0°~100°	25	SW_LA	OFF	0~1
4	KUM1_TEMP	51°	0°~100°	26	SW_DDR	ON	0~1
5	KUS2_TEMP	52.2°	0°~100°	27	SW_PRE_PROC1	ON	0~1
6	ADC1_TEMP	67.8°	0°~112°	28	SW_PRE_PROC2	ON	0~1
7	ADC2_TEMP	64.6°	0°~112°	29	SW_FILTER2	ON	0~1
8	ADC3_TEMP	65.4°	0°~112°	30	SW_ADC_BER	OFF	0~1
9	ADC4_TEMP	69°	0°~112°	31	SW_FINE_TRIG	ON	0~1
10	12V_PWR_IN	11.8V	11V~13V	32	SW_LINEAR_INTP	ON	0~1
11	3.3V_SYS	3.35V	3.2V~3.4V	33	SW_SPU_COMPRES	ON	0~1
12	SPU1_INT_0V95	990mV	900mV~1.03V	34	SW_MASK	ON	0~1
13	SPU2_INT_0V95	990mV	900mV~1.03V	35	SW_ZONE_TRIG	ON	0~1
14	WPU_INT_0V95	949mV	900mV~1.03V	36	SW_AFG	ON	0~1
15	3.3V_ACQ1	3.32V	3.2V~3.4V	37	DG_TRIG	OFF	0~1
16	3.3V_ACQ2	3.31V	3.2V~3.4V	38	SW_SPU_S	OFF	0~1
17	5V_DSO_ANALOG	5.01V	4.8V~5.2V	39	SW_COUNTER	ON	0~1
18	3.3V_DSO_ANALOG	3.29V	3.2V~3.4V	40	SW_DVM	ON	0~1
19	5V3_DSO_AFE	5.21V	4.8V~5.3V	41	SPU1.DDR	OK	0~1
20	-5V6_DSO_AFE	-5.6V	-5.8V~-5.4V	42	SPU2.DDR	OK	0~1
21	CH1_Probe	3.52V	24.2mV~3.6V				

Figure 23.6 Board Test Interface

24 Remote Control

The following ways of remote control are supported:

- **User-defined Programming**

Users can program and control the instrument by using the SCPI (Standard Commands for Programmable Instruments) commands. For details about the SCPI commands and programming, refer to *Programming Guide* of this product series.

- **PC software**

Users can use the PC software to send commands to control the instrument remotely. RIGOL Ultra Sigma is recommended. You can download the software from RIGOL official website (<http://www.rigol.com>).

Operation Procedures:

- Set up communication between the instrument and PC.
- Run Ultra Sigma and search for the instrument resource.
- Open the remote command control panel to send commands.

- **Web Control**

This instrument supports Web Control. Connect the instrument to the network, then input the IP address of the instrument into the address bar of the browser of your computer. The web control interface is displayed. Click Web Control to enter the web control page. Then you can view the display of the real-time interface of the instrument. Through the Web Control method, you can migrate the device control to the control terminals (e.g. PC, Mobile, iPad, and other smart terminals) to realize remote control of the instrument. When you first log in to the Web Control, the user name is "admin" and password is "rigol".

This instrument can be connected to the PC via the USB, LAN, or GPIB interface to set up communication and realize remote control through the PC. The remote control can be realized by using SCPI (Standard Commands for Programmable Instruments) commands.

This chapter will illustrate how to use the RIGOL Ultra Sigma software to remotely control the instrument via various interfaces. Note: When communicating with the PC via GPIB, the instrument does not support large data transmission operation such as screen shot and waveform reading.

CAUTION

Before setting up communication, please turn off the instrument to avoid causing damage to the communication interfaces.



24.1 Remote Control via USB

1. Connect the device

Use the USB cable to connect the rear-panel USB DEVICE interface of the instrument to the USB HOST interface of the PC.

2. Search for the device resource

Start up Ultra Sigma and the software will automatically search for the resource currently connected to the PC via the USB interface. You can also click **USB-TMC** to search for the resource.

3. View the device resource

The resources found will appear under the "RIGOL Online Resource" directory, and the model number and USB interface information of the instrument will also be displayed.

4. Control the instrument remotely

Right-click the device resource name and select "SCPI Panel Control" to open the remotely command control panel. Then you can send commands and read data through the panel. For details about the SCPI commands and programming, refer to the Programming Guide of this instrument.

24.2 Remote Control via LAN

1. Connect the device

Use the network cable to connect the instrument to your local area network (LAN).

2. Configure network parameters

Configure the network parameters of the instrument according to "*I/O Setting*".

3. Search for Search device resource

Start up Ultra Sigma and click **LAN** to open the panel as shown in the figure below. Click **Search** and the software searches for the instrument resources currently connected to the LAN and the resources found are displayed at the right section of the window as shown in the figure below. Click **OK** to add it.

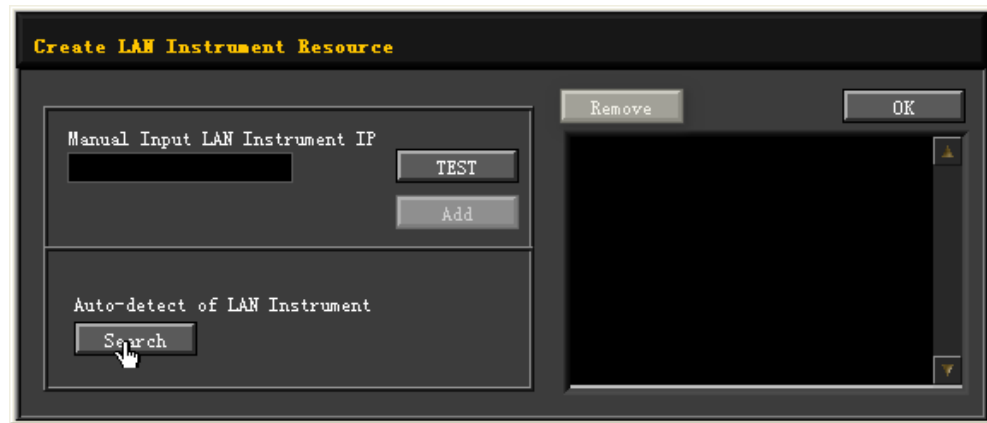

Besides, you can input the IP address of the instrument manually into the text field under "Manual Input LAN Instrument IP", then click **TEST**. If the instrument passes the test, click **ADD** to add the instrument to the LAN instrument resource list in the right section; if the instrument fails the test, please check whether the IP address that you input is correct, or use the auto search method to add the instrument resource.

4. View the device resource

The resources found will appear under the "RIGOL Online Resource" directory.

5. Control the instrument remotely

Right-click the device resource name and select "SCPI Panel Control" to open the remotely command control panel. Then you can send commands and read data through the panel.

6. Load LXI webpage

As this instrument conforms to LXI CORE 2011 DEVICE standards, you can load LXI web page through Ultra Sigma (right-click the instrument resource name and select "LXI-Web"). Various important information about the instrument (including the model, manufacturer, serial number, description, MAC address, and IP address) will be displayed on the web page. You can also directly input the IP address of the instrument in the address bar of the PC browser to load the LXI web page.

24.3 Remote Control via GPIB

1. Connect the device

Use the USB-GPIB interface converter to extend the GPIB interface for the instrument, and then use the GPIB cable to connect the instrument to the PC to realize remote control.

2. Install the driver of GPIB card

Correctly install the driver of the GPIB card which has been connected to the PC.

3. Set the GPIB address

Click or tap the Notification Area at the lower-right corner of the screen, then the **Utility** menu is displayed. Click or tap **IO**, and then click or tap the input field of **GPIB** to input the GPIB address with the pop-up numeric keypad.

4. Search for the device resource

Start Ultra Sigma, and then click **GPIB**. A window is displayed as shown in *Figure 24.1*. Click **Search** and the software searches for the instrument resource currently connected to the PC via the GPIB interface. The resource found is displayed at the right side of the window, as shown in *Figure 24.2*. Click **OK** to add it.



Figure 24.1 Search for the Available Device



Figure 24.2 Confirm the Available Device

5. View the device resource

Click **OK** to go back to the main interface of Ultra Sigma. The searched instrument resource will be displayed under the directory of "RIGOL Online Resource".

6. Control the instrument remotely

Right-click the device resource name. In the displayed menu, select "SCPI Panel Control" to open the programming command control panel. Then you can input commands to send commands and read data.

25 Troubleshooting

1. When I power on the instrument, the instrument stays black and does not display anything.

- a. Check whether the power supply has been connected correctly.
- b. Check whether the power key is really pressed.
- c. Check whether the fuse is blown. If you need to replace the fuse, use only the specified fuse that conforms to the product.
- d. Restart the instrument after finishing the above inspections.
- e. If the problem still persists, please contact RIGOL.

2. No waveform of the signal is displayed on the screen.

- a. Check whether the probe is properly connected to the item under test.
- b. Check whether there are signals generated from the item to be tested (you can connect the probe compensation output signal to the faulty channel to locate the problem, and then determine whether the channel or the item to be tested has a problem).
- c. Resample the signal.
- d. If the problem still persists, please contact RIGOL.

3. The USB storage device cannot be recognized.

- a. Check whether the USB storage device can work normally when connected to other instruments or PC.
- b. Make sure that the USB storage device is FAT32 format and flash type. The instrument doesn't support hardware USB storage device.
- c. After restarting the instrument, insert the USB storage device again to check whether it can work normally.
- d. If the USB storage device still cannot work normally, please contact RIGOL.

4. How do you set the amplitude of the waveform in dBm?

- a. Select the desired channel.
- b. In the channel setting interface, check whether HighZ under **OutputSet** is set to "On". If yes, you cannot set the amplitude of the waveform in dBm at this time. Select "Off" to disable the HighZ, and use the numeric keypad, the arrow keys, and knob to set it to a proper value.

- c. Select the desired waveform, tap the Amplitude menu label, and then input the desired value by using the numeric keypad. Then select the unit "dBm" from the pop-up menu.

5. The touch-enabled operation does not work.

- a. Check whether you have locked the touch screen. If yes, unlock the touch screen.
- b. Check whether the screen or your finger is stained with oil or sweat. If yes, please clean the screen or dry your hands.
- c. Check whether there is a strong magnetic field around the instrument. If the instrument is close to the strong magnetic field (e.g. a magnet), please move the instrument away from the magnet field.
- d. If the problem still persists, please contact RIGOL.

26 Appendix

26.1 Appendix A: Options and Accessories

Order Information	Order No.
Model	
3 GHz, 20 GSa/s, 500 Mpts, 4CH digital oscilloscope	DS70304
5 GHz, 20 GSa/s, 500 Mpts, 4CH digital oscilloscope	DS70504
Standard Accessories	
Power Cord Conforming to the Standard of the Destination Country	— —
USB Cable	— —
4 Passive HighZ Probes (500 MHz)	RP3500A
Recommended Accessories	
Active Differential Probe (3.5 GHz BW)	PVA8350
Active Differential Probe (7 GHz BW)	PVA8700
Current Probe (50 MHz, 30A)	PCA1030
Current Probe (100 MHz, 30A)	PCA2030
Current Probe (10 MHz, 150A)	PCA1150
High-Voltage Differential Probe (70 MHz, 1400 V)	PHA0150
High-Voltage Differential Probe (100 MHz, 1400 V)	PHA1150
USB-GPIB Interface Converter	USB-GPIB
Upgrade Option	
2 Gpts Memory Depth Upgrade Option	DS70000-RL-20
Serial Protocol Analysis Option	
Embedded Serial Bus Trigger and Analysis (RS232/UART, I2C, and SPI)	DS70000-EMBDA
Auto Serial Bus Trigger and Analysis (CAN, CAN-FD, LIN, FlexRay)	DS70000-AUTOA
Audio serial bus trigger and analysis (I2S)	DS70000-AUDIOA
MIL-STD-1553 serial bus trigger and analysis	DS70000-AEROA
Measurement Application Option	
Advanced Eye Diagram and Jitter Analysis (Option)	DS70000-JITTA
Pre-compliance Test Software	
USB2.0 Compliance Test	DS70000-USBC
1000 Base-T/100Base-T Ethernet Pre-compliance Test	DS70000-ENETC
Real-Time Spectrum Analysis (RTSA)	
Real-Time Spectrum Analysis Function	DS70000-RTSA

For all the mainframes, accessories and options, please contact the local office of **RIGOL**.

26.2 Appendix B: Warranty

RIGOL TECHNOLOGIES CO., LTD. (hereinafter referred to as RIGOL) warrants that the product mainframe and product accessories will be free from defects in materials and workmanship within the warranty period. If a product proves defective within the warranty period, RIGOL guarantees free replacement or repair for the defective product.

To get repair service, please contact your nearest RIGOL sales or service office.

There is no other warranty, expressed or implied, except such as is expressly set forth herein or other applicable warranty card. There is no implied warranty of merchantability or fitness for a particular purpose. Under no circumstances shall RIGOL be liable for any consequential, indirect, ensuing, or special damages for any breach of warranty in any case.

HEADQUARTER

RIGOL TECHNOLOGIES CO., LTD.
No.8 Keling Road, New District, Suzhou,
JiangSu, P.R.China
Tel: +86-400620002
Email: info@rigol.com

EUROPE

RIGOL TECHNOLOGIES EU GmbH
Carl-Benz-Str.11
82205 Gilching
Germany
Tel: +49(0)8105-27292-0
Email: info-europe@rigol.com

NORTH AMERICA

RIGOL TECHNOLOGIES, USA INC.
10220 SW Nimbus Ave.
Suite K-7
Portland, OR 97223
Tel: +1-877-4-**RIGOL**-1
Fax: +1-877-4-**RIGOL**-1
Email: info@rigol.com

JAPAN

RIGOL JAPAN CO., LTD.
501, LATORRETTA, 2-37-1,
Numabukuro,
Nakano-Ku, Tokyo, Japan
Tel: +81-3-6262-8932
Fax: +81-3-6262-8933
Email: info-japan@rigol.com

RIGOL® is the trademark of **RIGOL TECHNOLOGIES CO., LTD.** Product information in this document subject to update without notice. For the latest information about **RIGOL's** products, applications and services, please contact local **RIGOL** channel partners or access **RIGOL** official website: www.rigol.com